

# Apache Camel



USER GUIDE

Version 1.6.0

# Table of Contents

	<b>Table of Contents.....</b>	<b>ii</b>
Chapter 1	<b>Introduction .....</b>	<b>1</b>
Chapter 2	<b>Quickstart.....</b>	<b>1</b>
Chapter 3	<b>Getting Started.....</b>	<b>6</b>
Chapter 4	<b>Architecture .....</b>	<b>16</b>
Chapter 5	<b>Enterprise Integration Patterns.....</b>	<b>24</b>
Chapter 6	<b>Cook Book .....</b>	<b>29</b>
Chapter 7	<b>Tutorials.....</b>	<b>76</b>
Chapter 8	<b>Language Appendix.....</b>	<b>174</b>
Chapter 9	<b>Pattern Appendix.....</b>	<b>206</b>
Chapter 10	<b>Component Appendix .....</b>	<b>252</b>
	<b>Index .....</b>	<b>0</b>

# Introduction

Apache Camel is a powerful open source integration framework based on known Enterprise Integration Patterns with powerful Bean Integration.

Camel lets you create the Enterprise Integration Patterns to implement routing and mediation rules in either a Java based Domain Specific Language (or Fluent API), via Spring based Xml Configuration files or via the Scala DSL. This means you get smart completion of routing rules in your IDE whether in your Java, Scala or XML editor.

Apache Camel uses URIs so that it can easily work directly with any kind of Transport or messaging model such as HTTP, ActiveMQ, JMS, JBI, SCA, MINA or CXF Bus API together with working with pluggable Data Format options. Apache Camel is a small library which has minimal dependencies for easy embedding in any Java application. Apache Camel lets you work with the same API regardless which kind of Transport used, so learn the API once and you will be able to interact with all the Components that is provided out-of-the-box.

Apache Camel has powerful Bean Binding and integrated seamless with popular frameworks such as Spring and Guice.

Apache Camel has extensive Testing support allowing you to easily unit test your routes.

Apache Camel can be used as a routing and mediation engine for the following projects:

- Apache ServiceMix which is the most popular and powerful distributed open source ESB and JBI container
- Apache ActiveMQ which is the most popular and powerful open source message broker
- Apache CXF which is a smart web services suite (JAX-WS)
- Apache MINA a networking framework

So don't get the hump, try Camel today! 😊

## CHAPTER 2

••••

# Quickstart

To start using Apache Camel quickly, you can read through some simple examples in this chapter. For readers who would like a more thorough introduction, please skip ahead to Chapter 3.

## WALK THROUGH AN EXAMPLE CODE

This mini-guide takes you through the source code of a simple example.

Camel can be configured either by using Spring or directly in Java - which this example does.

We start with creating a CamelContext - which is a container for Components, Routes etc:

```
CamelContext context = new DefaultCamelContext();
```

There is more than one way of adding a Component to the CamelContext. You can add components implicitly - when we set up the routing - as we do here for the FileComponent:

```
context.addRoutes(new RouteBuilder() {  
  
    public void configure() {  
        from("test-jms:queue:test.queue").to("file://test");  
        // set up a listener on the file component  
        from("file://test").process(new Processor() {  
  
            public void process(Exchange e) {  
                System.out.println("Received exchange: " + e.getIn());  
            }  
        });  
    }  
});
```

or explicitly - as we do here when we add the JMS Component:

```
ConnectionFactory connectionFactory = new  
ActiveMQConnectionFactory("vm://localhost?broker.persistent=false");  
// Note we can explicitly name the component  
context.addComponent("test-jms",  
JmsComponent.jmsComponentAutoAcknowledge(connectionFactory));
```

The above works with any JMS provider. If we know we are using ActiveMQ we can use an even simpler form using the `activeMQComponent()` method while specifying the brokerURL used to connect to ActiveMQ

```
camelContext.addComponent("activemq",
    activeMQComponent("vm://localhost?broker.persistent=false"));
```

In normal use, an external system would be firing messages or events directly into Camel through one of its Components but we are going to use the `ProducerTemplate` which is a really easy way for testing your configuration:

```
ProducerTemplate template = context.createProducerTemplate();
```

Next you **must** start the camel context. If you are using Spring to configure the camel context this is automatically done for you; though if you are using a pure Java approach then you just need to call the `start()` method

```
camelContext.start();
```

This will start all of the configured routing rules.

So after starting the `CamelContext`, we can fire some objects into camel:

```
for (int i = 0; i < 10; i++) {
    template.sendBody("test-jms:queue:test.queue", "Test Message: " + i);
}
```

## WHAT HAPPENS?

From the `ProducerTemplate` - we send objects (in this case text) into the `CamelContext` to the Component `test-jms:queue:test.queue`. These text objects will be converted automatically into JMS Messages and posted to a JMS Queue named `test.queue`. When we set up the Route, we configured the `FileComponent` to listen of the `test.queue`.

The `FileComponent` will take messages off the Queue, and save them to a directory named `test`. Every message will be saved in a file that corresponds to its destination and message id.

Finally, we configured our own listener in the Route - to take notifications from the `FileComponent` and print them out as text.

### That's it!

If you have the time then use 5 more minutes to Walk through another example that demonstrates the Spring DSL (XML based) routing.

## WALK THROUGH ANOTHER EXAMPLE

### Introduction

We continue the walk from Walk through an example. This time we take a closer look at the routing and explains a few pointers so you wont walk into a bear trap, but can enjoy a walk after hours to the local pub for a large beer 😊



## Camel 1.4.0 change

In Camel 1.4.0, CamelTemplate has been marked as `@deprecated`. ProducerTemplate should be used instead and its created from the CamelContext itself.

```
ProducerTemplate template = context.createProducerTemplate();
```

First we take a moment to look at the Enterprise Integration Patterns that is the base pattern catalog for integrations. In particular we focus on the Pipes and filters EIP pattern, that is a central pattern. This is used for: route through a sequence of processing steps, each performing a specific function - much like the Java Servlet Filters.

## Pipes and filters

In this sample we want to process a message in a sequence of steps where each steps can perform their specific function. In our example we have a JMS queue for receiving new orders. When an order is received we need to process it in several steps:

- validate
- register
- send confirm email

This can be created in a route like this:

```
<route>
  <from uri="jms:queue:order"/>
  <pipeline>
    <bean ref="validateOrder"/>
    <bean ref="registerOrder"/>
    <bean ref="sendConfirmEmail"/>
  </pipeline>
</route>
```

Where as the bean `ref` is a reference for a spring bean id, so we define our beans using regular Spring XML as:

```
<bean id="validateOrder" class="com.mycompany.MyOrderValidator"/>
```

Our validator bean is a plain POJO that has no dependencies to Camel what so ever. So you can implement this POJO as you like. Camel uses rather intelligent Bean Binding to invoke your POJO with the payload of the received message. In this example we will **not** dig into this how this happens. You should return to this topic later when you got some hands on experience with Camel how it can easily bind routing using your existing POJO beans.

So what happens in the route above. Well when an order is received from the JMS queue the message is routed like Pipes and filters:

1. payload from the JMS is sent as input to the validateOrder bean



## Pipeline is default

In the route above we specify pipeline but it can be omitted as its default, so you can write the route as:

```
<route>
  <from uri="jms:queue:order" />
  <bean ref="validateOrder" />
  <bean ref="registerOrder" />
  <bean ref="sendConfirmEmail" />
</route>
```

This is commonly used not to state the pipeline.

An example where the pipeline needs to be used, is when using a multicast and "one" of the endpoints to send to (as a logical group) is a pipeline of other endpoints. For example.

```
<route>
  <from uri="jms:queue:order" />
  <multicast>
    <to uri="log:org.company.log.Category" />
    <pipeline>
      <bean ref="validateOrder" />
      <bean ref="registerOrder" />
      <bean ref="sendConfirmEmail" />
    </pipeline>
  </multicast>
</route>
```

The above sends the order (from `jms:queue:order`) to two locations at the same time, our log component, and to the "pipeline" of beans which goes one to the other. If you consider the opposite, sans the `<pipeline>`

```
<route>
  <from uri="jms:queue:order" />
  <multicast>
    <to uri="log:org.company.log.Category" />
    <bean ref="validateOrder" />
    <bean ref="registerOrder" />
    <bean ref="sendConfirmEmail" />
  </multicast>
</route>
```

you would see that multicast would not "flow" the message from one bean to the next, but rather send the order to all 4 endpoints (1x log, 3x bean) in parallel, which is not (for this example) what we want. We need the message to flow to the `validateOrder`, then to the `registerOrder`, then the `sendConfirmEmail` so adding the pipeline, provides this facility.

2. the output from `validateOrder` bean is sent as input to the `registerOrder` bean
3. the output from `registerOrder` bean is sent as input to the `sendConfirmEmail` bean

## Using Camel Components

In the route lets imagine that the registration of the order has to be done by sending data to a TCP socket that could be a big mainframe. As Camel has many Components we will use the camel-mina component that supports TCP connectivity. So we change the route to:

```
<route>
  <from uri="jms:queue:order" />
  <bean ref="validateOrder" />
  <to uri="mina:tcp://mainframeip:4444?textline=true" />
  <bean ref="sendConfirmEmail" />
</route>
```

What we now have in the route is a `to` type that can be used as a direct replacement for the bean type. The steps is now:

1. payload from the JMS is sent as input to the `validateOrder` bean
2. the output from `validateOrder` bean is sent as text to the mainframe using TCP
3. the output from mainframe is sent back as input to the `sendConfirmEmail` bean

What to notice here is that the `to` is not the end of the route (the world 😞) in this example it's used in the middle of the Pipes and filters. In fact we can change the bean types to `to` as well:

```
<route>
  <from uri="jms:queue:order" />
  <to uri="bean:validateOrder" />
  <to uri="mina:tcp://mainframeip:4444?textline=true" />
  <to uri="bean:sendConfirmEmail" />
</route>
```

As the `to` is a generic type we must state in the uri scheme which component it is. So we must write **bean:** for the Bean component that we are using.

## Conclusion

This example was provided to demonstrate the Spring DSL (XML based) as opposed to the pure Java DSL from the first example. And as well to point about that the `to` doesn't have to be the last node in a route graph.

This example is also based on the **in-only** message exchange pattern. What you must understand as well is the **in-out** message exchange pattern, where the caller expects a response. We will look into this in another example.

## See also

- Examples
- Tutorials
- User Guide



# Getting Started with Apache Camel

## THE ENTERPRISE INTEGRATION PATTERNS (EIP) BOOK

The purpose of a "patterns" book is not to advocate new techniques that the authors have invented, but rather to document existing best practices within a particular field. By doing this, the authors of a patterns book hope to spread knowledge of best practices and promote a vocabulary for discussing architectural designs.

One of the most famous patterns books is *Design Patterns: Elements of Reusable Object-oriented Software* by Erich Gamma, Richard Helm, Ralph Johnson and John Vlissides. Some people refer to this as the "gang of four" book, partly to distinguish this book from other books that use "Design Patterns" in their titles and, perhaps, partly because they cannot remember the names of all four authors.

Since the publication of *Design Patterns*, many other patterns books, of varying quality, have been written. One famous patterns book is called *Enterprise Integration Patterns: Designing, Building, and Deploying Messaging Solutions* by Gregor Hohpe and Bobby Woolfe. It is common for people to refer to this book as *EIP*, which is an acronym of its title. As the subtitle of *EIP* suggests, the book focusses on design patterns for asynchronous messaging systems. The book discusses 65 patterns. Each pattern is given a textual name and most are also given a graphical symbol. The graphical symbols are intended to be used in architectural diagrams.

## THE CAMEL PROJECT

Camel (<http://activemq.apache.org/camel/>) is an open-source, Java-based project that is a part of the Apache *ActiveMQ* project. Camel provides a class library that, according to its documentation, can be used to implement 31 design patterns in the *EIP* book. I am not sure why the Camel documentation discusses only 31 of the 65 *EIP* design patterns. Perhaps this is due to incomplete documentation. Or perhaps it means that the Camel project, which is less than 1 year old at the time of writing, is not yet as feature rich as the *EIP* book.

Because Camel implements many of the design patterns in the *EIP* book, it would be a good idea for people who work with Camel to read the *EIP* book.

## ONLINE DOCUMENTATION FOR CAMEL

The Camel project was started in early 2007. At the time of writing, the Camel project is too young for there to be published books available on how to use Camel. Instead, the only source of documentation seems to be the documentation page on the Apache Camel website.

### Problems with Camel's online documentation

Currently, the online documentation for the Apache Camel project suffers from two problems. First, the documentation is incomplete. Second, there is no clearly specified reading order to the documentation. For example, there is no table of contents. Instead, documentation is fragmented over a collection of 60+ web pages, and hypertext links haphazardly tie these web pages to each other. This documentation might suffice as reference material for people already familiar with Camel but it does not qualify as a tutorial for beginners.

The problems with the documentation are unlikely to be due to, say, its author(s) lacking writing ability. Rather, it is more likely that the problems are due to the author(s) lack of time. I expect Camel's documentation will improve over time. I am writing this overview of Camel to partially counter some of the problems that currently afflict the Camel documentation. In particular, this document aims to serve as a (so far, incomplete) "beginner's guide to Camel". As such, this document tries to complement, rather than compete with, the online Camel documentation.

### A useful tip for navigating the online documentation

There is one useful hint I can provide for reading the online Camel documentation. Each documentation page has a logo at the top, and immediately underneath this is a thin reddish bar that contains some hypertext links. The Hypertext links on left side of this reddish bar indicate your position in documentation. For example, If you are on the "Languages" documentation page then the left-hand side of the reddish bar contains the following links.

```
Apache Camel > Documentation > Architecture > Languages
```

As you might expect, clicking on "Apache Camel" takes you back to the home page of the Apache Camel project, and clicking on "Documentation" takes you to the main documentation page. You can interpret the "Architecture" and "Languages" buttons as indicating you are in the "Languages" section of the "Architecture" chapter. Doing this gives you at least some sense of where you are within the documentation. If you are patient then you can spend a few hours clicking on all the hypertext links you can find in the documentation pages, bookmark each page with a hierarchical name (for example, you might bookmark the above page with the name "Camel – Arch – Languages") and then you can use your bookmarks to serve as a primitive table of contents for the online Camel documentation.

## ONLINE JAVADOC DOCUMENTATION

The Apache Camel website provides Javadoc documentation. It is important to note that the Javadoc documentation is spread over several *independent* Javadoc hierarchies rather than being all contained in a single Javadoc hierarchy. In particular, there is one Javadoc hierarchy for the *core* APIs of Camel, and a separate Javadoc hierarchy for each communications technology supported by Camel. For example, if you will be using Camel with ActiveMQ and FTP then you need to look at the Javadoc hierarchies for the core API, ActiveMQ API and FTP API.

## CONCEPTS AND TERMINOLOGY FUNDAMENTAL TO CAMEL

I said in Section 3.1 ("Problems with Camel's online documentation") that the online Camel documentation does not provide a tutorial for beginners. Because of this, in this section I try to explain some of the concepts and terminology that are fundamental to Camel. This section is not a complete Camel tutorial, but it is a first step in that direction.

### Endpoint

The term *endpoint* is often used when talking about inter-process communication. For example, in client-server communication, the client is one endpoint and the server is the other endpoint. Depending on the context, an endpoint might refer to an *address*, such as a host:port pair for TCP-based communication, or it might refer to a *software entity* that is contactable at that address. For example, if somebody uses "www.example.com:80" as an example of an endpoint, they might be referring to the actual port at that host name (that is, an address), or they might be referring to the web server (that is, software contactable at that address). Often, the distinction between the address and software contactable at that address is not an important one.

Some middleware technologies make it possible for several software entities to be contactable at the same physical address. For example, CORBA is an object-oriented, remote-procedure-call (RPC) middleware standard. If a CORBA server process contains several objects then a client can communicate with any of these objects at the same *physical* address (host:port), but a client communicates with a particular object via that object's *logical* address (called an *IOR* in CORBA terminology), which consists of the physical address (host:port) plus an id that uniquely identifies the object within its server process. (An IOR contains some additional information that is not relevant to this present discussion.) When talking about CORBA, some people may use the term "endpoint" to refer to a CORBA server's *physical address*, while other people may use the term to refer to the *logical address* of a single CORBA object, and other people still might use the term to refer to any of the following:

- The physical address (host:port) of the CORBA server process
- The logical address (host:port plus id) of a CORBA object.
- The CORBA server process (a relatively heavyweight software entity)
- A CORBA object (a lightweight software entity)

Because of this, you can see that the term *endpoint* is ambiguous in at least two ways.

First, it is ambiguous because it might refer to an address or to a software entity contactable at that address. Second, it is ambiguous in the *granularity* of what it refers to: a heavyweight versus lightweight software entity, or physical address versus logical address. It is useful to understand that different people use the term *endpoint* in slightly different (and hence ambiguous) ways because Camel's usage of this term might be different to whatever meaning you had previously associated with the term. Camel provides out-of-the-box support for endpoints implemented with many different communication technologies. Here are some examples of the Camel-supported endpoint technologies.

- A JMS queue.
- A web service.
- A file. A file may sound like an unlikely type of endpoint, until you realize that in some systems one application might write information to a file and, later, another application might read that file.
- An FTP server.
- An email address. A client can send a message to an email address, and a server can read an incoming message from a mail server.
- A POJO (plain old Java object).

In a Camel-based application, you create (Camel wrappers around) some endpoints and connect these endpoints with *routes*, which I will discuss later in Section 4.8 ("Routes, RouteBuilders and Java DSL"). Camel defines a Java interface called `Endpoint`. Each Camel-supported endpoint has a class that implements this `Endpoint` interface. As I discussed in Section 3.3 ("Online Javadoc documentation"), Camel provides a separate Javadoc hierarchy for each communications technology supported by Camel. Because of this, you will find documentation on, say, the `JmsEndpoint` class in the JMS Javadoc hierarchy, while documentation for, say, the `FtpEndpoint` class is in the FTP Javadoc hierarchy.

## CamelContext

A `CamelContext` object represents the Camel runtime system. You typically have one `CamelContext` object in an application. A typical application executes the following steps.

1. Create a `CamelContext` object.
2. Add endpoints – and possibly Components, which are discussed in Section 4.5 ("Components") – to the `CamelContext` object.
3. Add routes to the `CamelContext` object to connect the endpoints.
4. Invoke the `start()` operation on the `CamelContext` object. This starts Camel-internal threads that are used to process the sending, receiving and processing of messages in the endpoints.
5. Eventually invoke the `stop()` operation on the `CamelContext` object. Doing this gracefully stops all the endpoints and Camel-internal threads.

Note that the `CamelContext.start()` operation does not block indefinitely.

Rather, it starts threads internal to each `Component` and `Endpoint` and then `start()` returns. Conversely, `CamelContext.stop()` waits for all the threads internal to each `Endpoint` and `Component` to terminate and then `stop()` returns.

If you neglect to call `CamelContext.start()` in your application then messages will not be processed because internal threads will not have been created.

If you neglect to call `CamelContext.stop()` before terminating your application then the application may terminate in an inconsistent state. If you neglect to call `CamelContext.stop()` in a JUnit test then the test may fail due to messages not having had a chance to be fully processed.

## CamelTemplate

Camel used to have a class called `CamelClient`, but this was renamed to be `CamelTemplate` to be similar to a naming convention used in some other open-source projects, such as the `TransactionTemplate` and `JmsTemplate` classes in Spring. The `CamelTemplate` class is a thin wrapper around the `CamelContext` class. It has methods that send a `Message` or `Exchange` – both discussed in Section 4.6 ("Message and Exchange") – to an `Endpoint` – discussed in Section 4.1 ("Endpoint"). This provides a way to enter messages into source endpoints, so that the messages will move along routes – discussed in Section 4.8 ("Routes, RouteBuilders and Java DSL") – to destination endpoints.

## The Meaning of URL, URI, URN and IRI

Some Camel methods take a parameter that is a *URI* string. Many people know that a URI is "something like a URL" but do not properly understand the relationship between URI and URL, or indeed its relationship with other acronyms such as IRI and URN.

Most people are familiar with *URLs* (uniform resource locators), such as "`http://...`", "`ftp://...`", "`mailto:...`". Put simply, a URL specifies the *location* of a resource.

A *URI* (uniform resource identifier) is a URL or a URN. So, to fully understand what URI means, you need to first understand what is a URN.

*URN* is an acronym for *uniform resource name*. There are many "unique identifier" schemes in the world, for example, ISBNs (globally unique for books), social security numbers (unique within a country), customer numbers (unique within a company's customers database) and telephone numbers. Each "unique identifier" scheme has its own notation. A URN is a wrapper for different "unique identifier" schemes. The syntax of a URN is "`urn:<scheme-name>:<unique-identifier>`". A URN uniquely identifies a *resource*, such as a book, person or piece of equipment. By itself, a URN does not specify the *location* of the resource. Instead, it is assumed that a *registry* provides a mapping from a resource's URN to its location. The URN specification does not state what form a registry takes, but it might be a database, a server application, a wall chart or anything else that is convenient. Some hypothetical examples of URNs are "`urn:employee:08765245`", "`urn:customer:uk:3458:hul8`" and "`urn:foo:0000-0000-9E59-0000-5E-2`". The `<scheme-name>` ("employee", "customer" and "foo")

in these examples) part of a URN implicitly defines how to parse and interpret the <unique-identifier> that follows it. An arbitrary URN is meaningless unless: (1) you know the semantics implied by the <scheme-name>, and (2) you have access to the registry appropriate for the <scheme-name>. A registry does not have to be public or globally accessible. For example, "urn:employee:08765245" might be meaningful only within a specific company. To date, URNs are not (yet) as popular as URLs. For this reason, URI is widely misused as a synonym for URL.

*IRI* is an acronym for *internationalized resource identifier*. An IRI is simply an internationalized version of a URI. In particular, a URI can contain letters and digits in the US-ASCII character set, while a IRI can contain those same letters and digits, and *also* European accented characters, Greek letters, Chinese ideograms and so on.

## Components

*Component* is confusing terminology; *EndpointFactory* would have been more appropriate because a *Component* is a factory for creating *Endpoint* instances. For example, if a Camel-based application uses several JMS queues then the application will create one instance of the *JmsComponent* class (which implements the *Component* interface), and then the application invokes the `createEndpoint()` operation on this *JmsComponent* object several times. Each invocation of `JmsComponent.createEndpoint()` creates an instance of the *JmsEndpoint* class (which implements the *Endpoint* interface). Actually, application-level code does not invoke `Component.createEndpoint()` directly. Instead, application-level code normally invokes `CamelContext.getEndpoint()`; internally, the *CamelContext* object finds the desired *Component* object (as I will discuss shortly) and then invokes `createEndpoint()` on it.

Consider the following code.

```
myCamelContext.getEndpoint("pop3://john.smith@mailserv.example.com?password=myPassword");
```

The parameter to `getEndpoint()` is a URI. The URI *prefix* (that is, the part before ".") specifies the name of a component. Internally, the *CamelContext* object maintains a mapping from names of components to *Component* objects. For the URI given in the above example, the *CamelContext* object would probably map the `pop3` prefix to an instance of the *MailComponent* class. Then the *CamelContext* object invokes `createEndpoint("pop3://john.smith@mailserv.example.com?password=myPassword")` on that *MailComponent* object. The `createEndpoint()` operation splits the URI into its component parts and uses these parts to create and configure an *Endpoint* object.

In the previous paragraph, I mentioned that a *CamelContext* object maintains a mapping from component names to *Component* objects. This raises the question of how this map is populated with named *Component* objects. There are two ways of populating the map. The first way is for application-level code to invoke `CamelContext.addComponent(String componentName, Component component)`. The example below shows a single *MailComponent* object being registered in the map under 3 different names.

```
Component mailComponent = new org.apache.camel.component.mail.MailComponent();
myCamelContext.addComponent("pop3", mailComponent);
myCamelContext.addComponent("imap", mailComponent);
myCamelContext.addComponent("smtp", mailComponent);
```

The second (and preferred) way to populate the map of named `Component` objects in the `CamelContext` object is to let the `CamelContext` object perform lazy initialization. This approach relies on developers following a convention when they write a class that implements the `Component` interface. I illustrate the convention by an example. Let's assume you write a class called `com.example.myproject.FooComponent` and you want Camel to automatically recognize this by the name "foo". To do this, you have to write a properties file called "META-INF/services/org/apache/camel/component/foo" (without a ".properties" file extension) that has a single entry in it called `class`, the value of which is the fully-scoped name of your class. This is shown below.

**Listing 1. META-INF/services/org/apache/camel/component/foo**  
`class=com.example.myproject.FooComponent`

If you want Camel to also recognize the class by the name "bar" then you write another properties file in the same directory called "bar" that has the same contents. Once you have written the properties file(s), you create a jar file that contains the `com.example.myproject.FooComponent` class and the properties file(s), and you add this jar file to your `CLASSPATH`. Then, when application-level code invokes `createEndpoint("foo:...")` on a `CamelContext` object, Camel will find the "foo" properties file on the `CLASSPATH`, get the value of the `class` property from that properties file, and use reflection APIs to create an instance of the specified class.

As I said in Section 4.1 ("Endpoint"), Camel provides out-of-the-box support for numerous communication technologies. The out-of-the-box support consists of classes that implement the `Component` interface plus properties files that enable a `CamelContext` object to populate its map of named `Component` objects.

Earlier in this section I gave the following example of calling `CamelContext.getEndpoint()`.

```
myCamelContext.getEndpoint("pop3://john.smith@mailserv.example.com?password=myPassword");
```

When I originally gave that example, I said that the parameter to `getEndpoint()` was a URI. I said that because the online Camel documentation and the Camel source code both claim the parameter is a URI. In reality, the parameter is restricted to being a URL. This is because when Camel extracts the component name from the parameter, it looks for the first ":", which is a simplistic algorithm. To understand why, recall from Section 4.4 ("The Meaning of URL, URI, URN and IRI") that a URI can be a URL or a URN. Now consider the following calls to `getEndpoint`.

```
myCamelContext.getEndpoint("pop3:...");
myCamelContext.getEndpoint("jms:...");
myCamelContext.getEndpoint("urn:foo:...");
myCamelContext.getEndpoint("urn:bar:...");
```

Camel identifies the components in the above example as "pop3", "jms", "urn" and "urn". It would be more useful if the latter components were identified as "urn:foo" and "urn:bar" or, alternatively, as "foo" and "bar" (that is, by skipping over the "urn:" prefix). So, in practice you must identify an endpoint with a URL (a string of the form "<scheme>:...") rather than with a URN (a string of the form "urn:<scheme>:..."). This lack of proper support for URNs means that you should consider the parameter to `getEndpoint()` as being a URL rather than (as claimed) a URI.

## Message and Exchange

The `Message` interface provides an abstraction for a single message, such as a request, reply or exception message.

There are concrete classes that implement the `Message` interface for each Camel-supported communications technology. For example, the `JmsMessage` class provides a JMS-specific implementation of the `Message` interface. The public API of the `Message` interface provides get- and set-style methods to access the *message id*, *body* and individual *header* fields of a message.

The `Exchange` interface provides an abstraction for an exchange of messages, that is, a request message and its corresponding reply or exception message. In Camel terminology, the request, reply and exception messages are called *in*, *out* and *fault* messages.

There are concrete classes that implement the `Exchange` interface for each Camel-supported communications technology. For example, the `JmsExchange` class provides a JMS-specific implementation of the `Exchange` interface. The public API of the `Exchange` interface is quite limited. This is intentional, and it is expected that each class that implements this interface will provide its own technology-specific operations.

Application-level programmers rarely access the `Exchange` interface (or classes that implement it) directly. However, many classes in Camel are generic types that are instantiated on (a class that implements) `Exchange`. Because of this, the `Exchange` interface appears a lot in the generic signatures of classes and methods.

## Processor

The `Processor` interface represents a class that processes a message. The signature of this interface is shown below.

```
Listing 2. Processor
package org.apache.camel;
public interface Processor {
    void process(Exchange exchange) throws Exception;
}
```

Notice that the parameter to the `process()` method is an `Exchange` rather than a `Message`. This provides flexibility. For example, an implementation of this method initially might call `exchange.getIn()` to get the input message and process it. If an error occurs



during processing then the method can call `exchange.setException()`.

An application-level developer might implement the `Processor` interface with a class that executes some business logic. However, there are many classes in the Camel library that implement the `Processor` interface in a way that provides support for a design pattern in the EIP book. For example, `ChoiceProcessor` implements the message router pattern, that is, it uses a cascading if-then-else statement to route a message from an input queue to one of several output queues. Another example is the `FilterProcessor` class which discards messages that do not satisfy a stated *predicate* (that is, condition).

## Routes, RouteBuilders and Java DSL

A *route* is the step-by-step movement of a `Message` from an input queue, through arbitrary types of decision making (such as filters and routers) to a destination queue (if any). Camel provides two ways for an application developer to specify routes. One way is to specify route information in an XML file. A discussion of that approach is outside the scope of this document. The other way is through what Camel calls a Java *DSL* (domain-specific language).

## Introduction to Java DSL

For many people, the term "domain-specific language" implies a compiler or interpreter that can process an input file containing keywords and syntax specific to a particular domain. This is *not* the approach taken by Camel. Camel documentation consistently uses the term "Java DSL" instead of "DSL", but this does not entirely avoid potential confusion. The Camel "Java DSL" is a class library that can be used in a way that looks almost like a DSL, except that it has a bit of Java syntactic baggage. You can see this in the example below. Comments afterwards explain some of the constructs used in the example.

**Listing 3. Example of Camel's "Java DSL"**

```
RouteBuilder builder = new RouteBuilder() {
    public void configure() {
        from("queue:a").filter(header("foo").isEqualTo("bar")).to("queue:b");
        from("queue:c").choice()
            .when(header("foo").isEqualTo("bar")).to("queue:d")
            .when(header("foo").isEqualTo("cheese")).to("queue:e")
            .otherwise().to("queue:f");
    }
};
CamelContext myCamelContext = new DefaultCamelContext();
myCamelContext.addRoutes(builder);
```

The first line in the above example creates an object which is an instance of an anonymous subclass of `RouteBuilder` with the specified `configure()` method.

The `CamelContext.addRoutes(RouterBuilder builder)` method invokes `builder.setContext(this)` – so the `RouteBuilder` object knows which `CamelContext` object it is associated with – and then invokes `builder.configure()`. The body of `configure()` invokes methods such as `from()`, `filter()`, `choice()`,

`when()`, `isEqualTo()`, `otherwise()` and `to()`.

The `RouteBuilder.from(String uri)` method invokes `getEndpoint(uri)` on the `CamelContext` associated with the `RouteBuilder` object to get the specified `Endpoint` and then puts a `FromBuilder` "wrapper" around this `Endpoint`. The `FromBuilder.filter(Predicate predicate)` method creates a `FilterProcessor` object for the `Predicate` (that is, condition) object built from the `header("foo").isEqualTo("bar")` expression. In this way, these operations incrementally build up a `Route` object (with a `RouteBuilder` wrapper around it) and add it to the `CamelContext` object associated with the `RouteBuilder`.

## Critique of Java DSL

The online Camel documentation compares Java DSL favourably against the alternative of configuring routes and endpoints in a XML-based Spring configuration file. In particular, Java DSL is less verbose than its XML counterpart. In addition, many integrated development environments (IDEs) provide an auto-completion feature in their editors. This auto-completion feature works with Java DSL, thereby making it easier for developers to write Java DSL. However, there is another option that the Camel documentation neglects to consider: that of writing a parser that can process DSL stored in, say, an external file. Currently, Camel does not provide such a DSL parser, and I do not know if it is on the "to do" list of the Camel maintainers. I think that a DSL parser would offer a significant benefit over the current Java DSL. In particular, the DSL would have a syntactic definition that could be expressed in a relatively short BNF form. The effort required by a Camel user to learn how to use DSL by reading this BNF would almost certainly be significantly less than the effort currently required to study the API of the `RouterBuilder` classes.

# Architecture

Camel uses a Java based Routing Domain Specific Language (DSL) or an Xml Configuration to configure routing and mediation rules which are added to a CamelContext to implement the various Enterprise Integration Patterns.

At a high level Camel consists of a CamelContext which contains a collection of Component instances. A Component is essentially a factory of Endpoint instances. You can explicitly configure Component instances in Java code or an IoC container like Spring or Guice, or they can be auto-discovered using URIs.

An Endpoint acts rather like a URI or URL in a web application or a Destination in a JMS system; you can communicate with an endpoint; either sending messages to it or consuming messages from it. You can then create a Producer or Consumer on an Endpoint to exchange messages with it.

The DSL makes heavy use of pluggable Languages to create an Expression or Predicate to make a truly powerful DSL which is extensible to the most suitable language depending on your needs. The following languages are supported

- Bean Language
- Constant
- the unified EL from JSP and JSF
- Header
- XPath
- Mvel
- OGNL
- Property
- Scripting Languages such as
  - BeanShell
  - JavaScript
  - Groovy
  - Python
  - PHP
  - Ruby
- Simple
  - File Language
- SQL
- XPath
- XQuery

Most of these languages is also supported used as Annotation Based Expression Language.

For a full details of the individual languages see the Language Appendix

## URIS

Camel makes extensive use of URIs to allow you to refer to endpoints which are lazily created by a Component if you refer to them within Routes

### Current Supported URIs

Component / ArtifactId / URI	Description
ActiveMQ / activemq-camel <code>activemq:[topic:]destinationName</code>	For JMS Messaging with Apache ActiveMQ
ActiveMQ Journal / activemq-core <code>activemq.journal:directory-on-filesystem</code>	Uses ActiveMQ's fast disk journaling implementation to store message bodies in a rolling log file
AMQP / camel-amqp <code>amqp:[topic:]destinationName</code>	For Messaging with AMQP protocol
Atom / camel-atom <code>atom:uri</code>	Working with Apache Abdera for atom integration, such as consuming an atom feed.
Bean / camel-core <code>bean:beanName [ ?methodName=someMethod ]</code>	Uses the Bean Binding to bind message exchanges to beans in the Registry. Is also used for exposing and invoking POJO (Plain Old Java Objects).
Browse / camel-core <code>browse:someName</code>	Provides a simple BrowsableEndpoint which can be useful for testing, visualisation tools or debugging. The exchanges sent to the endpoint are all available to be browsed.
Cometd / camel-cometd <code>cometd://host:port/channelname</code>	Used to deliver messages using the jetty cometd implementation of the bayeux protocol
CXF / camel-cxf <code>cxf:address[?serviceClass=...]</code>	Working with Apache CXF for web services integration

<b>DataSet / camel-core</b>	For load & soak testing the DataSet provides a way to create huge numbers of messages for sending to Components or asserting that they are consumed correctly
<code>dataset:name</code>	
<b>Direct / camel-core</b>	Direct invocation of the consumer from the producer so that single threaded (non-SEDA) in VM invocation is performed
<code>direct:name</code>	
<b>Esper / camel-esper in camel-extra</b>	Working with the Esper Library for Event Stream Processing
<code>esper:name</code>	
<b>Event / camel-spring</b>	Working with Spring ApplicationEvents
<code>event://default</code> <code>spring-event://default</code>	
<b>File / camel-core</b>	Sending messages to a file or polling a file or directory
<code>file://nameOfFileOrDirectory</code>	
<b>FIX / camel-fix in FUSE</b>	Sends or receives messages using the FIX protocol
<code>fix://configurationResource</code>	
<b>Flatpack / camel-flatpack</b>	Processing fixed width or delimited files or messages using the FlatPack library
<code>flatpack:[fixed delim]:configFile</code>	
<b>Freemarker / camel-freemarker</b>	Generates a response using a Freemarker template
<code>freemarker:someTemplateResource</code>	
<b>FTP / camel-ftp</b>	Sending and receiving files over FTP
<code>ftp://host[:port]/fileName</code>	
<b>Hibernate / camel-hibernate in camel-extra</b>	For using a database as a queue via the Hibernate library
<code>hibernate://entityName</code>	
<b>HL7 / camel-hl7</b>	For working with the HL7 MLLP protocol and the HL7 model using the HAPI library
<code>mina:tcp://hostname[:port]</code>	

<b>HTTP / camel-http</b>	For calling out to external HTTP servers
<code>http://hostname[:port]</code>	
<b>iBatis / camel-ibatis</b>	Performs a query, poll, insert, update or delete in a relational database using Apache iBatis
<code>ibatis://sqlOperationName</code>	
<b>IMap / camel-mail</b>	Receiving email using IMap
<code>imap://hostname[:port]</code>	
<b>IRC / camel-irc</b>	For IRC communication
<code>irc:host[:port]/#room</code>	
<b>JavaSpace / camel-javaspaces in FUSE</b>	Sending and receiving messages through JavaSpace
<code>javaspace:jini://host?spaceName=mySpace?...</code>	
<b>JBoss / servicemix-camel</b>	For JBI integration such as working with Apache ServiceMix
<code>jbi:serviceName</code>	
<b>JCR / camel-jcr</b>	Storing a message in a JCR (JSR-170) compliant repository like Apache Jackrabbit
<code>jcr://user:password@repository/path/to/node</code>	
<b>JDBC / camel-jdbc</b>	For performing JDBC queries and operations
<code>jdbc:dataSourceName?options</code>	
<b>Jetty / camel-jetty</b>	For exposing services over HTTP
<code>jetty:url</code>	
<b>JMS / camel-jms</b>	Working with JMS providers
<code>jms:[topic:]destinationName</code>	
<b>JPA / camel-jpa</b>	For using a database as a queue via the JPA specification for working with OpenJPA, Hibernate or TopLink
<code>jpa://entityName</code>	
<b>JT/400 / camel-jt400</b>	For integrating with data queues on an AS/400 (aka System i, IBM i, i5, ...) system
<code>jt400://user:pwd@system/&lt;path_to_dtaq&gt;</code>	

## LDAP / camel-ldap

```
ldap:host[:port]?base=...[&scope=<scope>]
```

Performing searches on LDAP servers (<scope> must be one of object|onelevel|subtree)

## List / camel-core

```
list:someName
```

**deprecated** Provides a simple `BrowsableEndpoint` which can be useful for testing, visualisation tools or debugging. The exchanges sent to the endpoint are all available to be browsed.

## Log / camel-core

```
log:loggingCategory[?level=ERROR]
```

Uses Jakarta Commons Logging to log the message exchange to some underlying logging system like log4j

## Mail / camel-mail

```
mail://user-info@host:port
```

Sending and receiving email

## MINA / camel-mina

```
[tcp|udp|multicast]:host[:port]
```

Working with Apache MINA

## Mock / camel-core

```
mock:name
```

For testing routes and mediation rules using mocks

## MSMQ / camel-msmq in FUSE

```
msmq:msmqQueueName
```

Sending and receiving messages with Microsoft Message Queuing

## MSV / camel-msv

```
msv:someLocalOrRemoteResource
```

Validates the payload of a message using the MSV Library

## Multicast / camel-mina

```
multicast://host:port
```

Working with TCP protocols using Apache MINA

## Pojo / camel-core

```
pojo:name
```

**Deprecated.** It is now an alias to the Bean component.

## POP / camel-mail

```
pop3://user-info@host:port
```

Receiving email using POP3 and JavaMail

## Quartz / camel-quartz

```
quartz://groupName/timerName
```

Provides a scheduled delivery of messages using the Quartz scheduler

Queue / camel-core

```
queue:name
```

**Deprecated.** It is now an alias to the SEDA component.

Ref / camel-core

```
ref:name
```

Component for lookup of existing endpoints bound in the Registry.

Restlet / camel-restlet

```
restlet:restletUrl[?options]
```

Component for consuming and producing Restful resources using Restlet

RMI / camel-rmi

```
rmi://host[:port]
```

Working with RMI

RNC / camel-jing

```
rnc:/relativeOrAbsoluteUri
```

Validates the payload of a message using RelaxNG Compact Syntax

RNG / camel-jing

```
rng:/relativeOrAbsoluteUri
```

Validates the payload of a message using RelaxNG

RSS / camel-rss

```
rss:uri
```

Working with ROME for RSS integration, such as consuming an RSS feed.

SEDA / camel-core

```
seda:name
```

Used to deliver messages to a `java.util.concurrent.BlockingQueue`, useful when creating SEDA style processing pipelines within the same `CamelContext`

SFTP / camel-ftp

```
sftp://host[:port]/fileName
```

Sending and receiving files over SFTP

Smooks / camel-smooks in camel-extra

```
unmarshal(edi)
```

For working with EDI parsing using the Smooks library

SMTP / camel-mail

```
smtp://user-info@host[:port]
```

Sending email using SMTP and JavaMail

SpringIntegration / camel-spring-integration

```
spring-integration:defaultChannelName
```

The bridge component of Camel and Spring Integration



### SQL / camel-sql

```
sql:select * from table where id=#
```

Performing SQL queries using JDBC

### Stream / camel-stream

```
stream:[in|out|err|file]
```

Read or write to an input/output/error/file stream rather like unix pipes

### StringTemplate / camel-stringtemplate

```
string-template:someTemplateResource
```

Generates a response using a String Template

### TCP / camel-mina

```
tcp://host:port
```

Working with TCP protocols using Apache MINA

### Test / camel-spring

```
test:expectedMessagesEndpointUri
```

Creates a Mock endpoint which expects to receive all the message bodies that could be polled from the given underlying endpoint

### Timer / camel-core

```
timer://name
```

A timer endpoint

### UDP / camel-mina

```
udp://host:port
```

Working with UDP protocols using Apache MINA

### Validation / camel-spring

```
validation:someLocalOrRemoteResource
```

Validates the payload of a message using XML Schema and JAXP Validation

### Velocity / camel-velocity

```
velocity:someTemplateResource
```

Generates a response using an Apache Velocity template

### VM / camel-core

```
vm:name
```

Used to deliver messages to a `java.util.concurrent.BlockingQueue`, useful when creating SEDA style processing pipelines within the same JVM

### XMPP / camel-xmpp

```
xmpp://host:port/room
```

Working with XMPP and Jabber

### XQuery / camel-saxon

```
xquery:someXQueryResource
```

Generates a response using an XQuery template

XSLT / camel-spring

```
xslt:someTemplateResource
```

Generates a response using an XSLT template

---

For a full details of the individual components see the Component Appendix





# Enterprise Integration Patterns

Camel supports most of the Enterprise Integration Patterns from the excellent book of the same name by Gregor Hohpe and Bobby Woolf. Its a highly recommended book, particularly for users of Camel.



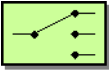
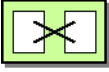

## PATTERN INDEX

There now follows a list of the Enterprise Integration Patterns from the book along with examples of the various patterns using Apache Camel

### Messaging Systems

	Message Channel	How does one application communicate with another using messaging?
	Message	How can two applications connected by a message channel exchange a piece of information?
	Pipes and Filters	How can we perform complex processing on a message while maintaining independence and flexibility?
	Message Router	How can you decouple individual processing steps so that messages can be passed to different filters depending on a set of conditions?
	Message Translator	How can systems using different data formats communicate with each other using messaging?
	Message Endpoint	How does an application connect to a messaging channel to send and receive messages?



## Messaging Channels

	Point to Point Channel	How can the caller be sure that exactly one receiver will receive the document or perform the call?
	Publish Subscribe Channel	How can the sender broadcast an event to all interested receivers?
	Dead Letter Channel	What will the messaging system do with a message it cannot deliver?
	Guaranteed Delivery	How can the sender make sure that a message will be delivered, even if the messaging system fails?
	Message Bus	What is an architecture that enables separate applications to work together, but in a de-coupled fashion such that applications can be easily added or removed without affecting the others?

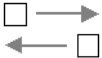
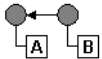
## Message Construction

	Event Message	How can messaging be used to transmit events from one application to another?
	Request Reply	When an application sends a message, how can it get a response from the receiver?
	Correlation Identifier	How does a requestor that has received a reply know which request this is the reply for?

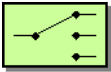
## Message Routing

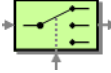
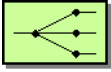
	Content Based Router	How do we handle a situation where the implementation of a single logical function (e.g., inventory check) is spread across multiple physical systems?
	Message Filter	How can a component avoid receiving uninteresting messages?
	Dynamic Router	How can you avoid the dependency of the router on all possible destinations while maintaining its efficiency?
	Recipient List	How do we route a message to a list of (static or dynamically) specified recipients?

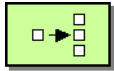

Splitter

How can we process a message if it contains multiple elements, each of which may have to be processed in a different way?

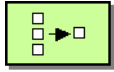

Aggregator

How do we combine the results of individual, but related messages so that they can be processed as a whole?

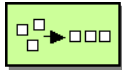

Resequencer

How can we get a stream of related but out-of-sequence messages back into the correct order?

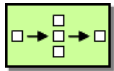

Composed Message Processor

How can you maintain the overall message flow when processing a message consisting of multiple elements, each of which may require different processing?

Scatter-Gather

How do you maintain the overall message flow when a message needs to be sent to multiple recipients, each of which may send a reply?

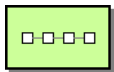

Routing Slip

How do we route a message consecutively through a series of processing steps when the sequence of steps is not known at design-time and may vary for each message?

Throttler

How can I throttle messages to ensure that a specific endpoint does not get overloaded, or we don't exceed an agreed SLA with some external service?

Delayer

How can I delay the sending of a message?

Load Balancer

How can I balance load across a number of endpoints?

Multicast

How can I route a message to a number of endpoints at the same time?

Loop

How can I repeat processing a message in a loop?

## Message Transformation

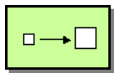

Content Enricher

How do we communicate with another system if the message originator does not have all the required data items available?

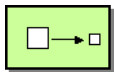

Content Filter

How do you simplify dealing with a large message, when you are interested only in a few data items?

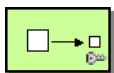

Claim Check

How can we reduce the data volume of message sent across the system without sacrificing information content?

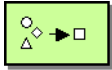

Normalizer

How do you process messages that are semantically equivalent, but arrive in a different format?

---

## Messaging Endpoints

Messaging Mapper

How do you move data between domain objects and the messaging infrastructure while keeping the two independent of each other?

---

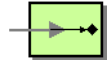

Event Driven Consumer

How can an application automatically consume messages as they become available?

---

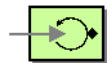

Polling Consumer

How can an application consume a message when the application is ready?

---

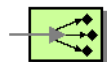

Competing Consumers

How can a messaging client process multiple messages concurrently?

---

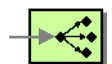

Message Dispatcher

How can multiple consumers on a single channel coordinate their message processing?

---

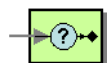

Selective Consumer

How can a message consumer select which messages it wishes to receive?

---

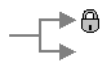

Durable Subscriber

How can a subscriber avoid missing messages while it's not listening for them?

---

Idempotent Consumer

How can a message receiver deal with duplicate messages?

---

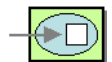

Transactional Client

How can a client control its transactions with the messaging system?

---

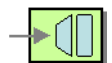

Messaging Gateway

How do you encapsulate access to the messaging system from the rest of the application?

---

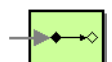

Service Activator

How can an application design a service to be invoked both via various messaging technologies and via non-messaging techniques?

---

## System Management

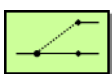

Detour

How can you route a message through intermediate steps to perform validation, testing or debugging functions?

---



Wire  
Tap

How do you inspect messages that travel on a point-to-point channel?

---

For a full breakdown of each pattern see the [Book Pattern Appendix](#)

This document describes various recipes for working with Camel

- Bean Integration describes how to work with beans and Camel in a loosely coupled way so that your beans do not have to depend on any Camel APIs
  - Annotation Based Expression Language binds expressions to method parameters
  - Bean Binding defines which methods are invoked and how the Message is converted into the parameters of the method when it is invoked
  - Bean Injection for injecting Camel related resources into your POJOs
  - Parameter Binding Annotations for extracting various headers, properties or payloads from a Message
  - POJO Consuming for consuming and possibly routing messages from Camel
  - POJO Producing for producing camel messages from your POJOs
  - RecipientList Annotation for creating a Recipient List from a POJO method
  - Using Exchange Pattern Annotations describes how pattern annotations can be used to change the behaviour of method invocations
- Hiding Middleware describes how to avoid your business logic being coupled to any particular middleware APIs allowing you to easily switch from in JVM SEDA to JMS, ActiveMQ, Hibernate, JPA, JDBC, iBatis or JavaSpace etc.
- Visualisation describes how to visualise your Enterprise Integration Patterns to help you understand your routing rules
- Business Activity Monitoring (BAM) for monitoring business processes across systems
- Extract Transform Load (ETL) to load data into systems or databases
- Testing for testing distributed and asynchronous systems using a messaging approach
  - Camel Test for creating test cases using a single Java class for all your configuration and routing
  - Spring Testing uses Spring Test together with either XML or Java Config to dependency inject your test classes
  - Guice uses Guice to dependency inject your test classes
- Templating is a great way to create service stubs to be able to test your system without some back end system.
- Database for working with databases
- Parallel Processing and Ordering on how using parallel processing and SEDA or JMS based load balancing can be achieved.
- Asynchronous Processing in Camel Routes.
- Implementing Virtual Topics on other JMS providers shows how to get the effect of Virtual Topics and avoid issues with JMS durable topics
- Camel Transport for CXF describes how to put the Camel context into the CXF transport layer.



## BEAN INTEGRATION

Camel supports the integration of beans and POJOs in a number of ways

### Bean Binding

Whenever Camel invokes a bean method, either via the Bean component, Spring Remoting or POJO Consuming then the Bean Binding mechanism is used to figure out what method to use (if it is not explicit) and how to bind the Message to the parameters possibly using the Parameter Binding Annotations

### Annotations

If a bean is defined in Spring XML or scanned using the Spring 2.5 component scanning mechanism and a **<camelContext>** is used or a CamelBeanPostProcessor then we process a number of Camel annotations to do various things such as injecting resources or producing, consuming or routing messages.

- POJO Consuming to consume and possibly route messages from Camel
- POJO Producing to make it easy to produce camel messages from your POJOs
- RecipientList Annotation for creating a Recipient List from a POJO method
- Bean Injection to inject Camel related resources into your POJOs
- Using Exchange Pattern Annotations describes how the pattern annotations can be used to change the behaviour of method invocations with Spring Remoting or POJO Producing

### Spring Remoting

We support a Spring Remoting provider which uses Camel as the underlying transport mechanism. The nice thing about this approach is we can use any of the Camel transport Components to communicate between beans. It also means we can use Content Based Router and the other Enterprise Integration Patterns in between the beans; in particular we can use Message Translator to be able to convert what the on-the-wire messages look like in addition to adding various headers and so forth.

### Bean Component

The Bean component supports the creation of a proxy via ProxyHelper to a Java interface; which the implementation just sends a message containing a BeanInvocation to some Camel endpoint.

Then there is a server side implementation which consumes a message and uses the Bean Binding to bind the message to invoke a method passing in its parameters.

## Annotation Based Expression Language

You can also use any of the Languages supported in Camel to bind expressions to method parameters when using Bean Integration. For example you can use any of these annotations:

Annotation	Description
@Bean	Inject a Bean expression
@BeanShell	Inject a BeanShell expression
@Constant	Inject a Constant expression
@EL	Inject an EL expression
@Groovy	Inject a Groovy expression
@Header	Inject a Header expression
@JavaScript	Inject a JavaScript expression
@OGNL	Inject an OGNL expression
@PHP	Inject a PHP expression
@Python	Inject a Python expression
@Ruby	Inject a Ruby expression
@Simple	Inject an Simple expression
@XPath	Inject an XPath expression
@XQuery	Inject an XQuery expression

### Example:

```
public class Foo {  
  
    @MessageDriven(uri = "activemq:my.queue")  
    public void doSomething(@XPath("/foo/bar/text()") String correlationID, @Body  
String body) {  
        // process the inbound message here  
    }  
}
```

### Advanced example using @Bean

And an example of using the the @Bean binding annotation, where you can use a POJO where you can do whatever java code you like:

```

public class Foo {

    @MessageDriven(uri = "activemq:my.queue")
    public void doSomething(@Bean("myCorrelationIdGenerator") String correlationID,
@Body String body) {
        // process the inbound message here
    }
}

```

And then we can have a spring bean with the id **myCorrelationIdGenerator** where we can compute the id.

```

public class MyIdGenerator {

    private UserManager userManager;

    public String generate(@Header(name = "user") String user, @Body String payload)
throws Exception {
        User user = userManager.lookupUser(user);
        String userId = user.getPrimaryId();
        String id = userId + generateHashCodeForPayload(payload);
        return id;
    }
}

```

The POJO MyIdGenerator has one public method that accepts two parameters. However we have also annotated this one with the `@Header` and `@Body` annotation to help Camel know what to bind here from the Message from the Exchange being processed.

Of course this could be simplified a lot if you for instance just have a simple id generator. But we wanted to demonstrate that you can use the Bean Binding annotations anywhere.

```

public class MySimpleIdGenerator {

    public static int generate() {
        // generate a unique id
        return 123;
    }
}

```

And finally we just need to remember to have our bean registered in the Spring Registry:

```

<bean id="myCorrelationIdGenerator" class="com.mycompany.MyIdGenerator"/>

```

## Example using Groovy

In this example we have an Exchange that has a User object stored in the in header. This User object has methods to get some user information. We want to use Groovy to inject an expression that extracts and concatenates the fullname of the user into the `fullName` parameter.

```

public void doSomething(@Groovy("$request.header['user'].firstName
$request.header['user'].familyName) String fullName, @Body String body) {

```

```
} // process the inbound message here
```

Groovy supports GStrings that is like a template where we can insert \$ placeholders that will be evaluated by Groovy.

## Bean Binding

The Bean Binding in Camel defines both which methods are invoked and also how the Message is converted into the parameters of the method when it is invoked.

## Choosing the method to invoke

The binding of a Camel Message to a bean method call can occur in different ways

- the method name can be specified explicitly in the DSL or when using POJO Consuming
- if the bean can be converted to a Processor using the Type Converter mechanism then this is used to process the message. This mechanism is used by the ActiveMQ component to allow any JMS MessageListener to be invoked directly by Camel without having to write any integration glue code. You can use the same mechanism to integrate Camel into any other messaging/remoting frameworks.
- if the body of the message can be converted to a BeanInvocation (the default payload used by the ProxyHelper) - then that its used to invoke the method and pass the arguments
- if the message contains the header **org.apache.camel.MethodName** then that method is invoked, converting the body to whatever the argument is to the method
- otherwise the type of the method body is used to try find a method which matches; an error is thrown if a single method cannot be chosen unambiguously.
- you can also use Exchange as the parameter itself, but then the return type must be void.

By default the return value is set on the outbound message body.

## Binding Annotations

You can use the Parameter Binding Annotations to customize how parameter values are created from the Message

## Examples

For example a Bean such as:

```
public class Bar {
```

```

public String doSomething(String body) {
    // process the in body and return whatever you want
    return "Bye World";
}

```

Or the Exchange example. Notice that the return type must be **void**:

```

public class Bar {

    public void doSomething(Exchange exchange) {
        // process the exchange
        exchange.getIn().setBody("Bye World");
    }
}

```

For example you could use POJO Consuming to write a bean like this

```

public class Foo {

    @MessageDriven(uri = "activemq:my.queue")
    public void doSomething(String body) {
        // process the inbound message here
    }
}

```

Here Camel will subscribe to an ActiveMQ queue, then convert the message payload to a String (so dealing with TextMessage, ObjectMessage and BytesMessage in JMS), then process this method.

## Bean Injection

We support the injection of various resources using `@EndpointInject`. This can be used to inject

- Endpoint instances which can be used for testing when used with Mock endpoints; see the Spring Testing for an example.
- ProducerTemplate instances for POJO Producing
- client side proxies for POJO Producing which is a simple approach to Spring Remoting

## Parameter Binding Annotations

Annotations can be used to define an Expression or to extract various headers, properties or payloads from a Message when invoking a bean method (see Bean Integration for more detail of how to invoke bean methods) together with being useful to help disambiguate which method to invoke.

If no annotations are used then Camel assumes that a single parameter is the body of the message. Camel will then use the Type Converter mechanism to convert from the expression value to the actual type of the parameter.

The core annotations are as follows



### @MessageDriven requires camel-spring

Using the @MessageDriven annotations requires **camel-spring** that uses the `org.apache.camel.spring.CamelBeanPostProcessor` to perform the setup for this consumer and the needed bean bindings.



### camel-core

The annotations below are all part of **camel-core** and thus does not require **camel-spring** or Spring. These annotations can be used with the Bean component or when invoking beans in the DSL

Annotation	Meaning	Parameter
@Body	To bind to an inbound message body	
@ExchangeException	To bind to an Exception set on the exchange ( <b>Camel 2.0</b> )	
@Header	To bind to an inbound message header	String name of the header
@Headers	To bind to the Map of the inbound message headers	
@OutHeaders	To bind to the Map of the outbound message headers	
@Property	To bind to a named property on the exchange	String name of the property
@Properties	To bind to the property map on the exchange	

The follow annotations @Headers, @OutHeaders and @Properties binds to the backing `java.util.Map` so you can alter the content of these maps directly, for instance using the `put` method to add a new entry. See the OrderService class at Exception Clause for such an example.

### Example

In this example below we have a @MessageDriven consumer that consumes JMS messages from the activemq queue. We use the @Header and @Body parameter binding annotations to bind from the JMSMessage to the method parameters.

```

public class Foo {

    @MessageDriven(uri = "activemq:my.queue")
    public void doSomething(@Header(name = "JMSCorrelationID") String correlationID,
@Body String body) {
        // process the inbound message here
    }
}

```

In the above Camel will extract the value of `Message.getJMSCorrelationID()`, then using the Type Converter to adapt the value to the type of the parameter if required - it will inject the parameter value for the **correlationID** parameter. Then the payload of the message will be converted to a `String` and injected into the **body** parameter.

You don't need to use the `@MessageDriven` annotation; as you could use the Camel DSL to route to the beans method

## Using the DSL to invoke the bean method

Here is another example which does not use POJO Consuming annotations but instead uses the DSL to route messages to the bean method

```

public class Foo {
    public void doSomething(@Header(name = "JMSCorrelationID") String correlationID,
@Body String body) {
        // process the inbound message here
    }
}

```

The routing DSL then looks like this

```

from("activemq:someQueue").
to("bean:myBean");

```

Here **myBean** would be looked up in the Registry (such as JNDI or the Spring ApplicationContext), then the body of the message would be used to try figure out what method to call.

If you want to be explicit you can use

```

from("activemq:someQueue").
to("bean:myBean?methodName=doSomething");

```

And here we have a nifty example for you to show some great power in Camel. You can mix and match the annotations with the normal parameters, so we can have this example with annotations and the Exchange also:

```

public void doSomething(@Header(name = "user") String user, @Body String body,
Exchange exchange) {
    exchange.getIn().setBody(body + "MyBean");
}

```

## Annotation Based Expression Language

You can also use any of the Languages supported in Camel to bind expressions to method parameters when using Bean Integration. For example you can use any of these annotations:

Annotation	Description
@Bean	Inject a Bean expression
@BeanShell	Inject a BeanShell expression
@Constant	Inject a Constant expression
@EL	Inject an EL expression
@Groovy	Inject a Groovy expression
@Header	Inject a Header expression
@JavaScript	Inject a JavaScript expression
@OGNL	Inject an OGNL expression
@PHP	Inject a PHP expression
@Python	Inject a Python expression
@Ruby	Inject a Ruby expression
@Simple	Inject an Simple expression
@XPath	Inject an XPath expression
@XQuery	Inject an XQuery expression

### Example:

```
public class Foo {  
  
    @MessageDriven(uri = "activemq:my.queue")  
    public void doSomething(@XPath("/foo/bar/text()") String correlationID, @Body  
String body) {  
        // process the inbound message here  
    }  
}
```

### Advanced example using @Bean

And an example of using the the @Bean binding annotation, where you can use a POJO where you can do whatever java code you like:



```

public class Foo {

    @MessageDriven(uri = "activemq:my.queue")
    public void doSomething(@Bean("myCorrelationIdGenerator") String correlationID,
@Body String body) {
        // process the inbound message here
    }
}

```

And then we can have a spring bean with the id **myCorrelationIdGenerator** where we can compute the id.

```

public class MyIdGenerator {

    private UserManager userManager;

    public String generate(@Header(name = "user") String user, @Body String payload)
throws Exception {
        User user = userManager.lookupUser(user);
        String userId = user.getPrimaryId();
        String id = userId + generateHashCodeForPayload(payload);
        return id;
    }
}

```

The POJO MyIdGenerator has one public method that accepts two parameters. However we have also annotated this one with the `@Header` and `@Body` annotation to help Camel know what to bind here from the Message from the Exchange being processed.

Of course this could be simplified a lot if you for instance just have a simple id generator. But we wanted to demonstrate that you can use the Bean Binding annotations anywhere.

```

public class MySimpleIdGenerator {

    public static int generate() {
        // generate a unique id
        return 123;
    }
}

```

And finally we just need to remember to have our bean registered in the Spring Registry:

```

<bean id="myCorrelationIdGenerator" class="com.mycompany.MyIdGenerator"/>

```

## Example using Groovy

In this example we have an Exchange that has a User object stored in the in header. This User object has methods to get some user information. We want to use Groovy to inject an expression that extracts and concatenates the fullname of the user into the `fullName` parameter.

```

public void doSomething(@Groovy('$request.header['user'].firstName
$request.header['user'].familyName) String fullName, @Body String body) {

```

```
        // process the inbound message here
    }
```

Groovy supports GStrings that is like a template where we can insert \$ placeholders that will be evaluated by Groovy.

## @MessageDriven or @Consume

To consume a message you use either the @MessageDriven annotation or from 1.5.0 the @Consume annotation to mark a particular method of a bean as being a consumer method. The uri of the annotation defines the Camel Endpoint to consume from.

e.g. lets invoke the onCheese() method with the String body of the inbound JMS message from ActiveMQ on the cheese queue; this will use the Type Converter to convert the JMS ObjectMessage or BytesMessage to a String - or just use a TextMessage from JMS

```
public class Foo {

    @MessageDriven(uri="activemq:cheese")
    public void onCheese(String name) {
        ...
    }
}
```

The Bean Binding is then used to convert the inbound Message to the parameter list used to invoke the method .

What this does is basically create a route that looks kinda like this

```
from(uri).bean(theBean, "methodName");
```

## Using an explicit route

If you want to invoke a bean method from many different endpoints or within different complex routes in different circumstances you can just use the normal routing DSL or the Spring XML configuration file.

For example

```
from(uri).beanRef("myBean", "methodName");
```

which will then look up in the Registry and find the bean and invoke the given bean name. (You can omit the method name and have Camel figure out the right method based on the method annotations and body type).

## Use the Bean endpoint

You can always use the bean endpoint

```
from(uri).to("bean:myBean/methodName");
```

## Which approach to use?

Using the `@MessageDriven`/`@Consume` annotations are simpler when you are creating a simple route with a single well defined input URI.

However if you require more complex routes or the same bean method needs to be invoked from many places then please use the routing DSL as shown above.

There are two different ways to send messages to any Camel Endpoint from a POJO

## @EndpointInject

To allow sending of messages from POJOs you can use `@EndpointInject()` annotation. This will inject either a `ProducerTemplate` or `CamelTemplate` so that the bean can send message exchanges.

e.g. lets send a message to the **foo.bar** queue in ActiveMQ at some point

```
public class Foo {
    @EndpointInject(uri="activemq:foo.bar")
    ProducerTemplate producer;

    public void doSomething() {
        if (whatever) {
            producer.sendBody("<hello>world!</hello>");
        }
    }
}
```

The downside of this is that your code is now dependent on a Camel API, the `ProducerTemplate`. The next section describes how to remove this

## Hiding the Camel APIs from your code using @Produce

We recommend Hiding Middleware APIs from your application code so the next option might be more suitable.

You can add the `@Produce` annotation to an injection point (a field or property setter) using a `ProducerTemplate` **or** using some interface you use in your business logic. e.g.

```
public interface MyListener {
    String sayHello(String name);
}

public class MyBean {
    @Produce(uri = "activemq:foo")
    protected MyListener producer;

    public void doSomething() {
```

```

    // lets send a message
    String response = producer.sayHello("James");
}
}

```

Here Camel will automatically inject a smart client side proxy at the `@Produce` annotation - an instance of the `MyListener` instance. When we invoke methods on this interface the method call is turned into an object and using the Camel Spring Remoting mechanism it is sent to the endpoint - in this case the ActiveMQ endpoint to queue **foo**; then the caller blocks for a response.

If you want to make asynchronous message sends then use an `@InOnly` annotation on the injection point.

## @RECIPIENTLIST ANNOTATION

As of 1.5.0 we now support the use of `@RecipientList` on a bean method to easily create a dynamic Recipient List using a Java method.

### Simple Example using @Consume

```

package com.acme.foo;

public class RouterBean {

    @Consume(uri = "activemq:foo")
    @RecipientList
    public String[] route(String body) {
        return new String[]{"activemq:bar", "activemq:whatnot"};
    }
}

```

For example if the above bean is configured in Spring when using a `<camelContext>` element as follows

```

<?xml version="1.0" encoding="UTF-8"?>
<beans xmlns="http://www.springframework.org/schema/beans"
       xmlns:xsi="http://www.w3.org/2001/XMLSchema-instance"
       xsi:schemaLocation="
           http://www.springframework.org/schema/beans http://www.springframework.org/
           schema/beans/spring-beans-2.5.xsd
           http://activemq.apache.org/camel/schema/spring http://activemq.apache.org/camel/
           schema/spring/camel-spring.xsd
       ">

    <camelContext xmlns="http://activemq.apache.org/camel/schema/spring"/>

        <bean id="myRecipientList" class="com.acme.foo.RouterBean"/>

    </beans>

```

then a route will be created consuming from the **foo** queue on the ActiveMQ component which when a message is received the message will be forwarded to the endpoints defined by the result of this method call - namely the **bar** and **whatnot** queues.

## How it works

The return value of the `@RecipientList` method is converted to either a `java.util.Collection` / `java.util.Iterator` or array of objects where each element is converted to an `Endpoint` or a `String`, or if you are only going to route to a single endpoint then just return either an `Endpoint` object or an object that can be converted to a `String`. So the following methods are all valid

```
@RecipientList
public String[] route(String body) { ... }

@RecipientList
public List<String> route(String body) { ... }

@RecipientList
public Endpoint route(String body) { ... }

@RecipientList
public Endpoint[] route(String body) { ... }

@RecipientList
public Collection<Endpoint> route(String body) { ... }

@RecipientList
public URI route(String body) { ... }

@RecipientList
public URI[] route(String body) { ... }
```

Then for each endpoint or URI the message is forwarded a separate copy to that endpoint.

You can then use whatever Java code you wish to figure out what endpoints to route to; for example you can use the Bean Binding annotations to inject parts of the message body or headers or use Expression values on the message.

## More Complex Example Using DSL

In this example we will use more complex Bean Binding, plus we will use a separate route to invoke the Recipient List

```
public class RouterBean2 {

    @RecipientList
    public String route(@Header("customerID") String custID String body) {
        if (custID == null) return null;
        return "activemq:Customers.Orders." + custID;
    }
}
```

```

public class MyRouteBuilder extends RouteBuilder {
    protected void configure() {
        from("activemq:Orders.Incoming").beanRef("myRouterBean", "route");
    }
}

```

Notice how we are injecting some headers or expressions and using them to determine the recipients. See the Bean Integration for more details.

## USING EXCHANGE PATTERN ANNOTATIONS

When working with POJO Producing or Spring Remoting you invoke methods which typically by default are InOut for Request Reply. That is there is an In message and an Out for the result. Typically invoking this operation will be synchronous, the caller will block until the server returns a result.

Camel has flexible Exchange Pattern support - so you can also support the Event Message pattern to use InOnly for asynchronous or one way operations. These are often called 'fire and forget' like sending a JMS message but not waiting for any response.

From 1.5 onwards Camel supports annotations for specifying the message exchange pattern on regular Java methods, classes or interfaces.

### Specifying InOnly methods

Typically the default InOut is what most folks want but you can customize to use InOnly using an annotation.

```

public interface Foo {
    Object someInOutMethod(String input);
    String anotherInOutMethod(Cheese input);

    @InOnly
    void someInOnlyMethod(Document input);
}

```

The above code shows three methods on an interface; the first two use the default InOut mechanism but the **someInOnlyMethod** uses the InOnly annotation to specify it as being a oneway method call.

### Class level annotations

You can also use class level annotations to default all methods in an interface to some pattern such as

```

@InOnly
public interface Foo {
    void someInOnlyMethod(Document input);
    void anotherInOnlyMethod(String input);
}

```

Annotations will also be detected on base classes or interfaces. So for example if you created a client side proxy for

```
public class MyFoo implements Foo {
    ...
}
```

Then the methods inherited from Foo would be InOnly.

## Overloading a class level annotation

You can overload a class level annotation on specific methods. A common use case for this is if you have a class or interface with many InOnly methods but you want to just annotate one or two methods as InOut

```
@InOnly
public interface Foo {
    void someInOnlyMethod(Document input);
    void anotherInOnlyMethod(String input);

    @InOut
    String someInOutMethod(String input);
}
```

In the above Foo interface the **someInOutMethod** will be InOut

## Using your own annotations

You might want to create your own annotations to represent a group of different bits of metadata; such as combining synchrony, concurrency and transaction behaviour.

So you could annotate your annotation with the @Pattern annotation to default the exchange pattern you wish to use.

For example lets say we want to create our own annotation called @MyAsyncService

```
@Retention(RetentionPolicy.RUNTIME)
@Target({ElementType.TYPE, ElementType.METHOD})

// lets add the message exchange pattern to it
@Pattern(ExchangePattern.InOnly)

// lets add some other annotations - maybe transaction behaviour?

public @interface MyAsyncService {
}
```

Now we can use this annotation and Camel will figure out the correct exchange pattern...

```
public interface Foo {
    void someInOnlyMethod(Document input);
    void anotherInOnlyMethod(String input);

    @MyAsyncService
}
```

```
String someInOutMethod(String input);  
}
```

When writing software these days, its important to try and decouple as much middleware code from your business logic as possible.

This provides a number of benefits...

- you can choose the right middleware solution for your deployment and switch at any time
- you don't have to spend a large amount of time learning the specifics of any particular technology, whether its JMS or JavaSpace or Hibernate or JPA or iBatis whatever

For example if you want to implement some kind of message passing, remoting, reliable load balancing or asynchronous processing in your application we recommend you use Camel annotations to bind your services and business logic to Camel Components which means you can then easily switch between things like

- in JVM messaging with SEDA
- using JMS via ActiveMQ or other JMS providers for reliable load balancing, grid or publish and subscribe
- for low volume, but easier administration since you're probably already using a database you could use
  - Hibernate or JPA to use an entity bean / table as a queue
  - iBatis to work with SQL
  - JDBC for raw SQL access
- use JavaSpace

## How to decouple from middleware APIs

The best approach when using remoting is to use Spring Remoting which can then use any messaging or remoting technology under the covers. When using Camel's implementation you can then use any of the Camel Components along with any of the Enterprise Integration Patterns.

Another approach is to bind Java beans to Camel endpoints via the Bean Integration. For example using POJO Consuming and POJO Producing you can avoid using any Camel APIs to decouple your code both from middleware APIs *and* Camel APIs! 😊

## VISUALISATION

Camel supports the visualisation of your Enterprise Integration Patterns using the GraphViz DOT files which can either be rendered directly via a suitable GraphViz tool or turned into HTML, PNG or SVG files via the Camel Maven Plugin.

Here is a typical example of the kind of thing we can generate



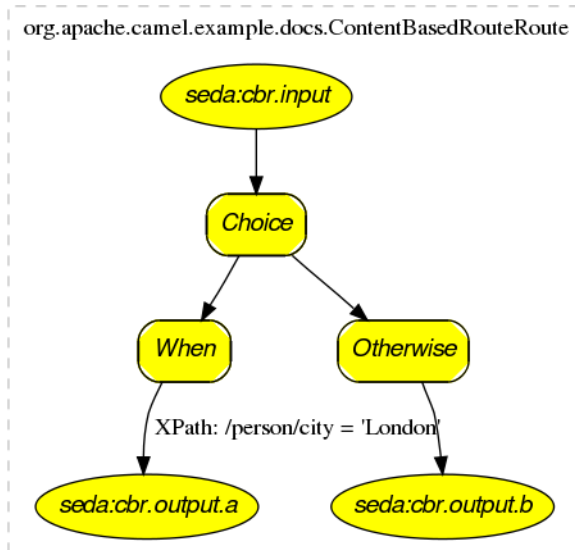

If you click on the actual generated html you will see that you can navigate from an EIP node to its pattern page, along with getting hover-over tool tips ec.

### How to generate

See Camel Dot Maven Goal or the other maven goals Camel Maven Plugin

### For OS X users

If you are using OS X then you can open the DOT file using graphviz which will then automatically re-render if it changes, so you end up with a real time graphical representation of the topic and queue hierarchies!

Also if you want to edit the layout a little before adding it to a wiki to distribute to your team, open the DOT file with OmniGraffle then just edit away 😊

## BUSINESS ACTIVITY MONITORING

The **Camel BAM** module provides a Business Activity Monitoring (BAM) framework for testing business processes across multiple message exchanges on different Endpoint instances.

For example if you have a simple system which you submit Purchase Orders into system A and then receive Invoices from system B, you might want to test that for a specific Purchase Order you receive a matching Invoice from system B within a specific time period.

## How Camel BAM Works

What Camel BAM does is use a Correlation Identifier on an input message to determine which *Process Instance* a message belongs to. The process instance is an entity bean which can maintain state for each *Activity* (where an activity typically maps to a single endpoint, such as the receipt of Purchase orders, or the receipt of Invoices).

You can then add rules which are fired when a message is received on any activity such as to set time expectations, or to perform real time reconciliation of values across activities etc.

## Simple Example

The following example shows how to perform some time based rules on a simple business process of 2 activities A and B (which maps to the Purchase Order and Invoice example above). If you want to experiment with this scenario you could edit the Test Case which defines the activities and rules, then tests that they work.

```
return new ProcessBuilder(jpaTemplate, transactionTemplate) {
    public void configure() throws Exception {

        // lets define some activities, correlating on an XPath on the message bodies
        ActivityBuilder a = activity("seda:a").name("a")
            .correlate(xpath("/hello/@id"));

        ActivityBuilder b = activity("seda:b").name("b")
            .correlate(xpath("/hello/@id"));

        // now lets add some rules
        b.starts().after(a.completes())
            .expectWithin(seconds(1))
            .errorIfOver(seconds(errorTimeout)).to("mock:overdue");
    }
};
```

As you can see in the above example, we define two activities first, then we define rules on when we expect the activities on an individual process instance to complete by along with the time at which we should assume there is an error. The `ProcessBuilder` is-a `RouteBuilder` and can be added to any `CamelContext`

## Complete Example

For a complete example please see the [BAM Example](#) which is part of the standard Camel Examples

## Use Cases

In the world of finance a common requirement is tracking financial trades. Often a trader will submit a *Front Office Trade* which then flows through the *Middle Office* and *Back Office* through various systems to settle the trade so that money is exchanged. You may wish to add

tests that front and back office trades match up within a time period; if they don't match or a back office trade does not arrive within a required amount of time, you might want to fire off an alarm.

## EXTRACT TRANSFORM LOAD (ETL)

The ETL (Extract, Transform, Load) is a mechanism for loading data into systems or databases using some kind of Data Format from a variety of sources; often files then using Pipes and Filters, Message Translator and possible other Enterprise Integration Patterns.

So you could query data from various Camel Components such as File, HTTP or JPA, perform multiple patterns such as Splitter or Message Translator then send the messages to some other Component.

To show how this all fits together, try the ETL Example

## MOCK COMPONENT

Testing of distributed and asynchronous processing is notoriously difficult. The Mock, Test and DataSet endpoints work great with the Camel Testing Framework to simplify your unit and integration testing using Enterprise Integration Patterns and Camel's large range of Components together with the powerful Bean Integration.

The Mock component provides a powerful declarative testing mechanism which is similar to jMock in that it allows declarative expectations to be created on any Mock endpoint before a test begins. Then the test is ran which typically fires messages to one or more endpoints and finally the expectations can be asserted in a test case to ensure the system worked as expected.

This allows you to test various things like:

- the correct number of messages are received on each endpoint
- that the correct payloads are received, in the right order
- that messages arrive on an endpoint in order, using some Expression to create an order testing function
- that messages arrive match some kind of Predicate such as that specific headers have certain values, or that parts of the messages match some predicate such as by evaluating an XPath or XQuery Expression

**Note** that there is also the Test endpoint which is-a Mock endpoint but which also uses a second endpoint to provide the list of expected message bodies and automatically sets up the Mock endpoint assertions. i.e. its a Mock endpoint which automatically sets up its assertions from some sample messages in a File or database for example.

### URI format

```
mock:someName?options
```

Where **someName** can be any string to uniquely identify the endpoint

## Options

Option	Default	Description
reportGroup	null	A size to use a throughput logger for reporting

## Simple Example

Here's a simple example of MockEndpoint in use. First the endpoint is resolved on the context. Then we set an expectation, then after the test has run we assert our expectations are met.

```
MockEndpoint resultEndpoint = context.resolveEndpoint("mock:foo", MockEndpoint.class);
resultEndpoint.expectedMessageCount(2);

// send some messages
...

// now lets assert that the mock:foo endpoint received 2 messages
resultEndpoint.assertIsSatisfied();
```

You typically always call the `assertIsSatisfied()` method to test that the expectations were met after running a test.

Camel will by default wait 20 seconds when the `assertIsSatisfied()` is invoked. This can be configured by setting the `setResultWaitTime(millis)` method.

## Setting expectations

You can see from the javadoc of MockEndpoint the various helper methods you can use to set expectations. The main methods available are as follows:

Method	Description
<code>expectedMessageCount(int)</code>	to define the expected message count on the endpoint
<code>expectedMinimumMessageCount(int)</code>	to define the minimum number of expected messages on the endpoint
<code>expectedBodiesReceived(...)</code>	to define the expected bodies that should be received (in order)
<code>expectedHeaderReceived(...)</code>	to define the expected header that should be received
<code>expectsAscending(Expression)</code>	to add an expectation that messages are received in order using the given Expression to compare messages

<code>expectsDescending(Expression)</code>	to add an expectation that messages are received in order using the given Expression to compare messages
<code>expectsNoDuplicates(Expression)</code>	to add an expectation that no duplicate messages are received; using an Expression to calculate a unique identifier for each message. This could be something like the <code>JMSMessageID</code> if using JMS, or some unique reference number within the message.

Here's another example:

```
resultEndpoint.expectedBodiesReceived("firstMessageBody", "secondMessageBody",
"thirdMessageBody");
```

## Adding expectations to specific messages

In addition you can use the `message(int messageIndex)` method to add assertions about a specific message that is received.

For example to add expectations of the headers or body of the first message (using zero based indexing like `java.util.List`), you can use this code

```
resultEndpoint.message(0).header("foo").isEqualTo("bar");
```

There are some examples of the Mock endpoint in use in the camel-core processor tests.

## A Spring Example

First here's the `spring.xml` file

```
<camelContext xmlns="http://camel.apache.org/schema/spring">
  <route>
    <from uri="file:src/test/data?noop=true" />
    <filter>
      <xpath>/person/city = 'London'</xpath>
      <to uri="mock:matched" />
    </filter>
  </route>
</camelContext>

<bean id="myBean" class="org.apache.camel.spring.mock.MyAssertions" scope="singleton" />
```

As you can see it defines a simple routing rule which consumes messages from the local `src/test/data` directory. The **noop** flag just means not to delete or move the file after its been processed.

Also note we instantiate a bean called **myBean**, here is the source of the `MyAssertions` bean.

```

public class MyAssertions implements InitializingBean {
    @EndpointInject(uri = "mock:matched")
    private MockEndpoint matched;

    @EndpointInject(uri = "mock:notMatched")
    private MockEndpoint notMatched;

    public void afterPropertiesSet() throws Exception {
        // lets add some expectations
        matched.expectedMessageCount(1);
        notMatched.expectedMessageCount(0);
    }

    public void assertEndpointsValid() throws Exception {
        // now lets perform some assertions that the test worked as we expect
        Assert.assertNotNull("Should have a matched endpoint", matched);
        Assert.assertNotNull("Should have a notMatched endpoint", notMatched);
        MockEndpoint.assertIsSatisfied(matched, notMatched);
    }
}

```

The bean is injected with a bunch of Mock endpoints using the `@EndpointInject` annotation, it then sets a bunch of expectations on startup (using Spring's `InitializingBean` interface and `afterPropertiesSet()` method) before the `CamelContext` starts up.

Then in our test case (which could be JUnit or TestNG) we lookup **myBean** in Spring (or have it injected into our test) and then invoke the **assertEndpointsValid()** method on it to verify that the mock endpoints have their assertions met. You could then inspect the message exchanges that were delivered to any of the endpoints using the `getReceivedExchanges()` method on the Mock endpoint and perform further assertions or debug logging.

Here is the actual JUnit test case we use.

## See Also

- [Configuring Camel](#)
- [Component](#)
- [Endpoint](#)
- [Getting Started](#)
- [Spring Testing](#)

## TESTING

Testing is a crucial activity in any piece of software development or integration. Typically Camel Riders use various different technologies wired together in a variety of patterns with different expression languages together with different forms of Bean Integration and Dependency

Injection so its very easy for things to go wrong! 😊. Testing is the crucial weapon to ensure that things work as you would expect.

Camel is a Java library so you can easily wire up tests in whatever unit testing framework you use (JUnit 3.x, 4.x or TestNG). However the Camel project has tried to make the testing of Camel as easy and powerful as possible so we have introduced the following features.

## Testing mechanisms

The following mechanisms are supported

Name	Description
Camel Test	is a library letting you easily create Camel test cases using a single Java class for all your configuration and routing without using Spring or Guice for Dependency Injection which does not require an in depth knowledge of Spring+SpringTest or Guice
Spring Testing	uses Spring Test together with either XML or Java Config to dependency inject your test classes
Guice	uses Guice to dependency inject your test classes

In all approaches the test classes look pretty much the same in that they all reuse the Camel binding and injection annotations.

## Camel Test Example

Here is the Camel Test example.

```
public class FilterTest extends CamelTestSupport {

    @EndpointInject(uri = "mock:result")
    protected MockEndpoint resultEndpoint;

    @Produce(uri = "direct:start")
    protected ProducerTemplate template;

    public void testSendMatchingMessage() throws Exception {
        String expectedBody = "<matched/>";

        resultEndpoint.expectedBodiesReceived(expectedBody);

        template.sendBodyAndHeader(expectedBody, "foo", "bar");

        resultEndpoint.assertIsSatisfied();
    }

    public void testSendNotMatchingMessage() throws Exception {
        resultEndpoint.expectedMessageCount(0);

        template.sendBodyAndHeader("<notMatched/>", "foo", "notMatchedHeaderValue");

        resultEndpoint.assertIsSatisfied();
    }
}
```

```

@Override
protected RouteBuilder createRouteBuilder() {
    return new RouteBuilder() {
        public void configure() {

from("direct:start").filter(header("foo").isEqualTo("bar")).to("mock:result");

        }
    };
}
}

```

Notice how it derives from the Camel helper class **CamelTestSupport** but has no Spring or Guice dependency injection configuration but instead overrides the **createRouteBuilder()** method.

## Spring Test with XML Config Example

Here is the Spring Testing example using XML Config.

```

@ContextConfiguration
public class FilterTest extends AbstractJUnit38SpringContextTests {

    @EndpointInject(uri = "mock:result")
    protected MockEndpoint resultEndpoint;

    @Produce(uri = "direct:start")
    protected ProducerTemplate template;

    @DirtiesContext
    public void testSendMatchingMessage() throws Exception {
        String expectedBody = "<matched/>";

        resultEndpoint.expectedBodiesReceived(expectedBody);

        template.sendBodyAndHeader(expectedBody, "foo", "bar");

        resultEndpoint.assertIsSatisfied();
    }

    @DirtiesContext
    public void testSendNotMatchingMessage() throws Exception {
        resultEndpoint.expectedMessageCount(0);

        template.sendBodyAndHeader("<notMatched/>", "foo", "notMatchedHeaderValue");

        resultEndpoint.assertIsSatisfied();
    }
}

```

Notice that we use **@DirtiesContext** on the test methods to force Spring Testing to automatically reload the CamelContext after each test method - this ensures that the tests



don't clash with each other (e.g. one test method sending to an endpoint that is then reused in another test method).

Also notice the use of **@ContextConfiguration** to indicate that by default we should look for the FilterTest-context.xml on the classpath to configure the test case which looks like this

```
<beans xmlns="http://www.springframework.org/schema/beans"
       xmlns:xsi="http://www.w3.org/2001/XMLSchema-instance"
       xmlns:context="http://www.springframework.org/schema/context"
       xsi:schemaLocation="
http://www.springframework.org/schema/beans http://www.springframework.org/
schema/beans/spring-beans-2.5.xsd
http://camel.apache.org/schema/spring http://camel.apache.org/schema/spring/
camel-spring.xsd
">

  <camelContext xmlns="http://camel.apache.org/schema/spring">
    <route>
      <from uri="direct:start"/>
      <filter>
        <xpath>$foo = 'bar'</xpath>
        <to uri="mock:result"/>
      </filter>
    </route>
  </camelContext>

</beans>
```

## Spring Test with Java Config Example

Here is the Spring Testing example using Java Config. For more information see [Spring Java Config](#).

```
@ContextConfiguration(
    locations =
"org.apache.camel.spring.javaconfig.patterns.FilterTest$ContextConfig",
    loader = JavaConfigContextLoader.class)
public class FilterTest extends AbstractJUnit38SpringContextTests {

    @EndpointInject(uri = "mock:result")
    protected MockEndpoint resultEndpoint;

    @Produce(uri = "direct:start")
    protected ProducerTemplate template;

    @DirtiesContext
    public void testSendMatchingMessage() throws Exception {
        String expectedBody = "<matched/>";

        resultEndpoint.expectedBodiesReceived(expectedBody);

        template.sendBodyAndHeader(expectedBody, "foo", "bar");
    }
}
```

```

        resultEndpoint.assertIsSatisfied();
    }

    @DirtiesContext
    public void testSendNotMatchingMessage() throws Exception {
        resultEndpoint.expectedMessageCount(0);

        template.sendBodyAndHeader("<notMatched/>", "foo", "notMatchedHeaderValue");

        resultEndpoint.assertIsSatisfied();
    }

    @Configuration
    public static class ContextConfig extends SingleRouteCamelConfiguration {
        @Bean
        public RouteBuilder route() {
            return new RouteBuilder() {
                public void configure() {
                    from("direct:start").filter(header("foo").isEqualTo("bar")).to("mock:result");
                }
            };
        }
    }
}

```

This is similar to the XML Config example above except that there is no XML file and instead the nested **ContextConfig** class does all of the configuration; so your entire test case is contained in a single Java class. We currently have to reference by class name this class in the **@ContextConfiguration** which is a bit ugly. Please vote for SJC-238 to address this and make Spring Test work more cleanly with Spring JavaConfig.

Its totally optional but for the ContextConfig implementation we derive from **SingleRouteCamelConfiguration** which is a helper Spring Java Config class which will configure the CamelContext for us and then register the RouteBuilder we create.

## Testing endpoints

Camel provides a number of endpoints which can make testing easier.

Name	Description
DataSet	For load & soak testing this endpoint provides a way to create huge numbers of messages for sending to Components and asserting that they are consumed correctly
Mock	For testing routes and mediation rules using mocks and allowing assertions to be added to an endpoint
Test	Creates a Mock endpoint which expects to receive all the message bodies that could be polled from the given underlying endpoint

The main endpoint is the Mock endpoint which allows expectations to be added to different endpoints; you can then run your tests and assert that your expectations are met at the end.

### Stubbing out physical transport technologies

If you wish to test out a route but want to avoid actually using a real physical transport (for example to unit test a transformation route rather than performing a full integration test) then the following endpoints can be useful.

Name	Description
Direct	Direct invocation of the consumer from the producer so that single threaded (non-SEDA) in VM invocation is performed which can be useful to mock out physical transports
SEDA	Delivers messages asynchronously to consumers via a <code>java.util.concurrent.BlockingQueue</code> which is good for testing asynchronous transports

## CAMEL TEST

As a simple alternative to using Spring Testing or Guice the **camel-test** module was introduced into the Camel 2.0 trunk so you can perform powerful Testing of your Enterprise Integration Patterns easily.

### Adding to your pom.xml

To get started using Camel Test you will need to add an entry to your pom.xml

```
<dependency>
  <groupId>org.apache.camel</groupId>
  <artifactId>camel-test</artifactId>
  <version>${camel-version}</version>
  <scope>test</scope>
</dependency>
```

You might also want to add commons-logging and log4j to ensure nice logging messages (and maybe adding a `log4j.properties` file into your `src/test/resources` directory).

```
<dependency>
  <groupId>commons-logging</groupId>
  <artifactId>commons-logging</artifactId>
  <scope>test</scope>
</dependency>
<dependency>
  <groupId>log4j</groupId>
  <artifactId>log4j</artifactId>
  <scope>test</scope>
</dependency>
```

## Writing your test

You firstly need to derive from the class **CamelTestSupport** and typically you will need to override the **createRouteBuilder()** method to create routes to be tested.

Here is an example.

```
public class FilterTest extends CamelTestSupport {

    @EndpointInject(uri = "mock:result")
    protected MockEndpoint resultEndpoint;

    @Produce(uri = "direct:start")
    protected ProducerTemplate template;

    public void testSendMatchingMessage() throws Exception {
        String expectedBody = "<matched/>";

        resultEndpoint.expectedBodiesReceived(expectedBody);

        template.sendBodyAndHeader(expectedBody, "foo", "bar");

        resultEndpoint.assertIsSatisfied();
    }

    public void testSendNotMatchingMessage() throws Exception {
        resultEndpoint.expectedMessageCount(0);

        template.sendBodyAndHeader("<notMatched/>", "foo", "notMatchedHeaderValue");

        resultEndpoint.assertIsSatisfied();
    }

    @Override
    protected RouteBuilder createRouteBuilder() {
        return new RouteBuilder() {
            public void configure() {

                from("direct:start").filter(header("foo").isEqualTo("bar")).to("mock:result");
            }
        };
    }
}
```

Notice how you can use the various Camel binding and injection annotations to inject individual Endpoint objects - particularly the Mock endpoints which are very useful for Testing. Also you can inject producer objects such as ProducerTemplate or some application code interface for sending messages or invoking services.

## JNDI

Camel uses a Registry to allow you to configure Component or Endpoint instances or Beans used in your routes. If you are not using Spring or [OSGi] then JNDI is used as the default registry implementation.

So you will also need to create a **jndi.properties** file in your **src/test/resources** directory so that there is a default registry available to initialise the CamelContext.

Here is an example jndi.properties file

```
java.naming.factory.initial = org.apache.camel.util.jndi.CamelInitialContextFactory
```

## See Also

- Testing
- Mock

## SPRING TESTING

Testing is a crucial part of any development or integration work. The Spring Framework offers a number of features that makes it easy to test while using Spring for Inversion of Control which works with JUnit 3.x, JUnit 4.x or TestNG.

We can reuse Spring for IoC and the Camel Mock and Test endpoints to create sophisticated integration tests that are easy to run and debug inside your IDE.

For example here is a simple unit test

```
import org.apache.camel.CamelContext;
import org.apache.camel.component.mock.MockEndpoint;
import org.springframework.beans.factory.annotation.Autowired;
import org.springframework.test.context.ContextConfiguration;
import org.springframework.test.context.junit38.AbstractJUnit38SpringContextTests;

@ContextConfiguration
public class MyCamelTest extends AbstractJUnit38SpringContextTests {

    @Autowired
    protected CamelContext camelContext;

    public void testMocksAreValid() throws Exception {
        MockEndpoint.assertIsSatisfied(camelContext);
    }
}
```

This test will load a Spring XML configuration file called **MyCamelTest-context.xml** from the classpath in the same package structure as the MyCamelTest class and initialize it along with any Camel routes we define inside it, then inject the CamelContext instance into our test case.

For instance, like this maven folder layout:

```
src/main/java/com/mycompany/MyCamelTest.class
src/main/resources/com/mycompany/MyCamelTest-context.xml
```

You can overload the method `createApplicationContext` to provide the Spring `ApplicationContext` that isn't following the above default. For instance:

```
protected AbstractXmlApplicationContext createApplicationContext() {
    return new ClassPathXmlApplicationContext("/config/MySpringConfig.xml");
}
```

Then the test method will then run which invokes the `MockEndpoint.assertIsSatisfied(camelContext)` method which asserts that all of the Mock and Test endpoints have their expectations met.

```
xml}
```

## Spring Test with Java Config Example

You can completely avoid using an XML configuration file by using Spring Java Config.

Here is an example using Java Config.

```
@ContextConfiguration(
    locations =
    "org.apache.camel.spring.javaconfig.patterns.FilterTest$ContextConfig",
    loader = JavaConfigContextLoader.class)
public class FilterTest extends AbstractJUnit38SpringContextTests {

    @EndpointInject(uri = "mock:result")
    protected MockEndpoint resultEndpoint;

    @Produce(uri = "direct:start")
    protected ProducerTemplate template;

    @DirtiesContext
    public void testSendMatchingMessage() throws Exception {
        String expectedBody = "<matched/>";

        resultEndpoint.expectedBodiesReceived(expectedBody);

        template.sendBodyAndHeader(expectedBody, "foo", "bar");

        resultEndpoint.assertIsSatisfied();
    }

    @DirtiesContext
    public void testSendNotMatchingMessage() throws Exception {
        resultEndpoint.expectedMessageCount(0);

        template.sendBodyAndHeader("<notMatched/>", "foo", "notMatchedHeaderValue");

        resultEndpoint.assertIsSatisfied();
    }

    @Configuration
    public static class ContextConfig extends SingleRouteCamelConfiguration {
        @Bean
        public RouteBuilder route() {
            return new RouteBuilder() {
                public void configure() {
```

```

from("direct:start").filter(header("foo").isEqualTo("bar")).to("mock:result");
    }
};
}
}
}
}

```

This is similar to the XML Config example above except that there is no XML file and instead the nested **ContextConfig** class does all of the configuration; so your entire test case is contained in a single Java class. We currently have to reference by class name this class in the **@ContextConfiguration** which is a bit ugly. Please vote for [SJC-238](#) to address this and make Spring Test work more cleanly with Spring JavaConfig.

### Adding more Mock expectations

If you wish to programmatically add any new assertions to your test you can easily do so with the following. Notice how we use **@EndpointInject** to inject a Camel endpoint into our code then the Mock API to add an expectation on a specific message.

```

@ContextConfiguration
public class MyCamelTest extends AbstractJUnit38SpringContextTests {

    @Autowired
    protected CamelContext camelContext;

    @EndpointInject(uri = "mock:foo")
    protected MockEndpoint foo;

    public void testMocksAreValid() throws Exception {
        // lets add more expectations
        foo.message(0).header("bar").isEqualTo("ABC");

        MockEndpoint.assertIsSatisfied(camelContext);
    }
}

```

### Further processing the received messages

Sometimes once a Mock endpoint has received some messages you want to then process them further to add further assertions that your test case worked as you expect.

So you can then process the received message exchanges if you like...

```

@ContextConfiguration
public class MyCamelTest extends AbstractJUnit38SpringContextTests {

    @Autowired
    protected CamelContext camelContext;

    @EndpointInject(uri = "mock:foo")
    protected MockEndpoint foo;

```

```

public void testMocksAreValid() throws Exception {
    // lets add more expectations...

    MockEndpoint.assertIsSatisfied(camelContext);

    // now lets do some further assertions
    List<Exchange> list = foo.getReceivedExchanges();
    for (Exchange exchange : list) {
        Message in = exchange.getIn();
        ...
    }
}
}
}

```

## Sending and receiving messages

It might be that the Enterprise Integration Patterns you have defined in either Spring XML or using the Java DSL do all of the sending and receiving and you might just work with the Mock endpoints as described above. However sometimes in a test case its useful to explicitly send or receive messages directly.

To send or receive messages you should use the Bean Integration mechanism. For example to send messages inject a `ProducerTemplate` using the `@EndpointInject` annotation then call the various send methods on this object to send a message to an endpoint. To consume messages use the `@MessageDriven` annotation on a method to have the method invoked when a message is received.

```

public class Foo {
    @EndpointInject(uri="activemq:foo.bar")
    ProducerTemplate producer;

    public void doSomething() {
        // lets send a message!
        producer.sendBody("<hello>world!</hello>");
    }

    // lets consume messages from the 'cheese' queue
    @MessageDriven(uri="activemq:cheese")
    public void onCheese(String name) {
        ...
    }
}
}

```

## See Also

- a real example test case using Mock and Spring along with its Spring XML
- Bean Integration
- Mock endpoint
- Test endpoint



## CAMEL GUICE

As of 1.5 we now have support for Google Guice as a dependency injection framework. To use it just be dependent on **camel-guice.jar** which also depends on the following jars.

### Dependency Injecting Camel with Guice

The `GuiceCamelContext` is designed to work nicely inside Guice. You then need to bind it using some Guice Module.

The `camel-guice` library comes with a number of reusable Guice Modules you can use if you wish - or you can bind the `GuiceCamelContext` yourself in your own module.

- `CamelModule` is the base module which binds the `GuiceCamelContext` but leaves it up to you to bind the `RouteBuilder` instances
- `CamelModuleWithRouteTypes` extends `CamelModule` so that in the constructor of the module you specify the `RouteBuilder` classes or instances to use
- `CamelModuleWithMatchingRoutes` extends `CamelModule` so that all bound `RouteBuilder` instances will be injected into the `CamelContext` or you can supply an optional `Matcher` to find `RouteBuilder` instances matching some kind of predicate.

So you can specify the exact `RouteBuilder` instances you want

```
Injector injector = Guice.createInjector(new
CamelModuleWithRouteTypes(MyRouteBuilder.class, AnotherRouteBuilder.class));
// if required you can lookup the CamelContext
CamelContext camelContext = injector.getInstance(CamelContext.class);
```

Or inject them all

```
Injector injector = Guice.createInjector(new CamelModuleWithRouteTypes());
// if required you can lookup the CamelContext
CamelContext camelContext = injector.getInstance(CamelContext.class);
```

You can then use Guice in the usual way to inject the route instances or any other dependent objects.

### Bootstrapping with JNDI

A common pattern used in J2EE is to bootstrap your application or root objects by looking them up in JNDI. This has long been the approach when working with JMS for example - looking up the `JMSConnectionFactory` in JNDI for example.

You can follow a similar pattern with Guice using the `GuiceyFruit JNDI Provider` which lets you bootstrap Guice from a **`jndi.properties`** file which can include the Guice Modules to create along with environment specific properties you can inject into your modules and objects.

### Configuring Component, Endpoint or RouteBuilder instances

You can use Guice to dependency inject whatever objects you need to create, be it an `Endpoint`, `Component`, `RouteBuilder` or arbitrary bean used within a route.

The easiest way to do this is to create your own Guice Module class which extends one of the above module classes and add a provider method for each object you wish to create. A provider method is annotated with **@Provides** as follows

```
public class MyModule extends CamelModuleWithMatchingRoutes {

    @Provides
    @JndiBind("jms")
    JmsComponent jms(@Named("activemq.brokerURL") String brokerUrl) {
        return JmsComponent.jmsComponent(new ActiveMQConnectionFactory(brokerUrl));
    }
}
```

You can optionally annotate the method with **@JndiBind** to bind the object to JNDI at some name if the object is a component, endpoint or bean you wish to refer to by name in your routes.

You can inject any environment specific properties (such as URLs, machine names, usernames/passwords and so forth) from the jndi.properties file easily using the **@Named** annotation as shown above. This allows most of your configuration to be in Java code which is typesafe and easily refactorable - then leaving some properties to be environment specific (the jndi.properties file) which you can then change based on development, testing, production etc.

## Creating multiple RouteBuilder instances per type

It is sometimes useful to create multiple instances of a particular RouteBuilder with different configurations.

To do this just create multiple provider methods for each configuration; or create a single provider method that returns a collection of RouteBuilder instances.

For example

```
import org.apache.camel.guice.CamelModuleWithMatchingRoutes;
import com.google.common.collect.Lists;

public class MyModule extends CamelModuleWithMatchingRoutes {

    @Provides
    @JndiBind("foo")
    Collection<RouteBuilder> foo(@Named("fooUrl") String fooUrl) {
        return Lists.newArrayList(new MyRouteBuilder(fooUrl), new
MyRouteBuilder("activemq:CheeseQueue"));
    }
}
```

## See Also

- there are a number of Examples you can look at to see Guice and Camel being used such as Guice JMS Example
- Guice Maven Plugin for running your Guice based routes via Maven

## TEMPLATING

When you are testing distributed systems its a very common requirement to have to stub out certain external systems with some stub so that you can test other parts of the system until a specific system is available or written etc.

A great way to do this is using some kind of Template system to generate responses to requests generating a dynamic message using a mostly-static body.

There are a number of templating components you could use

- StringTemplate
- Velocity
- XQuery
- XSLT

### Example

Here's a simple example showing how we can respond to InOut requests on the **My.Queue** queue on ActiveMQ with a template generated response. The reply would be sent back to the JMSReplyTo Destination.

```
from("activemq:My.Queue").
to("velocity:com/acme/MyResponse.vm");
```

If you want to use InOnly and consume the message and send it to another destination you could use

```
from("activemq:My.Queue").
to("velocity:com/acme/MyResponse.vm").
to("activemq:Another.Queue");
```

### See Also

- Mock for details of mock endpoint testing (as opposed to template based stubs).

## DATABASE

Camel can work with databases in a number of different ways. This document tries to outline the most common approaches.

### Database endpoints

Camel provides a number of different endpoints for working with databases

- JPA for working with hibernate, openjpa or toplink. When consuming from the endpoints entity beans are read (and deleted/updated to mark as processed) then when producing to the endpoints they are written to the database (via insert/update).
- iBatis similar to the above but using Apache iBATIS

- JDBC similar though using explicit SQL

## Database pattern implementations

Various patterns can work with databases as follows

- Idempotent Consumer
- Aggregator
- BAM for business activity monitoring

## PARALLEL PROCESSING AND ORDERING

It is a common requirement to want to use parallel processing of messages for throughput and load balancing, while at the same time process certain kinds of messages in order.

### How to achieve parallel processing

You can send messages to a number of Camel Components to achieve parallel processing and load balancing such as

- SEDA for in-JVM load balancing across a thread pool
- ActiveMQ or JMS for distributed load balancing and parallel processing
- JPA for using the database as a poor mans message broker

When processing messages concurrently, you should consider ordering and concurrency issues. These are described below

### Concurrency issues

Note that there is no concurrency or locking issue when using ActiveMQ, JMS or SEDA by design; they are designed for highly concurrent use. However there are possible concurrency issues in the Processor of the messages i.e. what the processor does with the message?

For example if a processor of a message transfers money from one account to another account; you probably want to use a database with pessimistic locking to ensure that operation takes place atomically.

### Ordering issues

As soon as you send multiple messages to different threads or processes you will end up with an unknown ordering across the entire message stream as each thread is going to process messages concurrently.

For many use cases the order of messages is not too important. However for some applications this can be crucial. e.g. if a customer submits a purchase order version 1, then amends it and sends version 2; you don't want to process the first version last (so that you

lose the update). Your Processor might be clever enough to ignore old messages. If not you need to preserve order.

## Recommendations

This topic is large and diverse with lots of different requirements; but from a high level here are our recommendations on parallel processing, ordering and concurrency

- for distributed locking, use a database by default, they are very good at it 😊
- to preserve ordering across a JMS queue consider using Exclusive Consumers in the ActiveMQ component
- even better are Message Groups which allows you to preserve ordering across messages while still offering parallelisation via the **JMSXGroupID** header to determine what can be parallelized
- if you receive messages out of order you could use the Resequencer to put them back together again

A good rule of thumb to help reduce ordering problems is to make sure each single can be processed as an atomic unit in parallel (either without concurrency issues or using say, database locking); or if it can't, use a Message Group to relate the messages together which need to be processed in order by a single thread.

## Using Message Groups with Camel

To use a Message Group with Camel you just need to add a header to the output JMS message based on some kind of Correlation Identifier to correlate messages which should be processed in order by a single thread - so that things which don't correlate together can be processed concurrently.

For example the following code shows how to create a message group using an XPath expression taking an invoice's product code as the Correlation Identifier

```
from("activemq:a").setHeader("JMSXGroupID", xpath("/invoice/  
productCode")).to("activemq:b");
```

You can of course use the Xml Configuration if you prefer

# ASYNCHRONOUS PROCESSING

## Overview

Camel supports a more complex asynchronous processing model. The asynchronous processors implement the AsyncProcessor interface which is derived from the more synchronous Processor interface. There are advantages and disadvantages when using asynchronous processing when compared to using the standard synchronous processing model.

Advantages:

- Processing routes that are composed fully of asynchronous processors do not use up threads waiting for processors to complete on blocking calls. This can increase the scalability of your system by reducing the number of threads needed to process the same workload.
- Processing routes can be broken up into SEDA processing stages where different thread pools can process the different stages. This means that your routes can be processed concurrently.

Disadvantages:

- Implementing asynchronous processors is more complex than implementing the synchronous versions.

## When to Use

We recommend that processors and components be implemented the more simple synchronous APIs unless you identify a performance or scalability requirement that dictates otherwise. A Processor whose `process()` method blocks for a long time would be good candidates for being converted into an asynchronous processor.

## Interface Details

```
public interface AsyncProcessor extends Processor {
    boolean process(Exchange exchange, AsyncCallback callback);
}
```

The `AsyncProcessor` defines a single `process()` method which is very similar to its synchronous `Processor.process()` brethren. Here are the differences:

- A non-null `AsyncCallback` **MUST** be supplied which will be notified when the exchange processing is completed.
- It **MUST** not throw any exceptions that occurred while processing the exchange. Any such exceptions must be stored on the exchange's `Exception` property.
- It **MUST** know if it will complete the processing synchronously or asynchronously. The method will return `true` if it does complete synchronously, otherwise it returns `false`.
- When the processor has completed processing the exchange, it must call the `callback.done(boolean sync)` method. The `sync` parameter **MUST** match the value returned by the `process()` method.

## Implementing Processors that Use the AsyncProcessor API

All processors, even synchronous processors that do not implement the `AsyncProcessor` interface, can be coerced to implement the `AsyncProcessor` interface. This is usually done when you are implementing a Camel component consumer that supports asynchronous completion of the exchanges that it is pushing through the Camel routes. Consumers are provided a

Processor object when created. All Processor object can be coerced to a AsyncProcessor using the following API:

```
Processor processor = ...
AsyncProcessor asyncProcessor = AsyncProcessorTypeConverter.convert(processor);
```

For a route to be fully asynchronous and reap the benefits to lower Thread usage, it must start with the consumer implementation making use of the asynchronous processing API. If it called the synchronous process() method instead, the consumer's thread would be forced to be blocked and in use for the duration that it takes to process the exchange.

It is important to take note that just because you call the asynchronous API, it does not mean that the processing will take place asynchronously. It only allows the possibility that it can be done without tying up the caller's thread. If the processing happens asynchronously is dependent on the configuration of the Camel route.

Normally, the the process call is passed in an inline inner AsyncCallback class instance which can reference the exchange object that was declared final. This allows it to finish up any post processing that is needed when the called processor is done processing the exchange. See below for an example.

```
final Exchange exchange = ...
AsyncProcessor asyncProcessor = ...
asyncProcessor.process(exchange, new AsyncCallback() {
    public void done(boolean sync) {

        if (exchange.isFailed()) {
            ... // do failure processing.. perhaps rollback etc.
        } else {
            ... // processing completed successfully, finish up
                // perhaps commit etc.
        }
    }
});
```

## Asynchronous Route Sequence Scenarios

Now that we have understood the interface contract of the AsyncProcessor, and have seen how to make use of it when calling processors, lets looks a what the thread model/sequence scenarios will look like for some sample routes.

The Jetty component's consumers support async processing by using continuations. Suffice to say it can take a http request and pass it to a camel route for async processing. If the processing is indeed async, it uses Jetty continuation so that the http request is 'parked' and the thread is released. Once the camel route finishes processing the request, the jetty component uses the AsyncCallback to tell Jetty to 'un-park' the request. Jetty un-parks the request, the http response returned using the result of the exchange processing.

Notice that the jetty continuations feature is only used "If the processing is indeed async". This is why AsyncProcessor.process() implementations MUST accurately report if request is completed synchronously or not.

The `jhc` component's producer allows you to make HTTP requests and implement the `AsyncProcessor` interface. A route that uses both the `jetty` asynchronous consumer and the `jhc` asynchronous producer will be a fully asynchronous route and has some nice attributes that can be seen if we take a look at a sequence diagram of the processing route. For the route:

```
from("jetty:http://localhost:8080/service").to("jhc:http://localhost/service-impl");
```

The sequence diagram would look something like this:

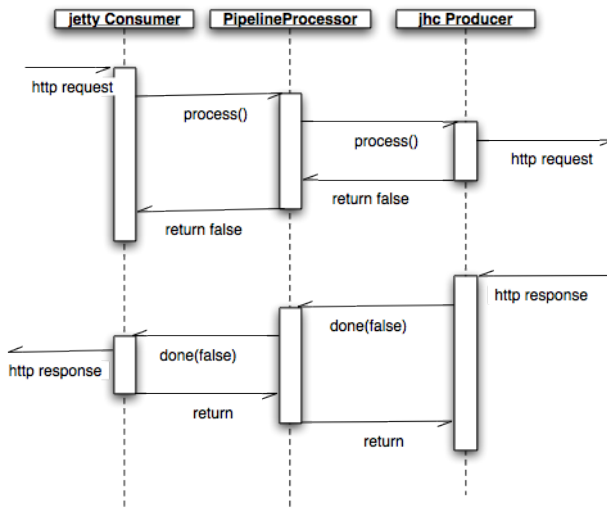

The diagram simplifies things by making it look like processors implement the `AsyncCallback` interface when in reality the `AsyncCallback` interfaces are inline inner classes, but it illustrates the processing flow and shows how 2 separate threads are used to complete the processing of the original http request. The first thread is synchronous up until processing hits the `jhc` producer which issues the http request. It then reports that the exchange processing will complete async since it will use a NIO to complete getting the response back. Once the `jhc` component has received a full response it uses `AsyncCallback.done()` method to notify the caller. These callback notifications continue up until it reaches the original `jetty` consumer which then un-parks the http request and completes it by providing the response.

## Mixing Synchronous and Asynchronous Processors

It is totally possible and reasonable to mix the use of synchronous and asynchronous processors/components. The pipeline processor is the backbone of a Camel processing route. It glues all the processing steps together. It is implemented as an `AsyncProcessor` and supports interleaving synchronous and asynchronous processors as the processing steps in the pipeline.

Lets say we have 2 custom processors, `MyValidator` and `MyTransformation`, both of which are synchronous processors. Lets say we want to load file from the `data/in` directory validate them with the `MyValidator()` processor, Transform them into JPA java objects using `MyTransformation` and then insert them into the database using the JPA component. Lets say



that the transformation process takes quite a bit of time and we want to allocate 20 threads to do parallel transformations of the input files. The solution is to make use of the thread processor. The thread is AsyncProcessor that forces subsequent processing in asynchronous thread from a thread pool.

The route might look like:

```
from("file:data/in").process(new MyValidator()).thread(20).process(new MyTransformation()).to("jpa:PurchaseOrder");
```

The sequence diagram would look something like this:

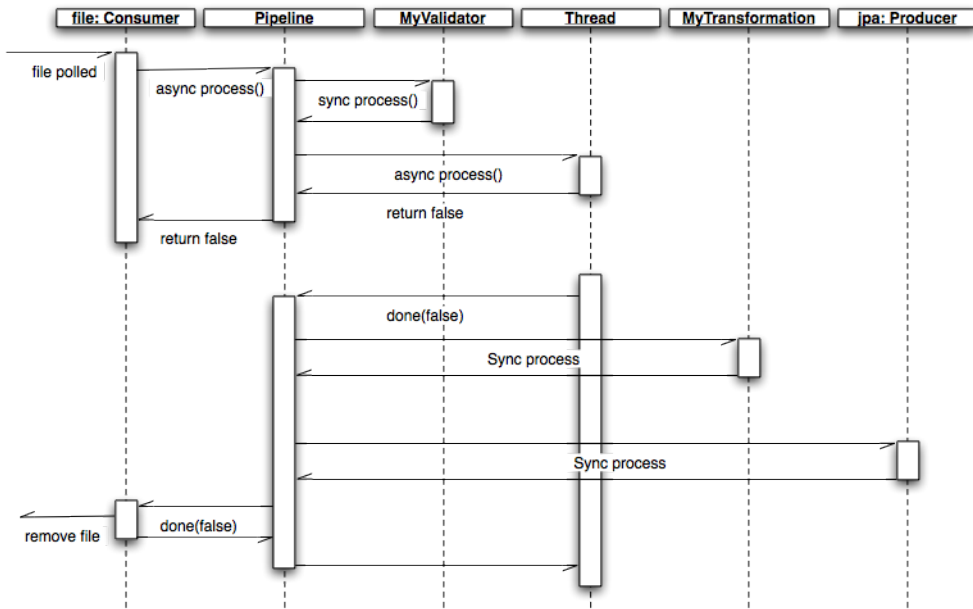

You would actually have multiple threads executing the 2nd part of the thread sequence.

### Staying synchronous in an AsyncProcessor

Generally speaking you get better throughput processing when you process things synchronously. This is due to the fact that starting up an asynchronous thread and doing a context switch to it adds a little bit of overhead. So it is generally encouraged that AsyncProcessors do as much work as they can synchronously. When they get to a step that would block for a long time, at that point they should return from the process call and let the caller know that it will be completing the call asynchronously.

## IMPLEMENTING VIRTUAL TOPICS ON OTHER JMS PROVIDERS

ActiveMQ supports Virtual Topics since durable topic subscriptions kinda suck (see this page for more detail) mostly since they don't support Competing Consumers.

Most folks want Queue semantics when consuming messages; so that you can support Competing Consumers for load balancing along with things like Message Groups and Exclusive Consumers to preserve ordering or partition the queue across consumers.

However if you are using another JMS provider you can implement Virtual Topics by switching to ActiveMQ 😊 or you can use the following Camel pattern.

First here's the ActiveMQ approach.

- send to **activemq:topic:VirtualTopic.Orders**
- for consumer A consume from **activemq:Consumer.A.VirtualTopic.Orders**

When using another message broker use the following pattern

- send to **jms:Orders**
- add this route with a to() for each logical durable topic subscriber

```
from("jms:Orders").to("jms:Consumer.A", "jms:Consumer.B", ...);
```

- for consumer A consume from **jms:Consumer.A**

## WHAT'S THE CAMEL TRANSPORT FOR CXF

In CXF you offer or consume a webservice by defining its address. The first part of the address specifies the protocol to use. For example address="http://localhost:9000" in an endpoint configuration means your service will be offered using the http protocol on port 9000 of localhost. When you integrate Camel Transport into CXF you get a new transport "camel". So you can specify address="camel://direct:MyEndpointName" to bind the CXF service address to a camel direct endpoint.

Technically speaking Camel transport for CXF is a component which implements the CXF transport API with the Camel core library. This allows you to use camel's routing engine and integration patterns support smoothly together with your CXF services.

## INTEGRATE CAMEL INTO CXF TRANSPORT LAYER

To include the Camel Transport into your CXF bus you use the CamelTransportFactory. You can do this in Java as well as in Spring.

### Setting up the Camel Transport in Spring

You can use the following snippet in your applicationcontext if you want to configure anything special. If you only want to activate the camel transport you do not have to do anything in your

application context. As soon as you include the camel-cxf jar in your app cxf will scan the jar and load a CamelTransportFactory for you.

```
<bean class="org.apache.camel.component.cxf.transport.CamelTransportFactory">
  <property name="bus" ref="cxf" />
  <property name="camelContext" ref="camelContext" />
  <property name="transportIds">
    <list>
      <value>http://cxf.apache.org/transport/camel</value>
    </list>
  </property>
</bean>
```

## Integrating the Camel Transport in a programmatic way

Camel transport provides a setContext method that you could use to set the Camel context into the transport factory. If you want this factory take effect, you need to register the factory into the CXF bus. Here is a full example for you.

```
import org.apache.cxf.Bus;
import org.apache.cxf.BusFactory;
import org.apache.cxf.transport.ConduitInitiatorManager;
import org.apache.cxf.transport.DestinationFactoryManager;
...

BusFactory bf = BusFactory.newInstance();
Bus bus = bf.createBus();
CamelTransportFactory camelTransportFactory = new CamelTransportFactory();
camelTransportFactory.setCamelContext(context)
// register the conduit initiator
ConduitInitiatorManager cim = bus.getExtension(ConduitInitiatorManager.class);
cim.registerConduitInitiator(CamelTransportFactory.TRANSPORT_ID,
camelTransportFactory);
// register the destination factory
DestinationFactoryManager dfm = bus.getExtension(DestinationFactoryManager.class);
dfm.registerDestinationFactory(CamelTransportFactory.TRANSPORT_ID,
camelTransportFactory);
// set or bus as the default bus for cxf
BusFactory.setDefaultBus(bus);
```

## CONFIGURE THE DESTINATION AND CONDUIT

### Namespace

The elements used to configure an Camel transport endpoint are defined in the namespace `http://cxf.apache.org/transport/camel`. It is commonly referred to using the prefix `camel`. In order to use the Camel transport configuration elements you will need to add the lines shown below to the beans element of your endpoint's configuration file. In addition,

you will need to add the configuration elements' namespace to the `xsi:schemaLocation` attribute.

**Listing 4. Adding the Configuration Namespace**

```
<beans ...
  xmlns:camel="http://cxf.apache.org/transports/camel
  ...
  xsi:schemaLocation="...
                        http://cxf.apache.org/transports/camel
                        http://cxf.apache.org/transports/camel.xsd
  ...>
```

### The destination element

You configure an Camel transport server endpoint using the `camel:destination` element and its children. The `camel:destination` element takes a single attribute, `name`, the specifies the WSDL port element that corresponds to the endpoint. The value for the `name` attribute takes the form `portQName.camel-destination`. The example below shows the `camel:destination` element that would be used to add configuration for an endpoint that was specified by the WSDL fragment `<port binding="widgetSOAPBinding" name="widgetSOAPPort">` if the endpoint's target namespace was `http://widgets.widgetvendor.net`.

**Listing 5. camel:destination Element**

```
...
<camel:destination name="{http://widgets/
widgetvendor.net}widgetSOAPPort.http-destination">
  <camelContext id="context" xmlns="http://activemq.apache.org/camel/schema/spring">
    <route>
      <from uri="direct:EndpointC" />
      <to uri="direct:EndpointD" />
    </route>
  </camelContext>
</camel:destination>
...
```

The `camel:destination` element has a number of child elements that specify configuration information. They are described below.

Element	Description
<code>camel-spring:camelContext</code>	You can specify the camel context in the camel destination
<code>camel:camelContextRef</code>	The camel context id which you want inject into the camel destination

## The conduit element

You configure an Camel transport client using the `camel:conduit` element and its children. The `camel:conduit` element takes a single attribute, `name`, that specifies the WSDL port element that corresponds to the endpoint. The value for the `name` attribute takes the form `portQName.camel-conduit`. For example, the code below shows the `camel:conduit` element that would be used to add configuration for an endpoint that was specified by the WSDL fragment `<port binding="widgetSOAPBinding" name="widgetSOAPPport">` if the endpoint's target namespace was `http://widgets.widgetvendor.net`.

**Listing 6. http-conf:conduit Element**

```
...
<camelContext id="conduit_context" xmlns="http://activemq.apache.org/camel/schema/spring">
  <route>
    <from uri="direct:EndpointA" />
    <to uri="direct:EndpointB" />
  </route>
</camelContext>

<camel:conduit name="{http://widgets/widgetvendor.net}widgetSOAPPport.camel-conduit">
  <camel:camelContextRef>conduit_context</camel:camelContextRef>
</camel:conduit>

<camel:conduit name="*.camel-conduit">
  <!-- you can also using the wild card to specify the camel-conduit that you want to
configure -->
  ...
</camel:conduit>
...
```

The `camel:conduit` element has a number of child elements that specify configuration information. They are described below.

Element	Description
<code>camel-spring:camelContext</code>	You can specify the camel context in the camel conduit
<code>camel:camelContextRef</code>	The camel context id which you want inject into the camel conduit

## EXAMPLE USING CAMEL AS A LOAD BALANCER FOR CXF

This example show how to use the camel load balance feature in CXF, and you need load the configuration file in CXF and publish the endpoints on the address "`camel://direct:EndpointA`" and "`camel://direct:EndpointB`"

```

<beans xmlns="http://www.springframework.org/schema/beans"
       xmlns:xsi="http://www.w3.org/2001/XMLSchema-instance"
       xmlns:camel="http://cxf.apache.org/transports/camel"
       xsi:schemaLocation="
http://www.springframework.org/schema/beans
http://www.springframework.org/schema/beans/spring-beans-2.5.xsd
http://cxf.apache.org/transports/camel http://cxf.apache.org/transports/
camel.xsd
http://camel.apache.org/schema/cxfEndpoint http://camel.apache.org/schema/cxf/
cxfEndpoint.xsd
http://camel.apache.org/schema/spring http://camel.apache.org/schema/spring/
camel-spring.xsd
">

  <bean id = "roundRobinRef"
class="org.apache.camel.processor.loadbalancer.RoundRobinLoadBalancer" />

  <camelContext id="dest_context" xmlns="http://camel.apache.org/schema/spring">
    <route>
      <from uri="jetty:http://localhost:9090/GreeterContext/GreeterPort"/>
      <loadBalance ref="roundRobinRef">
        <to uri="direct:EndpointA"/>
        <to uri="direct:EndpointB"/>
      </loadBalance>
    </route>
  </camelContext>

  <!-- Inject the camel context to the Camel transport's destination -->
  <camel:destination name="{http://apache.org/
hello_world_soap_http}CamelPort.camel-destination">
    <camel:camelContextRef>dest_context</camel:camelContextRef>
  </camel:destination>
</beans>

```

## COMPLETE HOWTO AND EXAMPLE FOR ATTACHING CAMEL TO CXF

Better JMS Transport for CXF Webservice using Apache Camel

# Tutorials

There now follows the documentation on camel tutorials

- Tutorial on Spring Remoting with JMS  
This tutorial is focused on different techniques with Camel for Client-Server communication.
- Tutorial introducing Camel steadily in a real life integration  
This is a very long tutorial beginning from the start; its for entry level to Camel. Its based on a real life integration, showing how Camel can be introduced in an existing solution. We do this in baby steps. The tutorial is currently work in progress, so check it out from time to time. The tutorial explains some of the inner building blocks Camel uses under the covers. This is good knowledge to have when you start using Camel on a higher abstract level where it can do wonders in a few lines of routing DSL.
- Using Camel with ServiceMix a tutorial on using Camel inside Apache ServiceMix.
- Better JMS Transport for CXF Webservice using Apache Camel Describes how to use the Camel Transport for CXF to attach a CXF Webservice to a JMS Queue
- Tutorial how to use good old Axis 1.4 with Camel  
This tutorial shows that Camel does work with the good old frameworks such as AXIS that is/was widely used for Webservice.
- Tutorial on using Camel in a Web Application  
This tutorial gives an overview of how to use Camel inside Tomcat, Jetty or any other servlet engine
- Tutorial on Camel 1.4 for Integration  
Another real-life scenario. The company sells widgets, with a somewhat unique business process (their customers periodically report what they've purchased in order to get billed). However every customer uses a different data format and protocol. This tutorial goes through the process of integrating (and testing!) several customers and their electronic reporting of the widgets they've bought, along with the company's response.
- Tutorial how to build a Service Oriented Architecture using Camel with OSGI  
The focus of this Tutorial is to introduce you how you can create, design a simple SOA solution using Camel and OSGI and deploy it in a OSGI Server like ServiceMix Kernel and Spring DM Server. The tutorial has been designed in two parts. The first part introduces basic concept while the second extends the ReportIncident tutorial part 4 to show How we can separate the different layers (domain, service, ...) of an application and deploy them in separate bundles. The Web Application has also be modified in order to communicate to the OSGI bundles.

- Examples  
While not actual tutorials you might find working through the source of the various Examples useful

## TUTORIAL ON SPRING REMOTING WITH JMS

### PREFACE

This tutorial aims to guide the reader through the stages of creating a project which uses Camel to facilitate the routing of messages from a JMS queue to a Spring service. The route works in a synchronous fashion returning a response to the client.

- - Preface
  - Prerequisites
  - Distribution
  - About
  - Create the Camel Project
    - Update the POM with Dependencies
  - Writing the Server
    - Create the Spring Service
    - Define the Camel Routes
    - Configure Spring
    - AOP Enabled Server
    - Run the Server
  - Writing The Clients
    - Client Using The ProducerTemplate
    - Client Using Spring Remoting
    - Client Using Message Endpoint EIP Pattern
    - Run the Clients
  - Using the Camel Maven Plugin
  - Using Camel JMX
  - See Also

### PREREQUISITES

This tutorial uses Maven to setup the Camel project and for dependencies for artifacts.





## Thanks

This tutorial was kindly donated to Apache Camel by Martin Gilday.

## DISTRIBUTION

This sample is distributed with the Camel distribution as `examples/camel-example-spring-jms`.

## ABOUT

This tutorial is a simple example that demonstrates more the fact how well Camel is seamless integrated with Spring to leverage the best of both worlds. This sample is client server solution using JMS messaging as the transport. The sample has two flavors of servers and also for clients demonstrating different techniques for easy communication.

The Server is a JMS message broker that routes incoming messages to a business service that does computations on the received message and returns a response.

The EIP patterns used in this sample are:

Pattern	Description
Message Channel	We need a channel so the Clients can communicate with the server.
Message	The information is exchanged using the Camel Message interface.
Message Translator	This is where Camel shines as the message exchange between the Server and the Clients are text based strings with numbers. However our business service uses int for numbers. So Camel can do the message translation automatically.
Message Endpoint	It should be easy to send messages to the Server from the the clients. This is archived with Camels powerful Endpoint pattern that even can be more powerful combined with Spring remoting. The tutorial have clients using each kind of technique for this.
Point to Point Channel	We using JMS queues so there are only one receive of the message exchange
Event Driven Consumer	Yes the JMS broker is of course event driven and only reacts when the client sends a message to the server.

We use the following Camel components:

Component	Description
-----------	-------------

ActiveMQ	We use Apache ActiveMQ as the JMS broker on the Server side
Bean	We use the bean binding to easily route the messages to our business service. This is a very powerful component in Camel.
File	In the AOP enabled Server we store audit trails as files.
JMS	Used for the JMS messaging

## CREATE THE CAMEL PROJECT

```
mvn archetype:create -DgroupId=org.example -DartifactId=CamelWithJmsAndSpring
```

### Update the POM with Dependencies

First we need to have dependencies for the core Camel jars, its spring, jms components and finally ActiveMQ as the message broker.

```
<!-- required by both client and server -->
<dependency>
  <groupId>org.apache.camel</groupId>
  <artifactId>camel-core</artifactId>
</dependency>
<dependency>
  <groupId>org.apache.camel</groupId>
  <artifactId>camel-jms</artifactId>
</dependency>
<dependency>
  <groupId>org.apache.camel</groupId>
  <artifactId>camel-spring</artifactId>
</dependency>
<dependency>
  <groupId>org.apache.activemq</groupId>
  <artifactId>activemq-camel</artifactId>
</dependency>
```

As we use spring xml configuration for the ActiveMQ JMS broker we need this dependency:

```
<!-- xbean is required for ActiveMQ broker configuration in the spring xml file -->
<dependency>
  <groupId>org.apache.xbean</groupId>
  <artifactId>xbean-spring</artifactId>
</dependency>
```

And dependencies for the AOP enable server example. These dependencies are of course only needed if you need full blown AOP stuff using Aspectj with bytecode instrumentation.

```
<!-- required jars for aspectj AOP support -->
<dependency>
  <groupId>org.springframework</groupId>
  <artifactId>spring-aop</artifactId>
  <version>${spring-version}</version>
```



For the purposes of the tutorial a single Maven project will be used for both the client and server. Ideally you would break your application down into the appropriate components.

```
</dependency>
<dependency>
  <groupId>org.springframework</groupId>
  <artifactId>spring-aop</artifactId>
  <version>${spring-version}</version>
</dependency>
<dependency>
  <groupId>org.aspectj</groupId>
  <artifactId>aspectjrt</artifactId>
  <version>1.6.2</version>
</dependency>
<dependency>
  <groupId>org.aspectj</groupId>
  <artifactId>aspectjweaver</artifactId>
  <version>1.6.2</version>
</dependency>
<dependency>
  <groupId>cglib</groupId>
  <artifactId>cglib-nodep</artifactId>
  <version>2.1_3</version>
</dependency>
```

## WRITING THE SERVER

### Create the Spring Service

For this example the Spring service (= our business service) on the server will be a simple multiplier which trebles in the received value.

```
public interface Multiplier {

    /**
     * Multiplies the given number by a pre-defined constant.
     *
     * @param originalNumber The number to be multiplied
     * @return The result of the multiplication
     */
    int multiply(int originalNumber);
}
```

And the implementation of this service is:

```
@Service(value = "multiplier")
public class Treble implements Multiplier {
```

```

    public int multiply(final int originalNumber) {
        return originalNumber * 3;
    }
}

```

Notice that this class has been annotated with the `@Service` spring annotation. This ensures that this class is registered as a bean in the registry with the given name **multiplier**.

## Define the Camel Routes

```

public class ServerRoutes extends RouteBuilder {

    @Override
    public void configure() throws Exception {
        // route from the numbers queue to our business that is a spring bean
        // registered with the id=multiplier
        // Camel will introspect the multiplier bean and find the best candidate of
        // the method to invoke.
        // You can add annotations etc to help Camel find the method to invoke.
        // As our multiplier bean only have one method its easy for Camel to find the
        // method to use.
        from("jms:queue:numbers").to("multiplier");

        // Camel has several ways to configure the same routing, we have defined some
        // of them here below

        // as above but with the bean: prefix
        //from("jms:queue:numbers").to("bean:multiplier");

        // beanRef is using explicitly bean bindings to lookup the multiplier bean and
        // invoke the multiply method
        //from("jms:queue:numbers").beanRef("multiplier", "multiply");

        // the same as above but expressed as a URI configuration
        //from("activemq:queue:numbers").to("bean:multiplier?methodName=multiply");

        // the STOP command
        from("jms:queue:stop").to("shutdown");
    }
}

```

This defines a Camel route *from* the JMS queue named **numbers** to the Spring bean named **multiplier**. Camel will create a consumer to the JMS queue which forwards all received messages onto the the Spring bean, using the method named **multiply**.

## Configure Spring

The Spring config file is placed under `META-INF/spring` as this is the default location used by the Camel Maven Plugin, which we will later use to run our server.

First we need to do the standard scheme declarations in the top. In the camel-server.xml we are using spring beans as the default **bean:** namespace and springs **context:**. For configuring ActiveMQ we use **broker:** and for Camel we of course have **camel:**. Notice that we don't use version numbers for the camel-spring schema. At runtime the schema is resolved in the Camel bundle. If we use a specific version number such as 1.4 then its IDE friendly as it would be able to import it and provide smart completion etc. See Xml Reference for further details.

```
<beans xmlns="http://www.springframework.org/schema/beans"
       xmlns:xsi="http://www.w3.org/2001/XMLSchema-instance"
       xmlns:context="http://www.springframework.org/schema/context"
       xmlns:camel="http://camel.apache.org/schema/spring"
       xmlns:broker="http://activemq.apache.org/schema/core"
       xsi:schemaLocation="
http://www.springframework.org/schema/beans http://www.springframework.org/
schema/beans/spring-beans-2.5.xsd
http://www.springframework.org/schema/context http://www.springframework.org/
schema/context/spring-context-2.5.xsd
http://camel.apache.org/schema/spring http://camel.apache.org/schema/spring/
camel-spring.xsd
http://activemq.apache.org/schema/core http://activemq.apache.org/schema/core/
activemq-core-5.2.0.xsd">
```

We use Spring annotations for doing IoC dependencies and its component-scan features comes to the rescue as it scans for spring annotations in the given package name:

```
<!-- let Spring do its IoC stuff in this package -->
<context:component-scan base-package="org.apache.camel.example.server"/>
```

Camel will of course not be less than Spring in this regard so it supports a similar feature for scanning of Routes. This is configured as shown below.

Notice that we also have enabled the JMXAgent so we will be able to introspect the Camel Server with a JMX Console.

```
<!-- declare a camel context that scans for classes that is RouteBuilder
in the package org.apache.camel.example.server -->
<camel:camelContext id="camel">
  <camel:package>org.apache.camel.example.server</camel:package>
  <!-- enable JMX connector so we can connect to the server and browse mbeans -->
  <!-- Camel will log at INFO level the service URI to use for connecting with
jconsole -->
  <camel:jmxAgent id="agent" createConnector="true"/>
</camel:camelContext>
```

The ActiveMQ JMS broker is also configured in this xml file. We set it up to listen on TCP port 61616.

```
<!-- lets configure the ActiveMQ JMS broker server to listen on TCP 61616 -->
<broker:broker useJmx="false" persistent="false" brokerName="localhost">
  <broker:transportConnectors>
    <broker:transportConnector name="tcp" uri="tcp://localhost:61616"/>
  </broker:transportConnectors>
</broker:broker>
```

As this examples uses JMS then Camel needs a JMS component that is connected with the ActiveMQ broker. This is configured as shown below:

```
<!-- lets configure the Camel ActiveMQ to use the ActiveMQ broker declared above -->
<bean id="jms" class="org.apache.activemq.camel.component.ActiveMQComponent">
  <property name="brokerURL" value="tcp://localhost:61616"/>
</bean>
```

**Notice:** The JMS component is configured in standard Spring beans, but the gem is that the bean id can be referenced from Camel routes - meaning we can do routing using the JMS Component by just using **jms:** prefix in the route URI. What happens is that Camel will find in the Spring Registry for a bean with the id="jms". Since the bean id can have arbitrary name you could have named it id="jmsbroker" and then referenced to it in the routing as `from="jmsbroker:queue:numbers").to("multiplier");` We use the vm protocol to connect to the ActiveMQ server as its embedded in this application.

component-scan	Defines the package to be scanned for Spring stereotype annotations, in this case, to load the "multiplier" bean
camel-context	Defines the package to be scanned for Camel routes. Will find the ServerRoutes class and create the routes contained within it
jms bean	Creates the Camel JMS component

## AOP Enabled Server

The example has an enhanced Server example that uses fullblown AspectJ AOP for doing a audit tracking of invocations of the business service.

We leverage Spring AOP support in the `{camel-server-aop.xml}` configuration file. First we must declare the correct XML schema's to use:

```
<beans xmlns="http://www.springframework.org/schema/beans"
  xmlns:xsi="http://www.w3.org/2001/XMLSchema-instance"
  xmlns:aop="http://www.springframework.org/schema/aop"
  xmlns:camel="http://camel.apache.org/schema/spring"
  xsi:schemaLocation="
    http://www.springframework.org/schema/beans http://www.springframework.org/
schema/beans/spring-beans-2.5.xsd
    http://www.springframework.org/schema/aop http://www.springframework.org/
schema/aop/spring-aop-2.5.xsd
    http://camel.apache.org/schema/spring http://camel.apache.org/schema/spring/
camel-spring.xsd">
```

Then we include all the existing configuration from the normal server example:

```
<!-- import the normal server that is the JMS broker -->
<import resource="camel-server.xml"/>
```

Then we enable the AspectJ AOP auto proxy feature of Spring that will scan for classes annotated with the `@Aspect` annotation:

```
<!-- turn on AspectJ AOP to weave all @Aspects beans declared in this spring xml file -->
-->
<aop:aspectj-autoproxy/>
```

Then we define our Audit tracker bean that does the actual audit logging. It's also the class that is annotated with the `@Aspect` so Spring will pick this up, as the aspect.

```
<!-- Aspect that tracks all the invocations of the business service -->
<bean id="AuditTracker" class="org.apache.camel.example.server.AuditTracker">
  <!-- define what store to use for audit backup -->
  <property name="store" ref="AuditStore"/>
</bean>
```

And the gem is that we inject the AuditTracker aspect bean with a Camel endpoint that defines where the audit should be stored. Noticed how easy it is to setup as we have just defined an endpoint URI that is file based, meaning that we stored the audit tracks as files. We can change this store to any Camel components as we wish. To store it on a JMS queue simply change the URI to **jms:queue:audit**.

```
<!-- the audit store endpoint is configured as file based -->
<camel:endpoint id="AuditStore" uri="file://target/store?append=false"/>
```

And the full blown Aspect for the audit tracker java code:

```
/**
 * For audit tracking of all incoming invocations of our business (Multiplier)
 */
@Aspect
public class AuditTracker {

    // endpoint we use for backup store of audit tracks
    private Endpoint store;

    @Required
    public void setStore(Endpoint store) {
        this.store = store;
    }

    @Before("execution(int org.apache.camel.example.server.Multiplier.multiply(int))
    && args(originalNumber)")
    public void audit(int originalNumber) throws Exception {
        String msg = "Someone called us with this number " + originalNumber;
        System.out.println(msg);

        // now send the message to the backup store using the Camel Message Endpoint
        pattern
        Exchange exchange = store.createExchange();
        exchange.getIn().setBody(msg);
        store.createProducer().process(exchange);
    }
}
```

## Run the Server

The Server is started using the `org.apache.camel.spring.Main` class that can start camel-spring application out-of-the-box. The Server can be started in several flavors:

- as a standard java main application - just start the `org.apache.camel.spring.Main` class
- using maven `java:exec`
- using `camel:run`

In this sample as there are two servers (with and without AOP) we have prepared some profiles in maven to start the Server of your choice.

The server is started with:

```
mvn compile exec:java -PCamelServer
```

Or for the AOP enabled Server example:

```
mvn compile exec:java -PCamelServerAOP
```

## WRITING THE CLIENTS

This sample has three clients demonstrating different Camel techniques for communication

- CamelClient using the `ProducerTemplate` for Spring template style coding
- CamelRemoting using Spring Remoting
- CamelEndpoint using the Message Endpoint EIP pattern using a neutral Camel API

### Client Using The `ProducerTemplate`

We will initially create a client by directly using `ProducerTemplate`. We will later create a client which uses Spring remoting to hide the fact that messaging is being used.

```
<beans xmlns="http://www.springframework.org/schema/beans"
  xmlns:xsi="http://www.w3.org/2001/XMLSchema-instance"
  xmlns:camel="http://camel.apache.org/schema/spring"
  xsi:schemaLocation="
    http://www.springframework.org/schema/beans http://www.springframework.org/
schema/beans/spring-beans-2.5.xsd
    http://camel.apache.org/schema/spring http://camel.apache.org/schema/spring/
camel-spring.xsd">

<camel:camelContext id="camel"/>
<camel:template id="camelTemplate"/>

<!-- Camel JMSProducer to be able to send messages to a remote Active MQ server -->
<bean id="jms" class="org.apache.activemq.camel.component.ActiveMQComponent">
  <property name="brokerURL" value="tcp://localhost:61616"/>
</bean>
```

The client will not use the Camel Maven Plugin so the Spring XML has been placed in `src/main/resources` to not conflict with the server configs.

`camelContext` The Camel context is defined but does not contain any routes



template	The <code>ProducerTemplate</code> is used to place messages onto the JMS queue
jms bean	This initialises the Camel JMS component, allowing us to place messages onto the queue

And the `CamelClient` source code:

```
public static void main(final String[] args) throws Exception {
    System.out.println("Notice this client requires that the CamelServer is already
running!");

    ApplicationContext context = new
ClassPathXmlApplicationContext("camel-client.xml");

    // get the camel template for Spring template style sending of messages (=
producer)
    ProducerTemplate camelTemplate = (ProducerTemplate)
context.getBean("camelTemplate");

    System.out.println("Invoking the multiply with 22");
    // as opposed to the CamelClientRemoting example we need to define the service URI
in this java code
    int response = (Integer)camelTemplate.sendBody("jms:queue:numbers",
ExchangePattern.InOut, 22);
    System.out.println("... the result is: " + response);

    System.exit(0);
}
```

The `ProducerTemplate` is retrieved from a Spring `ApplicationContext` and used to manually place a message on the "numbers" JMS queue. The exchange pattern (**ExchangePattern.InOut**) states that the call should be synchronous, and that we will receive a response.

Before running the client be sure that both the ActiveMQ broker and the `CamelServer` are running.

## Client Using Spring Remoting

Spring Remoting "eases the development of remote-enabled services". It does this by allowing you to invoke remote services through your regular Java interface, masking that a remote service is being called.

```
<!-- Camel proxy for a given service, in this case the JMS queue -->
<camel:proxy
    id="multiplierProxy"
    serviceInterface="org.apache.camel.example.server.Multiplier"
    serviceUrl="jms:queue:numbers"/>
```

The snippet above only illustrates the different and how Camel easily can setup and use Spring Remoting in one line configurations.

The **proxy** will create a proxy service bean for you to use to make the remote invocations. The **serviceInterface** property details which Java interface is to be implemented by the proxy. **serviceUrl** defines where messages sent to this proxy bean will be directed. Here we define the JMS endpoint with the "numbers" queue we used when working with Camel template directly. The value of the **id** property is the name that will be given to the bean when it is exposed through the Spring ApplicationContext. We will use this name to retrieve the service in our client. I have named the bean *multiplierProxy* simply to highlight that it is not the same multiplier bean as is being used by CamelServer. They are in completely independent contexts and have no knowledge of each other. As you are trying to mask the fact that remoting is being used in a real application you would generally not include proxy in the name.

And the Java client source code:

```
public static void main(final String[] args) {
    System.out.println("Notice this client requires that the CamelServer is already
running!");

    ApplicationContext context = new
ClassPathXmlApplicationContext("camel-client-remoting.xml");
    // just get the proxy to the service and we as the client can use the "proxy" as
it was
    // a local object we are invoking. Camel will under the covers do the remote
communication
    // to the remote ActiveMQ server and fetch the response.
    Multiplier multiplier = (Multiplier)context.getBean("multiplierProxy");

    System.out.println("Invoking the multiply with 33");
    int response = multiplier.multiply(33);
    System.out.println("... the result is: " + response);

    System.exit(0);
}
```

Again, the client is similar to the original client, but with some important differences.

1. The Spring context is created with the new *camel-client-remoting.xml*
2. We retrieve the proxy bean instead of a *ProducerTemplate*. In a non-trivial example you would have the bean injected as in the standard Spring manner.
3. The multiply method is then called directly. In the client we are now working to an interface. There is no mention of Camel or JMS inside our Java code.

## Client Using Message Endpoint EIP Pattern

This client uses the Message Endpoint EIP pattern to hide the complexity to communicate to the Server. The Client uses the same simple API to get hold of the endpoint, create an exchange that holds the message, set the payload and create a producer that does the send and receive. All done using the same neutral Camel API for **all** the components in Camel. So if the communication was socket TCP based you just get hold of a different endpoint and all the java code stays the same. That is really powerful.

Okay enough talk, show me the code!

```

public static void main(final String[] args) throws Exception {
    System.out.println("Notice this client requires that the CamelServer is already
running!");

    ApplicationContext context = new
ClassPathXmlApplicationContext("camel-client.xml");
    CamelContext camel = (CamelContext) context.getBean("camel");

    // get the endpoint from the camel context
    Endpoint endpoint = camel.getEndpoint("jms:queue:numbers");

    // create the exchange used for the communication
    // we use the in out pattern for a synchronized exchange where we expect a response
    Exchange exchange = endpoint.createExchange(ExchangePattern.InOut);
    // set the input on the in body
    // must you correct type to match the expected type of an Integer object
    exchange.getIn().setBody(11);

    // to send the exchange we need an producer to do it for us
    Producer producer = endpoint.createProducer();
    // start the producer so it can operate
    producer.start();

    // let the producer process the exchange where it does all the work in this
oneline of code
    System.out.println("Invoking the multiply with 11");
    producer.process(exchange);

    // get the response from the out body and cast it to an integer
    int response = exchange.getOut().getBody(Integer.class);
    System.out.println("... the result is: " + response);

    // stop and exit the client
    producer.stop();
    System.exit(0);
}

```

Switching to a different component is just a matter of using the correct endpoint. So if we had defined a TCP endpoint as: "mina:tcp://localhost:61616" then its just a matter of getting hold of this endpoint instead of the JMS and all the rest of the java code is exactly the same.

## Run the Clients

The Clients is started using their main class respectively.

- as a standard java main application - just start their main class
- using maven `java:exec`

In this sample we start the clients using maven:

```
mvn compile exec:java -PCamelClient
```

```
mvn compile exec:java -PCamelClientRemoting
```

```
mvn compile exec:java -PCamelClientEndpoint
```

Also see the Maven `pom.xml` file how the profiles for the clients is defined.

## USING THE CAMEL MAVEN PLUGIN

The Camel Maven Plugin allows you to run your Camel routes directly from Maven. This negates the need to create a host application, as we did with Camel server, simply to start up the container. This can be very useful during development to get Camel routes running quickly.

**Listing 7. pom.xml**

```
<build>
  <plugins>
    <plugin>
      <groupId>org.apache.camel</groupId>
      <artifactId>camel-maven-plugin</artifactId>
    </plugin>
  </plugins>
</build>
```

All that is required is a new plugin definition in your Maven POM. As we have already placed our Camel config in the default location (`camel-server.xml` has been placed in `META-INF/spring/`) we do not need to tell the plugin where the route definitions are located. Simply run `mvn camel:run`.

## USING CAMEL JMX

Camel has extensive support for JMX and allows us to inspect the Camel Server at runtime. As we have enabled the `JMXAgent` in our tutorial we can fire up the `jconsole` and connect to the following service URI: `service:jmx:rmi:///jndi/rmi://localhost:1099/jmxrmi/camel`. Notice that Camel will log at `INFO` level the JMX Connector URI:

```
...
DefaultInstrumentationAgent    INFO    JMX connector thread started on
service:jmx:rmi:///jndi/rmi://claus-acer:1099/jmxrmi/camel
...
```

In the screenshot below we can see the route and its performance metrics:

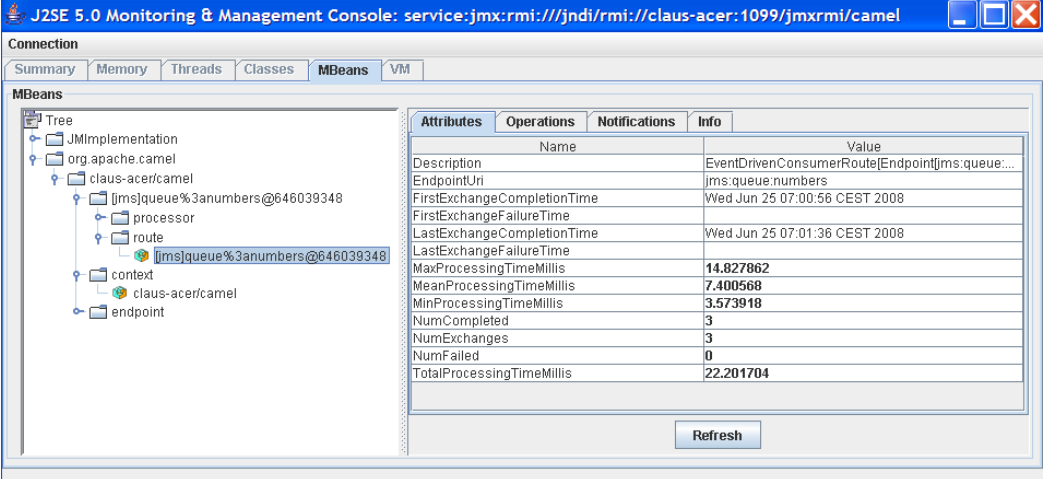

The screenshot shows the J2SE 5.0 Monitoring & Management Console. The title bar indicates the connection to 'service:jmx:rmi:///jndi/rmi://claus-acer:1099/jmxrmi/camel'. The 'MBeans' tab is selected, and a tree view on the left shows the hierarchy: JMImplementation > org.apache.camel > claus-acer/camel > route > [jms]queue%3anumbers@646039348. The right pane displays performance metrics for this route.

Attributes	Operations	Notifications	Info
Name	Value		
Description	EventDrivenConsumerRoute[Endpoint[jms:queue:...		
EndpointUri	jms:queue:numbers		
FirstExchangeCompletionTime	Wed Jun 25 07:00:56 CEST 2008		
FirstExchangeFailureTime			
LastExchangeCompletionTime	Wed Jun 25 07:01:36 CEST 2008		
LastExchangeFailureTime			
MaxProcessingTimeMillis	14.827862		
MeanProcessingTimeMillis	7.400568		
MinProcessingTimeMillis	3.573918		
NumCompleted	3		
NumExchanges	3		
NumFailed	0		
TotalProcessingTimeMillis	22.201704		

Refresh

## SEE ALSO

- Spring Remoting with JMS Example on Amin Abbaspour's Weblog

## TUTORIAL - CAMEL-EXAMPLE-REPORTINCIDENT

### INTRODUCTION

Creating this tutorial was inspired by a real life use-case I discussed over the phone with a colleague. He was working at a client whom uses a heavy-weight integration platform from a very large vendor. He was in talks with developer shops to implement a new integration on this platform. His trouble was the shop tripled the price when they realized the platform of choice. So I was wondering how we could do this integration with Camel. Can it be done, without tripling the cost 😊.

This tutorial is written during the development of the integration. I have decided to start off with a sample that isn't Camel's but standard Java and then plugin Camel as we goes. Just as when people needed to learn Spring you could consume it piece by piece, the same goes with Camel.

The target reader is person whom hasn't experience or just started using Camel.

# MOTIVATION FOR THIS TUTORIAL

I wrote this tutorial motivated as Camel lacked an example application that was based on the web application deployment model. The entire world hasn't moved to pure OSGi deployments yet.

## THE USE-CASE

The goal is to allow staff to report incidents into a central administration. For that they use client software where they report the incident and submit it to the central administration. As this is an integration in a transition phase the administration should get these incidents by email whereas they are manually added to the database. The client software should gather the incident and submit the information to the integration platform that in term will transform the report into an email and send it to the central administrator for manual processing.

The figure below illustrates this process. The end users reports the incidents using the client applications. The incident is sent to the central integration platform as webservice. The integration platform will process the incident and send an OK acknowledgment back to the client. Then the integration will transform the message to an email and send it to the administration mail server. The users in the administration will receive the emails and take it from there.

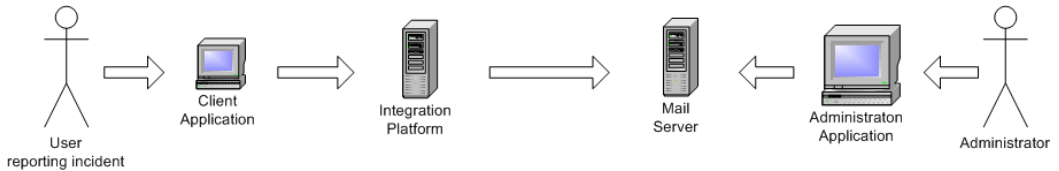

## In EIP patterns

We distill the use case as EIP patterns:

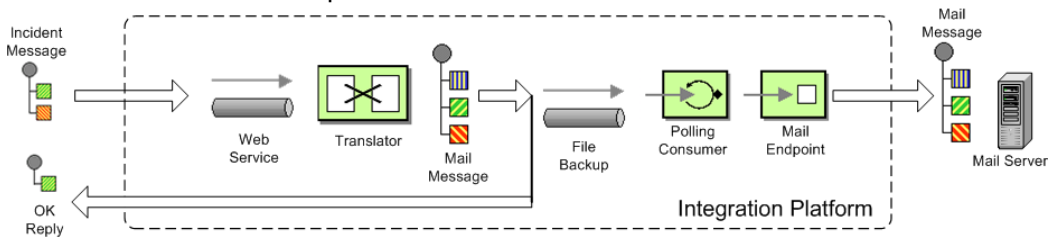

## PARTS

This tutorial is divided into sections and parts:

### Section A: Existing Solution, how to slowly use Camel

Part 1 - This first part explain how to setup the project and get a webservice exposed using Apache CXF. In fact we don't touch Camel yet.

Part 2 - Now we are ready to introduce Camel piece by piece (without using Spring or any XML configuration file) and create the full feature integration. This part will introduce different Camel's concepts and How we can build our solution using them like :

- CamelContext
- Endpoint, Exchange & Producer
- Components : Log, File

Part 3 - Continued from part 2 where we implement that last part of the solution with the event driven consumer and how to send the email through the Mail component.

### **Section B: The Camel Solution**

Part 4 - We now turn into the path of Camel where it excels - the routing.

Part 5 - Is about how embed Camel with Spring and using CXF endpoints directly in Camel

## **LINKS**

- Introduction
- Part 1
- Part 2
- Part 3
- Part 4
- Part 5

## **PART I**

### **PREREQUISITES**

This tutorial uses the following frameworks:

- Maven 2.0.9
- Apache Camel 1.4.0
- Apache CXF 2.1.1
- Spring 2.5.5

**Note:** The sample project can be downloaded, see the resources section.

### **INITIAL PROJECT SETUP**

We want the integration to be a standard .war application that can be deployed in any web container such as Tomcat, Jetty or even heavy weight application servers such as WebLogic or WebSphere. There fore we start off with the standard Maven webapp project that is created with the following long archetype command:

```
mvn archetype:create -DgroupId=org.apache.camel
-DartifactId=camel-example-reportincident -DarchetypeArtifactId=maven-archetype-webapp
```

Notice that the groupId etc. doesn't have to be org.apache.camel it can be com.mycompany.whatever. But I have used these package names as the example is an official part of the Camel distribution.

Then we have the basic maven folder layout. We start out with the webservice part where we want to use Apache CXF for the webservice stuff. So we add this to the pom.xml

```
<properties>
  <cxf-version>2.1.1</cxf-version>
</properties>

<dependency>
  <groupId>org.apache.cxf</groupId>
  <artifactId>cxf-rt-core</artifactId>
  <version>${cxf-version}</version>
</dependency>
<dependency>
  <groupId>org.apache.cxf</groupId>
  <artifactId>cxf-rt-frontend-jaxws</artifactId>
  <version>${cxf-version}</version>
</dependency>
<dependency>
  <groupId>org.apache.cxf</groupId>
  <artifactId>cxf-rt-transport-http</artifactId>
  <version>${cxf-version}</version>
</dependency>
```

## DEVELOPING THE WEBSERVICE

As we want to develop webservice with the contract first approach we create our .wsdl file. As this is an example we have simplified the model of the incident to only include 8 fields. In real life the model would be a bit more complex, but not too much.

We put the wsdl file in the folder src/main/webapp/WEB-INF/wsdl and name the file report\_incident.wsdl.

```
<?xml version="1.0" encoding="ISO-8859-1"?>
<wsdl:definitions xmlns:soap="http://schemas.xmlsoap.org/wsdl/soap/"
  xmlns:tns="http://reportincident.example.camel.apache.org"
  xmlns:xs="http://www.w3.org/2001/XMLSchema"
  xmlns:http="http://schemas.xmlsoap.org/wsdl/http/"
  xmlns:wsdl="http://schemas.xmlsoap.org/wsdl/"
  targetNamespace="http://reportincident.example.camel.apache.org">

  <!-- Type definitions for input- and output parameters for webservice -->
  <wsdl:types>
    <xs:schema targetNamespace="http://reportincident.example.camel.apache.org">
      <xs:element name="inputReportIncident">
        <xs:complexType>
          <xs:sequence>
```



```

name="incidentId" />
name="incidentDate" />
name="givenName" />
name="familyName" />
name="summary" />
name="details" />
name="email" />
name="phone" />
</xs:sequence>
</xs:complexType>
</xs:element>
<xs:element name="outputReportIncident">
  <xs:complexType>
    <xs:sequence>
      <xs:element type="xs:string"
name="code" />
    </xs:sequence>
  </xs:complexType>
</xs:element>
</xs:schema>
</wsdl:types>

<!-- Message definitions for input and output -->
<wsdl:message name="inputReportIncident">
  <wsdl:part name="parameters" element="tns:inputReportIncident" />
</wsdl:message>
<wsdl:message name="outputReportIncident">
  <wsdl:part name="parameters" element="tns:outputReportIncident" />
</wsdl:message>

<!-- Port (interface) definitions -->
<wsdl:portType name="ReportIncidentEndpoint">
  <wsdl:operation name="ReportIncident">
    <wsdl:input message="tns:inputReportIncident" />
    <wsdl:output message="tns:outputReportIncident" />
  </wsdl:operation>
</wsdl:portType>

<!-- Port bindings to transports and encoding - HTTP, document literal
encoding is used -->
<wsdl:binding name="ReportIncidentBinding" type="tns:ReportIncidentEndpoint">
  <soap:binding transport="http://schemas.xmlsoap.org/soap/http" />
  <wsdl:operation name="ReportIncident">
    <soap:operation
soapAction="http://reportincident.example.camel.apache.org/ReportIncident"
style="document" />
  </wsdl:operation>
</wsdl:binding>
</wsdl:service>
</wsdl:definitions>

```

```

        <soap:body parts="parameters" use="literal"/>
    </wsdl:input>
    <wsdl:output>
        <soap:body parts="parameters" use="literal"/>
    </wsdl:output>
    </wsdl:operation>
</wsdl:binding>

<!-- Service definition -->
<wsdl:service name="ReportIncidentService">
    <wsdl:port name="ReportIncidentPort"
binding="tns:ReportIncidentBinding">
        <soap:address
location="http://reportincident.example.camel.apache.org"/>
    </wsdl:port>
</wsdl:service>

</wsdl:definitions>

```

## CXF wsdl2java

Then we integrate the CXF wsdl2java generator in the pom.xml so we have CXF generate the needed POJO classes for our webservice contract.

However at first we must configure maven to live in the modern world of Java 1.5 so we must add this to the pom.xml

```

<!-- to compile with 1.5 -->
<plugin>
    <groupId>org.apache.maven.plugins</groupId>
    <artifactId>maven-compiler-plugin</artifactId>
    <configuration>
        <source>1.5</source>
        <target>1.5</target>
    </configuration>
</plugin>

```

And then we can add the CXF wsdl2java code generator that will hook into the compile goal so its automatic run all the time:

```

<!-- CXF wsdl2java generator, will plugin to the compile goal -->
<plugin>
    <groupId>org.apache.cxf</groupId>
    <artifactId>cxf-codegen-plugin</artifactId>
    <version>${cxf-version}</version>
    <executions>
        <execution>
            <id>generate-sources</id>
            <phase>generate-sources</phase>
            <configuration>
                <sourceRoot>${basedir}/target/
generated/src/main/java</sourceRoot>
            <wsdlOptions>
                <wsdlOption>

```

```

<wsdl>${basedir}/src/main/webapp/WEB-INF/wsdl/report_incident.wsdl</wsdl>
    </wsdlOption>
  </wsdlOptions>
</configuration>
<goals>
  <goal>wsdl2java</goal>
</goals>
</execution>
</executions>
</plugin>

```

You are now setup and should be able to compile the project. So running the `mvn compile` should run the CXF `wsdl2java` and generate the source code in the folder `&{basedir}/target/generated/src/main/java` that we specified in the `pom.xml` above. Since its in the `target/generated/src/main/java` maven will pick it up and include it in the build process.

## Configuration of the web.xml

Next up is to configure the `web.xml` to be ready to use CXF so we can expose the webservice. As Spring is the center of the universe, or at least is a very important framework in today's Java land we start with the listener that kick-starts Spring. This is the usual piece of code:

```

<!-- the listener that kick-starts Spring -->
  <listener>

<listener-class>org.springframework.web.context.ContextLoaderListener</listener-class>
</listener>

```

And then we have the CXF part where we define the CXF servlet and its URI mappings to which we have chosen that all our webservices should be in the path `/webservices/`

```

<!-- CXF servlet -->
  <servlet>
    <servlet-name>CXFServlet</servlet-name>

<servlet-class>org.apache.cxf.transport.servlet.CXFServlet</servlet-class>
    <load-on-startup>1</load-on-startup>
  </servlet>

  <!-- all our webservices are mapped under this URI pattern -->
  <servlet-mapping>
    <servlet-name>CXFServlet</servlet-name>
    <url-pattern>/webservices/*</url-pattern>
  </servlet-mapping>

```

Then the last piece of the puzzle is to configure CXF, this is done in a spring XML that we link to from the `web.xml` by the standard Spring `contextConfigLocation` property in the `web.xml`

```

<!-- location of spring xml files -->
  <context-param>

```

```

    <param-name>contextConfigLocation</param-name>
    <param-value>classpath:cxf-config.xml</param-value>
</context-param>

```

We have named our CXF configuration file `cxf-config.xml` and its located in the root of the classpath. In Maven land that is we can have the `cxf-config.xml` file in the `src/main/resources` folder. We could also have the file located in the `WEB-INF` folder for instance `<param-value>/WEB-INF/cxf-config.xml</param-value>`.

## Getting rid of the old jsp world

The maven archetype that created the basic folder structure also created a sample `.jsp` file `index.jsp`. This file `src/main/webapp/index.jsp` should be deleted.

## Configuration of CXF

The `cxf-config.xml` is as follows:

```

<beans xmlns="http://www.springframework.org/schema/beans"
       xmlns:xsi="http://www.w3.org/2001/XMLSchema-instance"
       xmlns:jaxws="http://cxf.apache.org/jaxws"
       xsi:schemaLocation="
           http://www.springframework.org/schema/beans http://www.springframework.org/
           schema/beans/spring-beans-2.0.xsd
           http://cxf.apache.org/jaxws http://cxf.apache.org/schemas/jaxws.xsd">

    <import resource="classpath:META-INF/cxf/cxf.xml"/>
    <import resource="classpath:META-INF/cxf/cxf-extension-soap.xml"/>
    <import resource="classpath:META-INF/cxf/cxf-servlet.xml"/>

    <!-- implementation of the webservice -->
    <bean id="reportIncidentEndpoint"
        class="org.apache.camel.example.reportincident.ReportIncidentEndpointImpl"/>

    <!-- export the webservice using jaxws -->
    <jaxws:endpoint id="reportIncident"
        implementor="#reportIncidentEndpoint"
        address="/incident"
        wsdlLocation="/WEB-INF/wsdl/report_incident.wsdl"
        endpointName="s:ReportIncidentPort"
        serviceName="s:ReportIncidentService"
        xmlns:s="http://reportincident.example.camel.apache.org"/>

</beans>

```

The configuration is standard CXF and is documented at the Apache CXF website.

The 3 import elements is needed by CXF and they must be in the file.

Noticed that we have a spring bean **reportIncidentEndpoint** that is the implementation of the webservice endpoint we let CXF expose.

Its linked from the `jaxws` element with the `implementator` attribute as we use the `#` mark to

identify its a reference to a spring bean. We could have stated the classname directly as `implementor="org.apache.camel.example.reportincident.ReportIncidentEndpoint"` but then we lose the ability to let the `ReportIncidentEndpoint` be configured by spring. The **address** attribute defines the relative part of the URL of the exposed webservice. **wSDLLocation** is an optional parameter but for persons like me that likes contract-first we want to expose our own .wsdl contracts and not the auto generated by the frameworks, so with this attribute we can link to the real .wsdl file. The last stuff is needed by CXF as you could have several services so it needs to know which this one is. Configuring these is quite easy as all the information is in the wsdl already.

## Implementing the ReportIncidentEndpoint

Phew after all these meta files its time for some java code so we should code the implementor of the webservice. So we fire up `mvn compile` to let CXF generate the POJO classes for our webservice and we are ready to fire up a Java editor.

You can use `mvn idea:idea` or `mvn eclipse:eclipse` to create project files for these editors so you can load the project. However IDEA has been smarter lately and can load a pom.xml directly.

As we want to quickly see our webservice we implement just a quick and dirty as it can get. At first beware that since its jaxws and Java 1.5 we get annotations for the money, but they reside on the interface so we can remove them from our implementations so its a nice plain POJO again:

```
package org.apache.camel.example.reportincident;

/**
 * The webservice we have implemented.
 */
public class ReportIncidentEndpointImpl implements ReportIncidentEndpoint {

    public OutputReportIncident reportIncident(InputReportIncident parameters) {
        System.out.println("Hello ReportIncidentEndpointImpl is called from " +
            parameters.getGivenName());

        OutputReportIncident out = new OutputReportIncident();
        out.setCode("OK");
        return out;
    }
}
```

We just output the person that invokes this webservice and returns a OK response. This class should be in the maven source root folder `src/main/java` under the package name `org.apache.camel.example.reportincident`. Beware that the maven archetype tool didn't create the `src/main/java` folder, so you should create it manually.

To test if we are home free we run `mvn clean compile`.

## Running our webservice

Now that the code compiles we would like to run it in a web container, so we add jetty to our pom.xml so we can run `mvn jetty:run`:

```
<properties>
  ...
  <jetty-version>6.1.1</jetty-version>
</properties>

<build>
  <plugins>
    ...
    <!-- so we can run mvn jetty:run -->
    <plugin>
      <groupId>org.mortbay.jetty</groupId>
      <artifactId>maven-jetty-plugin</artifactId>
      <version>${jetty-version}</version>
    </plugin>
  </plugins>
</build>
```

**Notice:** We use Jetty v6.1.1 as newer versions has troubles on my laptop. Feel free to try a newer version on your system, but v6.1.1 works flawless.

So to see if everything is in order we fire up jetty with `mvn jetty:run` and if everything is okay you should be able to access `http://localhost:8080`.

Jetty is smart that it will list the correct URI on the page to our web application, so just click on the link. This is smart as you don't have to remember the exact web context URI for your application - just fire up the default page and Jetty will help you.

So where is the damn webservice then? Well as we did configure the web.xml to instruct the CXF servlet to accept the pattern `/webservices/*` we should hit this URL to get the attention of CXF: `http://localhost:8080/camel-example-reportincident/webservices`.

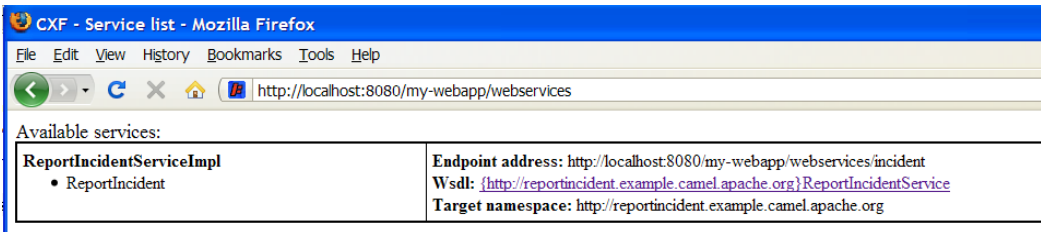

## Hitting the webservice

Now we have the webservice running in a standard .war application in a standard web container such as Jetty we would like to invoke the webservice and see if we get our code executed. Unfortunately this isn't the easiest task in the world - its not so easy as a REST URL, so we need tools for this. So we fire up our trusty webservice tool SoapUI and let it be the one to fire the webservice request and see the response.

Using SoapUI we sent a request to our webservice and we got the expected OK response and the console outputs the System.out so we are ready to code.

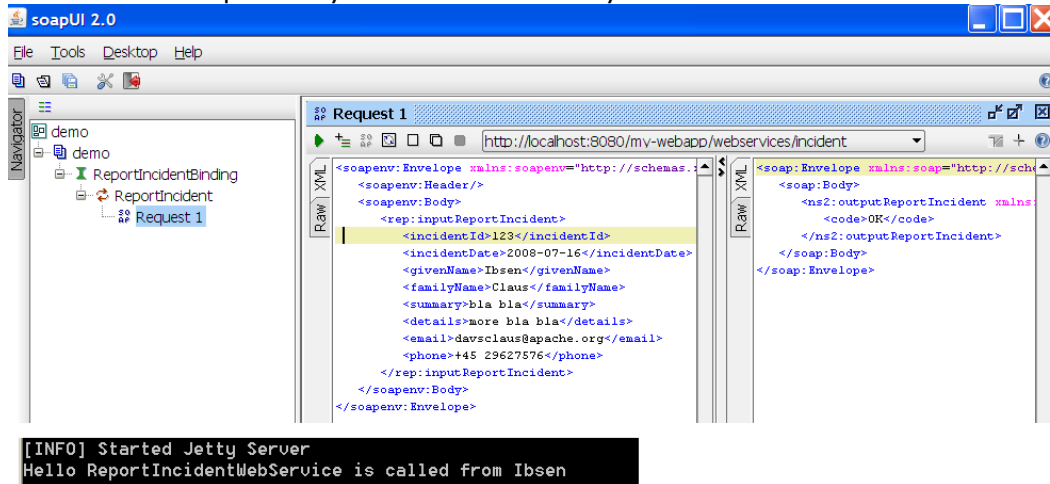

## Remote Debugging

Okay a little sidestep but wouldn't it be cool to be able to debug your code when its fired up under Jetty? As Jetty is started from maven, we need to instruct maven to use debug mode. So we set the MAVEN\_OPTS environment to start in debug mode and listen on port 5005.

```
MAVEN_OPTS=-Xmx512m -XX:MaxPermSize=128m -Xdebug
-Xrunjdwp:transport=dt_socket,server=y,suspend=n,address=5005
```

Then you need to restart Jetty so its stopped with **ctrl + c**. Remember to start a new shell to pickup the new environment settings. And start jetty again.

Then we can from our IDE attach a remote debugger and debug as we want. First we configure IDEA to attach to a remote debugger on port 5005:

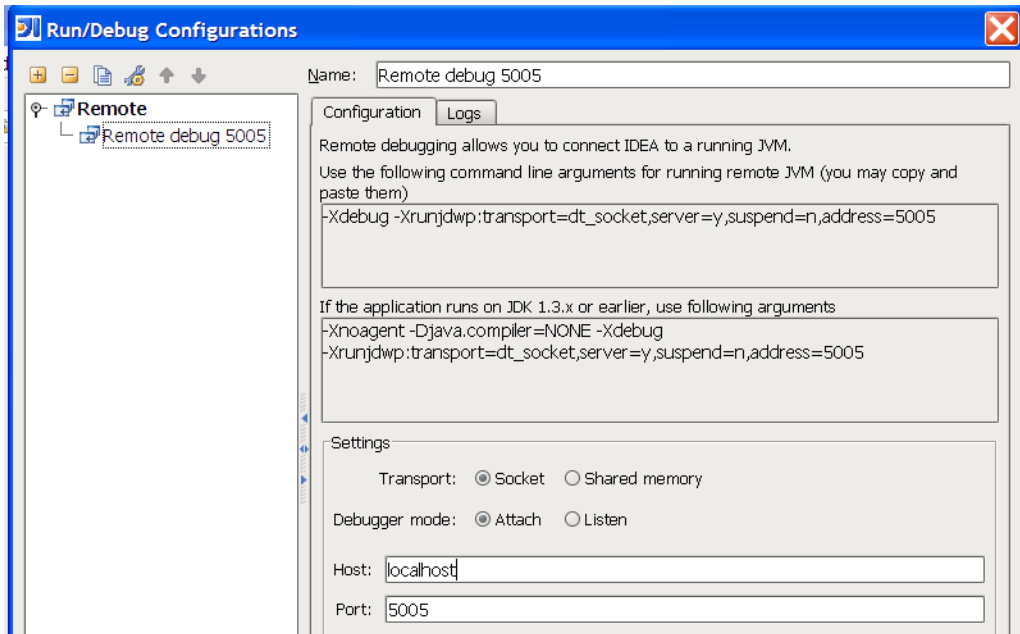

Then we set a breakpoint in our code `ReportIncidentEndpoint` and hit the `SoapUI` once again and we are broken at the breakpoint where we can inspect the parameters:



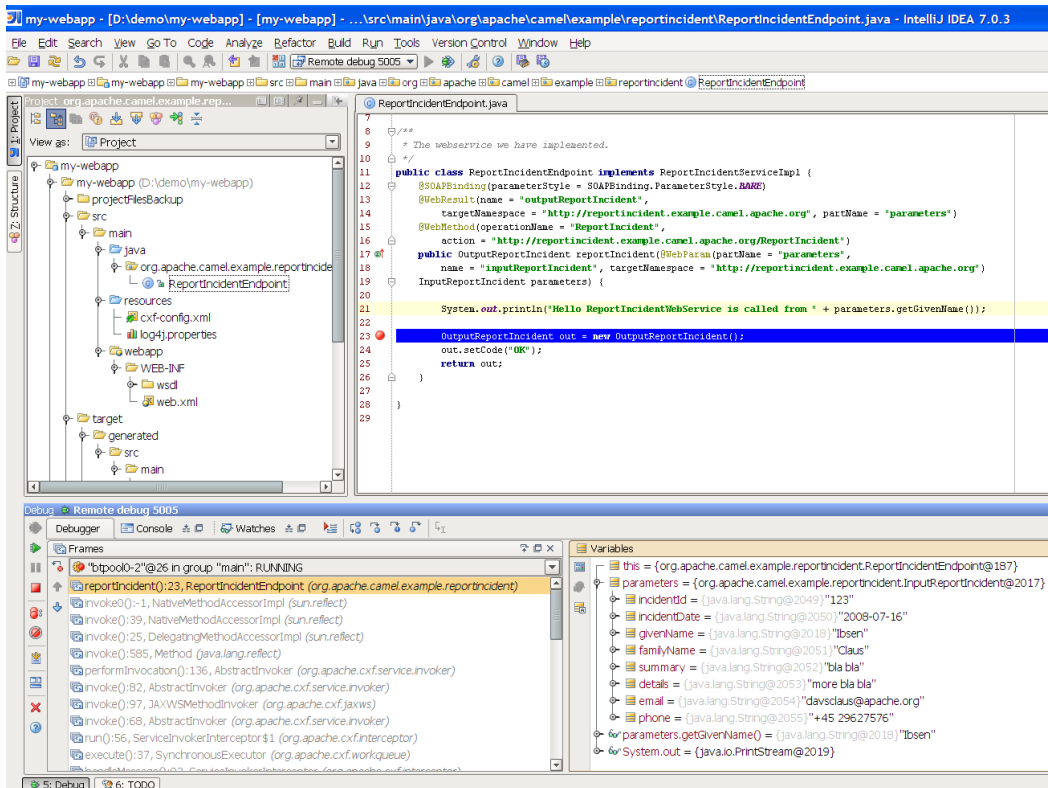

## Adding a unit test

Oh so much hard work just to hit a webservice, why can't we just use a unit test to invoke our webservice? Yes of course we can do this, and that's the next step.

First we create the folder structure `src/test/java` and `src/test/resources`. We then create the unit test in the `src/test/java` folder.

```
package org.apache.camel.example.reportincident;

import junit.framework.TestCase;

/**
 * Plain JUnit test of our webservice.
 */
public class ReportIncidentEndpointTest extends TestCase {

}
```

Here we have a plain old JUnit class. As we want to test webservices we need to start and expose our webservice in the unit test before we can test it. And JAXWS has pretty decent methods to help us here, the code is simple as:

```

import javax.xml.ws.Endpoint;
...

private static String ADDRESS = "http://localhost:9090/unittest";

protected void startServer() throws Exception {
    // We need to start a server that exposes our webservice during the unit testing
    // We use jaxws to do this pretty simple
    ReportIncidentEndpointImpl server = new ReportIncidentEndpointImpl();
    Endpoint.publish(ADDRESS, server);
}

```

The Endpoint class is the `javax.xml.ws.Endpoint` that under the covers looks for a provider and in our case its CXF - so its CXF that does the heavy lifting of exposing out webservice on the given URL address. Since our class `ReportIncidentEndpointImpl` implements the interface **ReportIncidentEndpoint** that is decorated with all the `jaxws` annotations it got all the information it need to expose the webservice. Below is the CXF `wsdl2java` generated interface:

```

/*
 *
 */

package org.apache.camel.example.reportincident;

import javax.jws.WebMethod;
import javax.jws.WebParam;
import javax.jws.WebResult;
import javax.jws.WebService;
import javax.jws.soap.SOAPBinding;
import javax.jws.soap.SOAPBinding.ParameterStyle;
import javax.xml.bind.annotation.XmlSeeAlso;

/**
 * This class was generated by Apache CXF 2.1.1
 * Wed Jul 16 12:40:31 CEST 2008
 * Generated source version: 2.1.1
 *
 */

/*
 *
 */

@WebService(targetNamespace = "http://reportincident.example.camel.apache.org", name =
"ReportIncidentEndpoint")
@XmlSeeAlso({ObjectFactory.class})
@SOAPBinding(parameterStyle = SOAPBinding.ParameterStyle.BARE)

public interface ReportIncidentEndpoint {

/*
 *

```

```

*/

    @SOAPBinding(parameterStyle = SOAPBinding.ParameterStyle.BARE)
    @WebResult(name = "outputReportIncident", targetNamespace =
"http://reportincident.example.camel.apache.org", partName = "parameters")
    @WebMethod(operationName = "ReportIncident", action =
"http://reportincident.example.camel.apache.org/ReportIncident")
    public OutputReportIncident reportIncident(
        @WebParam(partName = "parameters", name = "inputReportIncident",
targetNamespace = "http://reportincident.example.camel.apache.org")
        InputReportIncident parameters
    );
}

```

Next up is to create a webservice client so we can invoke our webservice. For this we actually use the CXF framework directly as its a bit more easier to create a client using this framework than using the JAXWS style. We could have done the same for the server part, and you should do this if you need more power and access more advanced features.

```

import org.apache.cxf.jaxws.JaxWsProxyFactoryBean;
...

protected ReportIncidentEndpoint createCXFClient() {
    // we use CXF to create a client for us as its easier than JAXWS and works
    JaxWsProxyFactoryBean factory = new JaxWsProxyFactoryBean();
    factory.setServiceClass(ReportIncidentEndpoint.class);
    factory.setAddress(ADDRESS);
    return (ReportIncidentEndpoint) factory.create();
}

```

So now we are ready for creating a unit test. We have the server and the client. So we just create a plain simple unit test method as the usual junit style:

```

public void testRendportIncident() throws Exception {
    startServer();

    ReportIncidentEndpoint client = createCXFClient();

    InputReportIncident input = new InputReportIncident();
    input.setIncidentId("123");
    input.setIncidentDate("2008-07-16");
    input.setGivenName("Claus");
    input.setFamilyName("Ibsen");
    input.setSummary("bla bla");
    input.setDetails("more bla bla");
    input.setEmail("davsclaus@apache.org");
    input.setPhone("+45 2962 7576");

    OutputReportIncident out = client.reportIncident(input);
    assertEquals("Response code is wrong", "OK", out.getCode());
}

```

Now we are nearly there. But if you run the unit test with `mvn test` then it will fail. Why!!! Well its because that CXF needs is missing some dependencies during unit testing. In fact it needs the web container, so we need to add this to our **pom.xml**.

```
<!-- cxf web container for unit testing -->
<dependency>
  <groupId>org.apache.cxf</groupId>
  <artifactId>cxf-rt-transport-http-jetty</artifactId>
  <version>${cxf-version}</version>
  <scope>test</scope>
</dependency>
```

Well what is that, CXF also uses Jetty for unit test - well its just shows how agile, embedable and popular Jetty is.

So lets run our junit test with, and it reports:

```
mvn test
Tests run: 1, Failures: 0, Errors: 0, Skipped: 0
[INFO] BUILD SUCCESSFUL
```

Yep thats it for now. We have a basic project setup.

## END OF PART I

Thanks for being patient and reading all this more or less standard Maven, Spring, JAXWS and Apache CXF stuff. Its stuff that is well covered on the net, but I wanted a full fledged tutorial on a maven project setup that is web service ready with Apache CXF. We will use this as a base for the next part where we demonstrate how Camel can be digested slowly and piece by piece just as it was back in the times when was introduced and was learning the Spring framework that we take for granted today.

## RESOURCES

- [Apache CXF user guide](#)

	<b>Name</b>	<b>Size</b>	<b>Creator</b>	<b>Date</b>	<b>Comment</b>
	 tutorial_reportincident_part-one.zip	14 kb	Claus Ibsen	Jul 17, 2008	

## LINKS

- [Introduction](#)
- [Part 1](#)
- [Part 2](#)
- [Part 3](#)
- [Part 4](#)
- [Part 5](#)

## PART 2

### ADDING CAMEL

In this part we will introduce Camel so we start by adding Camel to our pom.xml:

```
<properties>
    ...
    <camel-version>1.4.0</camel-version>
</properties>

<!-- camel -->
<dependency>
    <groupId>org.apache.camel</groupId>
    <artifactId>camel-core</artifactId>
    <version>${camel-version}</version>
</dependency>
```

That's it, only **one** dependency for now.

Now we turn towards our webservice endpoint implementation where we want to let Camel have a go at the input we receive. As Camel is very non invasive its basically a .jar file then we can just grab Camel but creating a new instance of `DefaultCamelContext` that is the hearth of Camel its context.

```
CamelContext camel = new DefaultCamelContext();
```

In fact we create a constructor in our webservice and add this code:

```
private CamelContext camel;

public ReportIncidentEndpointImpl() throws Exception {
    // create the camel context that is the "heart" of Camel
    camel = new DefaultCamelContext();

    // add the log component
    camel.addComponent("log", new LogComponent());

    // start Camel
    camel.start();
}
```

### LOGGING THE "HELLO WORLD"

Here at first we want Camel to log the **givenName** and **familyName** parameters we receive, so we add the `LogComponent` with the key **log**. And we must **start** Camel before its ready to act.

Then we change the code in the method that is invoked by Apache CXF when a webservice request arrives. We get the name and let Camel have a go at it in the new method we create **sendToCamel**:



## Synchronize IDE

If you continue from part I, remember to update your editor project settings since we have introduced new .jar files. For instance IDEA has a feature to synchronize with Maven projects.



## Component Documentation

The Log and File components are documented as well, just click on the links. Just return to this documentation later when you must use these components for real.

```
public OutputReportIncident reportIncident(InputReportIncident parameters) {
    String name = parameters.getGivenName() + " " + parameters.getFamilyName();

    // let Camel do something with the name
    sendToCamelLog(name);

    OutputReportIncident out = new OutputReportIncident();
    out.setCode("OK");
    return out;
}
```

Next is the Camel code. At first it looks like there are many code lines to do a simple task of logging the name - yes it is. But later you will in fact realize this is one of Camel's true power. Its concise API. Hint: The same code can be used for **any** component in Camel.

```
private void sendToCamelLog(String name) {
    try {
        // get the log component
        Component component = camel.getComponent("log");

        // create an endpoint and configure it.
        // Notice the URI parameters this is a common practice in Camel to configure
        // endpoints based on URI.
        // com.mycompany.part2 = the log category used. Will log at INFO level as
default
        Endpoint endpoint = component.createEndpoint("log:com.mycompany.part2");

        // create an Exchange that we want to send to the endpoint
        Exchange exchange = endpoint.createExchange();
        // set the in message payload (=body) with the name parameter
        exchange.getIn().setBody(name);

        // now we want to send the exchange to this endpoint and we then need a
producer
        // for this, so we create and start the producer.
        Producer producer = endpoint.createProducer();
        producer.start();
    }
}
```

```

        // process the exchange will send the exchange to the log component, that
will process
        // the exchange and yes log the payload
        producer.process(exchange);

        // stop the producer, we want to be nice and cleanup
        producer.stop();

    } catch (Exception e) {
        // we ignore any exceptions and just rethrow as runtime
        throw new RuntimeException(e);
    }
}

```

Okay there are code comments in the code block above that should explain what is happening. We run the code by invoking our unit test with `mvn test`, and we should get this log line:

```
INFO: Exchange[BodyType:String, Body:Claus Ibsen]
```

## WRITE TO FILE - EASY WITH THE SAME CODE STYLE

Okay that isn't too impressive, Camel can log 😊 Well I promised that the above code style can be used for **any** component, so let's store the payload in a file. We do this by adding the file component to the Camel context

```

// add the file component
camel.addComponent("file", new FileComponent());

```

And then we let camel write the payload to the file after we have logged, by creating a new method **sendToCamelFile**. We want to store the payload in filename with the incident id so we need this parameter also:

```

// let Camel do something with the name
sendToCamelLog(name);
sendToCamelFile(parameters.getIncidentId(), name);

```

And then the code that is 99% identical. We have change the URI configuration when we create the endpoint as we pass in configuration parameters to the file component.

And then we need to set the output filename and this is done by adding a special header to the exchange. That's the only difference:

```

private void sendToCamelFile(String incidentId, String name) {
    try {
        // get the file component
        Component component = camel.getComponent("file");
    }
}

```

```

        // create an endpoint and configure it.
        // Notice the URI parameters this is a common practice in Camel to configure
        // endpoints based on URI.
        // file://target instructs the base folder to output the files. We put in
the target folder
        // then its automatically cleaned by mvn clean
        Endpoint endpoint = component.createEndpoint("file://target");

        // create an Exchange that we want to send to the endpoint
        Exchange exchange = endpoint.createExchange();
        // set the in message payload (=body) with the name parameter
        exchange.getIn().setBody(name);

        // now a special header is set to instruct the file component what the
output filename
        // should be
        exchange.getIn().setHeader(FileComponent.HEADER_FILE_NAME, "incident-" +
incidentId + ".txt");

        // now we want to send the exchange to this endpoint and we then need a
producer
        // for this, so we create and start the producer.
        Producer producer = endpoint.createProducer();
        producer.start();
        // process the exchange will send the exchange to the file component, that
will process
        // the exchange and yes write the payload to the given filename
        producer.process(exchange);

        // stop the producer, we want to be nice and cleanup
        producer.stop();
    } catch (Exception e) {
        // we ignore any exceptions and just rethrow as runtime
        throw new RuntimeException(e);
    }
}

```

After running our unit test again with `mvn test` we have a output file in the target folder:

```

D:\demo\part-two>type target\incident-123.txt
Claus Ibsen

```

## FULLY JAVA BASED CONFIGURATION OF ENDPOINTS

In the file example above the configuration was URI based. What if you want 100% java setter based style, well this is of course also possible. We just need to cast to the component specific endpoint and then we have all the setters available:

```

// create the file endpoint, we cast to FileEndpoint because then we can do
// 100% java setter based configuration instead of the URI sting based
// must pass in an empty string, or part of the URI configuration if
wanted
        FileEndpoint endpoint = (FileEndpoint)component.createEndpoint("");

```



```
endpoint.setFile(new File("target/subfolder"));
endpoint.setAutoCreate(true);
```

That's it. Now we have used the setters to configure the `FileEndpoint` that it should store the file in the folder `target/subfolder`. Of course Camel now stores the file in the subfolder.

```
D:\demo\part-two>type target\subfolder\incident-123.txt
Claus Ibsen
```

## LESSONS LEARNED

Okay I wanted to demonstrate how you can be in 100% control of the configuration and usage of Camel based on plain Java code with no hidden magic or special **XML** or other configuration files. Just add the `camel-core.jar` and you are ready to go.

You must have noticed that the code for sending a message to a given endpoint is the same for both the **log** and **file**, in fact **any** Camel endpoint. You as the client shouldn't bother with component specific code such as file stuff for file components, jms stuff for JMS messaging etc. This is what the Message Endpoint EIP pattern is all about and Camel solves this very very nice - a key pattern in Camel.

## REDUCING CODE LINES

Now that you have been introduced to Camel and one of its masterpiece patterns solved elegantly with the Message Endpoint its time to give productive and show a solution in fewer code lines, in fact we can get it down to 5, 4, 3, 2 .. yes only **1 line of code**.

The key is the **ProducerTemplate** that is a Spring'ish `xxxTemplate` based producer. Meaning that it has methods to send messages to any Camel endpoints. First of all we need to get hold of such a template and this is done from the `CamelContext`

```
private ProducerTemplate template;

public ReportIncidentEndpointImpl() throws Exception {
    ...

    // get the ProducerTemplate thst is a Spring'ish xxxTemplate based producer
for very
    // easy sending exchanges to Camel.
    template = camel.createProducerTemplate();

    // start Camel
    camel.start();
}
```

Now we can use **template** for sending payloads to any endpoint in Camel. So all the logging gabble can be reduced to:

```
template.sendBody("log:com.mycompany.part2.easy", name);
```

And the same goes for the file, but we must also send the header to instruct what the output filename should be:

```
String filename = "easy-incident-" + incidentId + ".txt";
template.sendBodyAndHeader("file://target/subfolder", name,
FileComponent.HEADER_FILE_NAME, filename);
```

## REDUCING EVEN MORE CODE LINES

Well we got the Camel code down to 1-2 lines for sending the message to the component that does all the heavy work of wring the message to a file etc. But we still got 5 lines to initialize Camel.

```
camel = new DefaultCamelContext();
camel.addComponent("log", new LogComponent());
camel.addComponent("file", new FileComponent());
template = camel.createProducerTemplate();
camel.start();
```

This can also be reduced. All the standard components in Camel is auto discovered on-the-fly so we can remove these code lines and we are down to 3 lines.

Okay back to the 3 code lines:

```
camel = new DefaultCamelContext();
template = camel.createProducerTemplate();
camel.start();
```

Later will we see how we can reduce this to ... in fact 0 java code lines. But the 3 lines will do for now.

## MESSAGE TRANSLATION

Okay lets head back to the over goal of the integration. Looking at the EIP diagrams at the introduction page we need to be able to translate the incoming webservice to an email. Doing so we need to create the email body. When doing the message translation we could put up our sleeves and do it manually in pure java with a StringBuilder such as:

```
private String createMailBody(InputReportIncident parameters) {
    StringBuilder sb = new StringBuilder();
    sb.append("Incident ").append(parameters.getIncidentId());
    sb.append(" has been reported on the ").append(parameters.getIncidentDate());
    sb.append(" by ").append(parameters.getGivenName());
    sb.append(" ").append(parameters.getFamilyName());

    // and the rest of the mail body with more appends to the string builder

    return sb.toString();
}
```



## Component auto discovery

When an endpoint is requested with a scheme that Camel hasn't seen before it will try to look for it in the classpath. It will do so by looking for special Camel component marker files that reside in the folder `META-INF/services/org/apache/camel/component`. If there are files in this folder it will read them as the filename is the **scheme** part of the URL. For instance the **log** component is defined in this file `META-INF/services/org/apache/camel/component/log` and its content is:

```
class=org.apache.camel.component.log.LogComponent
```

The class property defines the component implementation.

**Tip:** End-users can create their 3rd party components using the same technique and have them been auto discovered on-the-fly.

But as always it is a hardcoded template for the mail body and the code gets kinda ugly if the mail message has to be a bit more advanced. But of course it just works out-of-the-box with just classes already in the JDK.

Lets use a template language instead such as Apache Velocity. As Camel have a component for Velocity integration we will use this component. Looking at the Component List overview we can see that camel-velocity component uses the artifactId **camel-velocity** so therefore we need to add this to the **pom.xml**

```
<dependency>
  <groupId>org.apache.camel</groupId>
  <artifactId>camel-velocity</artifactId>
  <version>${camel-version}</version>
</dependency>
```

And now we have a Spring conflict as Apache CXF is dependent on Spring 2.0.8 and camel-velocity is dependent on Spring 2.5.5. To remedy this we could wrestle with the **pom.xml** with excludes settings in the dependencies or just bring in another dependency **camel-spring**:

```
<dependency>
  <groupId>org.apache.camel</groupId>
  <artifactId>camel-spring</artifactId>
  <version>${camel-version}</version>
</dependency>
```

In fact camel-spring is such a vital part of Camel that you will end up using it in nearly all situations - we will look into how well Camel is seamless integration with Spring in part 3. For now its just another dependency.

We create the mail body with the Velocity template and create the file `src/main/resources/MailBody.vm`. The content in the **MailBody.vm** file is:

```
Incident $body.incidentId has been reported on the $body.incidentDate by
$body.givenName $body.familyName.
```

```
The person can be contact by:
```

```
- email: $body.email
- phone: $body.phone
```

```
Summary: $body.summary
```

```
Details:
```

```
$body.details
```

```
This is an auto generated email. You can not reply.
```

Letting Camel creating the mail body and storing it as a file is as easy as the following 3 code lines:

```
private void generateEmailBodyAndStoreAsFile(InputReportIncident parameters) {
    // generate the mail body using velocity template
    // notice that we just pass in our POJO (= InputReportIncident) that we
    // got from Apache CXF to Velocity.
    Object response = template.sendBody("velocity:MailBody.vm", parameters);
    // Note: the response is a String and can be cast to String if needed

    // store the mail in a file
    String filename = "mail-incident-" + parameters.getIncidentId() + ".txt";
    template.sendBodyAndHeader("file://target/subfolder", response,
    FileComponent.HEADER_FILE_NAME, filename);
}
```

What is impressive is that we can just pass in our POJO object we got from Apache CXF to Velocity and it will be able to generate the mail body with this object in its context. Thus we don't need to prepare **anything** before we let Velocity loose and generate our mail body. Notice that the **template** method returns a object with out response. This object contains the mail body as a String object. We can cast to String if needed.

If we run our unit test with `mvn test` we can in fact see that Camel has produced the file and we can type its content:

```
D:\demo\part-two>type target\subfolder\mail-incident-123.txt
Incident 123 has been reported on the 2008-07-16 by Claus Ibsen.
```

```
The person can be contact by:
```

```
- email: davsclaus@apache.org
- phone: +45 2962 7576
```

```
Summary: bla bla
```

```
Details:
```

```
more bla bla
```

```
This is an auto generated email. You can not reply.
```

## FIRST PART OF THE SOLUTION

What we have seen here is actually what it takes to build the first part of the integration flow. Receiving a request from a webservice, transform it to a mail body and store it to a file, and return an OK response to the webservice. All possible within 10 lines of code. So lets wrap it up here is what it takes:

```
/**
 * The webservice we have implemented.
 */
public class ReportIncidentEndpointImpl implements ReportIncidentEndpoint {

    private CamelContext camel;
    private ProducerTemplate template;

    public ReportIncidentEndpointImpl() throws Exception {
        // create the camel context that is the "heart" of Camel
        camel = new DefaultCamelContext();

        // get the ProducerTemplate thst is a Spring'ish xxxTemplate based producer
for very
        // easy sending exchanges to Camel.
        template = camel.createProducerTemplate();

        // start Camel
        camel.start();
    }

    public OutputReportIncident reportIncident(InputReportIncident parameters) {
        // transform the request into a mail body
        Object mailBody = template.sendBody("velocity:MailBody.vm", parameters);

        // store the mail body in a file
        String filename = "mail-incident-" + parameters.getIncidentId() + ".txt";
        template.sendBodyAndHeader("file://target/subfolder", mailBody,
FileComponent.HEADER_FILE_NAME, filename);

        // return an OK reply
        OutputReportIncident out = new OutputReportIncident();
        out.setCode("OK");
        return out;
    }
}
```

Okay I missed by one, its in fact only **9 lines of java code and 2 fields**.

## END OF PART 2

I know this is a bit different introduction to Camel to how you can start using it in your projects just as a plain java .jar framework that isn't invasive at all. I took you through the coding parts that requires 6 - 10 lines to send a message to an endpoint, but its important to

show the Message Endpoint EIP pattern in action and how its implemented in Camel. Yes of course Camel also has to one liners that you can use, and will use in your projects for sending messages to endpoints. This part has been about good old plain java, nothing fancy with Spring, XML files, auto discovery, OGSi or other new technologies. I wanted to demonstrate the basic building blocks in Camel and how its setup in pure god old fashioned Java. There are plenty of eye catcher examples with one liners that does more than you can imagine - we will come there in the later parts.

Okay part 3 is about building the last pieces of the solution and now it gets interesting since we have to wrestle with the event driven consumer.

Brew a cup of coffee, tug the kids and kiss the wife, for now we will have us some fun with the Camel. See you in part 3.

## RESOURCES

	Name	Size	Creator	Date	Comment
.	 part-two.zip	17 kb	Claus Ibsen	Jul 19, 2008	

## LINKS

- Introduction
- Part 1
- Part 2
- Part 3
- Part 4
- Part 5

## PART 3

## RECAP

Lets just recap on the solution we have now:

```
public class ReportIncidentEndpointImpl implements ReportIncidentEndpoint {  
  
    private CamelContext camel;  
    private ProducerTemplate template;  
  
    public ReportIncidentEndpointImpl() throws Exception {
```

```

        // create the camel context that is the "heart" of Camel
        camel = new DefaultCamelContext();

        // get the ProducerTemplate thst is a Spring'ish xxxTemplate based producer
for very
        // easy sending exchanges to Camel.
        template = camel.createProducerTemplate();

        // start Camel
        camel.start();
    }

    /**
     * This is the last solution displayed that is the most simple
     */
    public OutputReportIncident reportIncident(InputReportIncident parameters) {
        // transform the request into a mail body
        Object mailBody = template.sendBody("velocity:MailBody.vm", parameters);

        // store the mail body in a file
        String filename = "mail-incident-" + parameters.getIncidentId() + ".txt";
        template.sendBodyAndHeader("file://target/subfolder", mailBody,
FileComponent.HEADER_FILE_NAME, filename);

        // return an OK reply
        OutputReportIncident out = new OutputReportIncident();
        out.setCode("OK");
        return out;
    }
}

```

This completes the first part of the solution: receiving the message using webservice, transform it to a mail body and store it as a text file.

What is missing is the last part that polls the text files and send them as emails. Here is where some fun starts, as this requires usage of the Event Driven Consumer EIP pattern to react when new files arrives. So lets see how we can do this in Camel. There is a saying: Many roads lead to Rome, and that is also true for Camel - there are many ways to do it in Camel.

## ADDING THE EVENT DRIVEN CONSUMER

We want to add the consumer to our integration that listen for new files, we do this by creating a private method where the consumer code lives. We must register our consumer in Camel before its started so we need to add, and there fore we call the method **addMailSenderConsumer** in the constructor below:

```

public ReportIncidentEndpointImpl() throws Exception {
    // create the camel context that is the "heart" of Camel
    camel = new DefaultCamelContext();

    // get the ProducerTemplate thst is a Spring'ish xxxTemplate based producer
for very

```

```

        // easy sending exchanges to Camel.
        template = camel.createProducerTemplate();

        // add the event driven consumer that will listen for mail files and process
then
        addMailSendConsumer();

        // start Camel
        camel.start();
    }

```

The consumer needs to be consuming from an endpoint so we grab the endpoint from Camel we want to consume. It's `file://target/subfolder`. Don't be fooled this endpoint doesn't have to 100% identical to the producer, i.e. the endpoint we used in the previous part to create and store the files. We could change the URL to include some options, and to make it more clear that it's possible we setup a delay value to 10 seconds, and the first poll starts after 2 seconds. This is done by adding

`?consumer.delay=10000&consumer.initialDelay=2000` to the URL.

When we have the endpoint we can create the consumer (just as in part I where we created a producer). Creating the consumer requires a Processor where we implement the java code what should happen when a message arrives. To get the mail body as a String object we can use the **getBody** method where we can provide the type we want in return.

Sending the email is still left to be implemented, we will do this later. And finally we must remember to start the consumer otherwise its not active and won't listen for new files.

```

private void addMailSendConsumer() throws Exception {
    // Grab the endpoint where we should consume. Option - the first poll starts
after 2 seconds
    Endpoint endpoint = camel.getEndpoint("file://target/
subfolder?consumer.initialDelay=2000");

    // create the event driven consumer
    // the Processor is the code what should happen when there is an event
    // (think it as the onMessage method)
    Consumer consumer = endpoint.createConsumer(new Processor() {
        public void process(Exchange exchange) throws Exception {
            // get the mail body as a String
            String mailBody = exchange.getIn().getBody(String.class);

            // okay now we are read to send it as an email
            System.out.println("Sending email..." + mailBody);
        }
    });

    // star the consumer, it will listen for files
    consumer.start();
}

```

Before we test it we need to be aware that our unit test is only catering for the first part of the solution, receiving the message with webservice, transforming it using Velocity and then storing it as a file - it doesn't test the Event Driven Consumer we just added. As we are eager to see it





## URL Configuration

The URL configuration in Camel endpoints is just like regular URL we know from the Internet. You use ? and & to set the options.



## Camel Type Converter

Why don't we just cast it as we always do in Java? Well the biggest advantage when you provide the type as a parameter you tell Camel what type you want and Camel can automatically convert it for you, using its flexible Type Converter mechanism. This is a great advantage, and you should try to use this instead of regular type casting.

in action, we just do a common trick adding some sleep in our unit test, that gives our Event Driven Consumer time to react and print to System.out. We will later refine the test:

```
public void testRendportIncident() throws Exception {
    ...

    OutputReportIncident out = client.reportIncident(input);
    assertEquals("Response code is wrong", "OK", out.getCode());

    // give the event driven consumer time to react
    Thread.sleep(10 * 1000);
}
```

We run the test with `mvn clean test` and have eyes fixed on the console output. During all the output in the console, we see that our consumer has been triggered, as we want.

```
2008-07-19 12:09:24,140 [mponent@1f12c4e] DEBUG FileProcessStrategySupport - Locking
the file: target\subfolder\mail-incident-123.txt ...
Sending email...Incident 123 has been reported on the 2008-07-16 by Claus Ibsen.

The person can be contact by:
- email: davsclaus@apache.org
- phone: +45 2962 7576

Summary: bla bla

Details:
more bla bla

This is an auto generated email. You can not reply.
2008-07-19 12:09:24,156 [mponent@1f12c4e] DEBUG FileConsumer - Done processing file:
target\subfolder\mail-incident-123.txt. Status is: OK
```

## SENDING THE EMAIL

Sending the email requires access to a SMTP mail server, but the implementation code is very simple:

```
private void sendEmail(String body) {
    // send the email to your mail server
    String url =
"smtplib://someone@localhost?password=secret&to=incident@mycompany.com";
    template.sendBodyAndHeader(url, body, "subject", "New incident reported");
}
```

And just invoke the method from our consumer:

```
// okay now we are read to send it as an email
System.out.println("Sending email...");
sendEmail(mailBody);
System.out.println("Email sent");
```

## UNIT TESTING MAIL

For unit testing the consumer part we will use a mock mail framework, so we add this to our **pom.xml**:

```
<!-- unit testing mail using mock -->
<dependency>
  <groupId>org.jvnet.mock-javamail</groupId>
  <artifactId>mock-javamail</artifactId>
  <version>1.7</version>
  <scope>test</scope>
</dependency>
```

Then we prepare our integration to run with or without the consumer enabled. We do this to separate the route into the two parts:

- receive the webservice, transform and save mail file and return OK as repose
- the consumer that listen for mail files and send them as emails

So we change the constructor code a bit:

```
public ReportIncidentEndpointImpl() throws Exception {
    init(true);
}

public ReportIncidentEndpointImpl(boolean enableConsumer) throws Exception {
    init(enableConsumer);
}

private void init(boolean enableConsumer) throws Exception {
    // create the camel context that is the "heart" of Camel
    camel = new DefaultCamelContext();

    // get the ProducerTemplate thst is a Spring'ish xxxTemplate based producer
for very
    // easy sending exchanges to Camel.
```

```

        template = camel.createProducerTemplate();

        // add the event driven consumer that will listen for mail files and process
them
        if (enableConsumer) {
            addMailSendConsumer();
        }

        // start Camel
        camel.start();
    }

```

Then remember to change the **ReportIncidentEndpointTest** to pass in **false** in the **ReportIncidentEndpointImpl** constructor.

And as always run `mvn clean test` to be sure that the latest code changes works.

## ADDING NEW UNIT TEST

We are now ready to add a new unit test that tests the consumer part so we create a new test class that has the following code structure:

```

/**
 * Plain JUnit test of our consumer.
 */
public class ReportIncidentConsumerTest extends TestCase {

    private ReportIncidentEndpointImpl endpoint;

    public void testConsumer() throws Exception {
        // we run this unit test with the consumer, hence the true parameter
        endpoint = new ReportIncidentEndpointImpl(true);
    }
}

```

As we want to test the consumer that it can listen for files, read the file content and send it as an email to our mailbox we will test it by asserting that we receive 1 mail in our mailbox and that the mail is the one we expect. To do so we need to grab the mailbox with the mockmail API. This is done as simple as:

```

public void testConsumer() throws Exception {
    // we run this unit test with the consumer, hence the true parameter
    endpoint = new ReportIncidentEndpointImpl(true);

    // get the mailbox
    Mailbox box = Mailbox.get("incident@mycompany.com");
    assertEquals("Should not have mails", 0, box.size());
}

```

How do we trigger the consumer? Well by creating a file in the folder it listen for. So we could use plain `java.io.File` API to create the file, but wait isn't there an smarter solution? ... yes Camel of course. Camel can do amazing stuff in one liner codes with its `ProducerTemplate`, so we

need to get a hold of this baby. We expose this template in our ReportIncidentEndpointImpl but adding this getter:

```
protected ProducerTemplate getTemplate() {
    return template;
}
```

Then we can use the template to create the file in **one code line**:

```
// drop a file in the folder that the consumer listen
// here is a trick to reuse Camel! so we get the producer template and just
// fire a message that will create the file for us
endpoint.getTemplate().sendBodyAndHeader("file://target/
subfolder?append=false", "Hello World",
    FileComponent.HEADER_FILE_NAME, "mail-incident-test.txt");
```

Then we just need to wait a little for the consumer to kick in and do its work and then we should assert that we got the new mail. Easy as just:

```
// let the consumer have time to run
Thread.sleep(3 * 1000);

// get the mock mailbox and check if we got mail ;)
assertEquals("Should have got 1 mail", 1, box.size());
assertEquals("Subject wrong", "New incident reported",
    box.get(0).getSubject());
assertEquals("Mail body wrong", "Hello World", box.get(0).getContent());
}
```

The final class for the unit test is:

```
/**
 * Plain JUnit test of our consumer.
 */
public class ReportIncidentConsumerTest extends TestCase {

    private ReportIncidentEndpointImpl endpoint;

    public void testConsumer() throws Exception {
        // we run this unit test with the consumer, hence the true parameter
        endpoint = new ReportIncidentEndpointImpl(true);

        // get the mailbox
        Mailbox box = Mailbox.get("incident@mycompany.com");
        assertEquals("Should not have mails", 0, box.size());

        // drop a file in the folder that the consumer listen
        // here is a trick to reuse Camel! so we get the producer template and just
        // fire a message that will create the file for us
        endpoint.getTemplate().sendBodyAndHeader("file://target/
subfolder?append=false", "Hello World",
            FileComponent.HEADER_FILE_NAME, "mail-incident-test.txt");

        // let the consumer have time to run
        Thread.sleep(3 * 1000);
    }
}
```

```

    // get the mock mailbox and check if we got mail ;)
    assertEquals("Should have got 1 mail", 1, box.size());
    assertEquals("Subject wrong", "New incident reported",
box.get(0).getSubject());
    assertEquals("Mail body wrong", "Hello World", box.get(0).getContent());
}
}

```

## END OF PART 3

Okay we have reached the end of part 3. For now we have only scratched the surface of what Camel is and what it can do. We have introduced Camel into our integration piece by piece and slowly added more and more along the way. And the most important is: **you as the developer never lost control**. We hit a sweet spot in the webservice implementation where we could write our java code. Adding Camel to the mix is just to use it as a regular java code, nothing magic. We were in control of the flow, we decided when it was time to translate the input to a mail body, we decided when the content should be written to a file. This is very important to not lose control, that the bigger and heavier frameworks tend to do. No names mentioned, but boy do developers from time to time dislike these elephants. And Camel is **no elephant**.

I suggest you download the samples from part 1 to 3 and try them out. It is great basic knowledge to have in mind when we look at some of the features where Camel really excel - **the routing domain language**.

From part 1 to 3 we touched concepts such as::

- Endpoint
- URI configuration
- Consumer
- Producer
- Event Driven Consumer
- Component
- CamelContext
- ProducerTemplate
- Processor
- Type Converter

## RESOURCES

	Name	Size	Creator	Date	Comment
•	 part-three.zip	18 kb	Claus Ibsen	Jul 20, 2008	

## LINKS

- Introduction
- Part 1
- Part 2
- Part 3
- Part 4
- Part 5

## PART 4

### INTRODUCTION

This section is about regular Camel. The examples presented here in this section is much more in common of all the examples we have in the Camel documentation.

### ROUTING

Camel is particular strong as a light-weight and agile **routing** and **mediation** framework. In this part we will introduce the **routing** concept and how we can introduce this into our solution.

Looking back at the figure from the Introduction page we want to implement this routing. Camel has support for expressing this routing logic using Java as a DSL (Domain Specific Language). In fact Camel also has DSL for XML and Scala. In this part we use the Java DSL as its the most powerful and all developers know Java. Later we will introduce the XML version that is very well integrated with Spring.

Before we jump into it, we want to state that this tutorial is about **Developers not loosing control**. In my humble experience one of the key fears of developers is that they are forced into a tool/framework where they loose control and/or power, and the possible is now impossible. So in this part we stay clear with this vision and our starting point is as follows:

- We have generated the webservice source code using the CXF wsdl2java generator and we have our ReportIncidentEndpointImpl.java file where we as a Developer feels home and have the power.

So the starting point is:

```
/**
 * The webservice we have implemented.
 */
public class ReportIncidentEndpointImpl implements ReportIncidentEndpoint {
```



If you have been reading the previous 3 parts then, this quote applies:

you must unlearn what you have learned  
*Master Yoda, Star Wars IV*

So we start all over again! 😞

```
/**
 * This is the last solution displayed that is the most simple
 */
public OutputReportIncident reportIncident(InputReportIncident parameters) {
    // WE ARE HERE !!!
    return null;
}
}
```

Yes we have a simple plain Java class where we have the implementation of the webservice. The cursor is blinking at the WE ARE HERE block and this is where we feel home. More or less any Java Developers have implemented webservices using a stack such as: Apache AXIS, Apache CXF or some other quite popular framework. They all allow the developer to be in control and implement the code logic as plain Java code. Camel of course doesn't enforce this to be any different. Okay the boss told us to implement the solution from the figure in the Introduction page and we are now ready to code.

## RouteBuilder

**RouteBuilder** is the hearth in Camel of the Java DSL routing. This class does all the heavy lifting of supporting EIP verbs for end-users to express the routing. It does take a little while to get settled and used to, but when you have worked with it for a while you will enjoy its power and realize it is in fact a little language inside Java itself. Camel is the **only** integration framework we are aware of that has Java DSL, all the others are usually **only** XML based.

As an end-user you usually use the **RouteBuilder** as of follows:

- create your own Route class that extends **RouteBuilder**
- implement your routing DSL in the **configure** method

So we create a new class ReportIncidentRoutes and implement the first part of the routing:

```
import org.apache.camel.builder.RouteBuilder;

public class ReportIncidentRoutes extends RouteBuilder {

    public void configure() throws Exception {
        // direct:start is a internal queue to kick-start the routing in our example
        // we use this as the starting point where you can send messages to
        direct:start
    }
}
```

```

    from("direct:start")
      // to is the destination we send the message to our velocity endpoint
      // where we transform the mail body
      .to("velocity:MailBody.vm");
  }
}

```

What to notice here is the **configure** method. Here is where all the action is. Here we have the Java DSL language, that is expressed using the **fluent builder syntax** that is also known from Hibernate when you build the dynamic queries etc. What you do is that you can stack methods separating with the dot.

In the example above we have a very common routing, that can be distilled from pseudo verbs to actual code with:

- from A to B
- From Endpoint A To Endpoint B
- from("endpointA").to("endpointB")
- from("direct:start").to("velocity:MailBody.vm");

**from("direct:start")** is the consumer that is kick-starting our routing flow. It will wait for messages to arrive on the direct queue and then dispatch the message.

**to("velocity:MailBody.vm")** is the producer that will receive a message and let Velocity generate the mail body response.

So what we have implemented so far with our ReportIncidentRoutes RouteBuilder is this part of the picture:

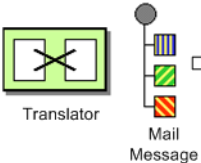

### Adding the RouteBuilder

Now we have our RouteBuilder we need to add/connect it to our CamelContext that is the hearth of Camel. So turning back to our webservice implementation class ReportIncidentEndpointImpl we add this constructor to the code, to create the CamelContext and add the routes from our route builder and finally to start it.

```

private CamelContext context;

public ReportIncidentEndpointImpl() throws Exception {
    // create the context
    context = new DefaultCamelContext();

    // append the routes to the context
    context.addRoutes(new ReportIncidentRoutes());

    // at the end start the camel context
}

```



```

    context.start();
}

```

Okay how do you use the routes then? Well its just as before we use a `ProducerTemplate` to send messages to Endpoints, so we just send to the **direct:start** endpoint and it will take it from there.

So we implement the logic in our webservice operation:

```

/**
 * This is the last solution displayed that is the most simple
 */
public OutputReportIncident reportIncident(InputReportIncident parameters) {
    Object mailBody = context.createProducerTemplate().sendBody("direct:start",
parameters);
    System.out.println("Body: " + mailBody);

    // return an OK reply
    OutputReportIncident out = new OutputReportIncident();
    out.setCode("OK");
    return out;
}

```

Notice that we get the producer template using the **createProducerTemplate** method on the `CamelContext`. Then we send the input parameters to the **direct:start** endpoint and it will route it **to** the velocity endpoint that will generate the mail body. Since we use **direct** as the consumer endpoint (=from) and its a **synchronous** exchange we will get the response back from the route. And the response is of course the output from the velocity endpoint.

We have now completed this part of the picture:

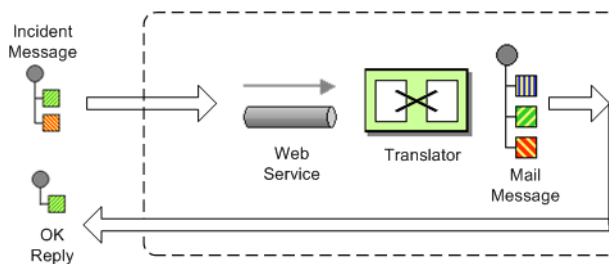

## UNIT TESTING

Now is the time we would like to unit test what we got now. So we call for camel and its great test kit. For this to work we need to add it to the pom.xml

```

<dependency>
    <groupId>org.apache.camel</groupId>
    <artifactId>camel-core</artifactId>
    <version>1.4.0</version>
    <scope>test</scope>
    <type>test-jar</type>
</dependency>

```

After adding it to the pom.xml you should refresh your Java Editor so it picks up the new jar. Then we are ready to create our unit test class.

We create this unit test skeleton, where we **extend** this class ContextTestSupport

```
package org.apache.camel.example.reportincident;

import org.apache.camel.ContextTestSupport;
import org.apache.camel.builder.RouteBuilder;

/**
 * Unit test of our routes
 */
public class ReportIncidentRoutesTest extends ContextTestSupport {

}
```

ContextTestSupport is a supporting unit test class for much easier unit testing with Apache Camel. The class is extending JUnit TestCase itself so you get all its glory. What we need to do now is to somehow tell this unit test class that it should use our route builder as this is the one we gonna test. So we do this by implementing the createRouteBuilder method.

```
@Override
protected RouteBuilder createRouteBuilder() throws Exception {
    return new ReportIncidentRoutes();
}
```

That is easy just return an instance of our route builder and this unit test will use our routes. We then code our unit test method that sends a message to the route and assert that it is transformed to the mail body using the Velocity template.

```
public void testTransformMailBody() throws Exception {
    // create a dummy input with some input data
    InputReportIncident parameters = createInput();

    // send the message (using the sendBody method that takes a parameters as the
    // input body)
    // to "direct:start" that kick-starts the route
    // the response is returned as the out object, and its also the body of the
    // response
    Object out = context.createProducerTemplate().sendBody("direct:start",
        parameters);

    // convert the response to a string using camel converters. However we could
    // also have casted it to
    // a string directly but using the type converters ensure that Camel can
    // convert it if it wasn't a string
    // in the first place. The type converters in Camel is really powerful and you
    // will later learn to
    // appreciate them and wonder why its not build in Java out-of-the-box
    String body = context.getTypeConverter().convertTo(String.class, out);

    // do some simple assertions of the mail body
    assertTrue(body.startsWith("Incident 123 has been reported on the 2008-07-16
```



It is quite common in Camel itself to unit test using routes defined as an anonymous inner class, such as illustrated below:

```
protected RouteBuilder createRouteBuilder() throws Exception {
    return new RouteBuilder() {
        public void configure() throws Exception {
            // TODO: Add your routes here, such as:
            from("jms:queue:inbox").to("file://target/out");
        }
    };
}
```

The same technique is of course also possible for end-users of Camel to create parts of your routes and test them separately in many test classes. However in this tutorial we test the real route that is to be used for production, so we just return an instance of the real one.

```
by Claus Ibsen."));
}

/**
 * Creates a dummy request to be used for input
 */
protected InputReportIncident createInput() {
    InputReportIncident input = new InputReportIncident();
    input.setIncidentId("123");
    input.setIncidentDate("2008-07-16");
    input.setGivenName("Claus");
    input.setFamilyName("Ibsen");
    input.setSummary("bla bla");
    input.setDetails("more bla bla");
    input.setEmail("davsclaus@apache.org");
    input.setPhone("+45 2962 7576");
    return input;
}
```

## ADDING THE FILE BACKUP

The next piece of puzzle that is missing is to store the mail body as a backup file. So we turn back to our route and the EIP patterns. We use the Pipes and Filters pattern here to chain the routing as:

```
public void configure() throws Exception {
    from("direct:start")
        .to("velocity:MailBody.vm")
        // using pipes-and-filters we send the output from the previous to the next
        .to("file://target/subfolder");
}
```

Notice that we just add a 2nd **.to** on the newline. Camel will default use the Pipes and Filters pattern here when there are multi endpoints chained liked this. We could have used the **pipeline** verb to let out stand out that its the Pipes and Filters pattern such as:

```
from("direct:start")
    // using pipes-and-filters we send the output from the previous to the next
    .pipeline("velocity:MailBody.vm", "file://target/subfolder");
```

But most people are using the multi **.to** style instead.

We re-run out unit test and verifies that it still passes:

```
Running org.apache.camel.example.reportincident.ReportIncidentRoutesTest
Tests run: 1, Failures: 0, Errors: 0, Skipped: 0, Time elapsed: 1.157 sec
```

But hey we have added the file *producer* endpoint and thus a file should also be created as the backup file. If we look in the `target/subfolder` we can see that something happened. On my humble laptop it created this folder: **target\subfolder\ID-claus-acer**. So the file producer create a sub folder named `ID-claus-acer` what is this? Well Camel auto generates an unique filename based on the unique message id if not given instructions to use a fixed filename. In fact it creates another sub folder and name the file as: `target\subfolder\ID-claus-acer\3750-1219148558921\1-0` where `1-0` is the file with the mail body. What we want is to use our own filename instead of this auto generated filename. This is archived by adding a header to the message with the filename to use. So we need to add this to our route and compute the filename based on the message content.

## Setting the filename

For starters we show the simple solution and build from there. We start by setting a constant filename, just to verify that we are on the right path, to instruct the file producer what filename to use. The file producer uses a special header `FileComponent.HEADER_FILE_NAME` to set the filename.

What we do is to send the header when we "kick-start" the routing as the header will be propagated from the direct queue to the file producer. What we need to do is to use the `ProducerTemplate.sendBodyAndHeader` method that takes **both** a body and a header. So we change out webservice code to include the filename also:

```
public OutputReportIncident reportIncident(InputReportIncident parameters) {
    // create the producer template to use for sending messages
    ProducerTemplate producer = context.createProducerTemplate();
    // send the body and the filename defined with the special header key
    Object mailBody = producer.sendBodyAndHeader("direct:start", parameters,
FileComponent.HEADER_FILE_NAME, "incident.txt");
    System.out.println("Body:" + mailBody);

    // return an OK reply
    OutputReportIncident out = new OutputReportIncident();
    out.setCode("OK");
    return out;
}
```

However we could also have used the route builder itself to configure the constant filename as shown below:

```
public void configure() throws Exception {
    from("direct:start")
        .to("velocity:MailBody.vm")
        // set the filename to a constant before the file producer receives the
message
        .setHeader(FileComponent.HEADER_FILE_NAME, constant("incident.txt"))
        .to("file://target/subfolder");
}
```

But Camel can be smarter and we want to dynamic set the filename based on some of the input parameters, how can we do this?

Well the obvious solution is to compute and set the filename from the webservice implementation, but then the webservice implementation has such logic and we want this decoupled, so we could create our own POJO bean that has a method to compute the filename. We could then instruct the routing to invoke this method to get the computed filename. This is a string feature in Camel, its Bean binding. So lets show how this can be done:

## Using Bean Language to compute the filename

First we create our plain java class that computes the filename, and it has 100% no dependencies to Camel what so ever.

```
/**
 * Plain java class to be used for filename generation based on the reported incident
 */
public class FilenameGenerator {

    public String generateFilename(InputReportIncident input) {
        // compute the filename
        return "incident-" + input.getIncidentId() + ".txt";
    }
}
```

The class is very simple and we could easily create unit tests for it to verify that it works as expected. So what we want now is to let Camel invoke this class and its generateFilename with the input parameters and use the output as the filename. Pheewww is this really possible out-of-the-box in Camel? Yes it is. So lets get on with the show. We have the code that computes the filename, we just need to call it from our route using the Bean Language:

```
public void configure() throws Exception {
    from("direct:start")
        // set the filename using the bean language and call the FilenameGenerator
class.
        // the 2nd null parameter is optional methodname, to be used to avoid
ambiguity.
        // if not provided Camel will try to figure out the best method to invoke,
as we
```

```

// only have one method this is very simple
.setHeader(FileComponent.HEADER_FILE_NAME,
BeanLanguage.bean(FilenameGenerator.class, null))
.to("velocity:MailBody.vm")
.to("file://target/subfolder");
}

```

Notice that we use the **bean** language where we supply the class with our bean to invoke. Camel will instantiate an instance of the class and invoke the suited method. For completeness and ease of code readability we add the method name as the 2nd parameter

```

.setHeader(FileComponent.HEADER_FILE_NAME, BeanLanguage.bean(FilenameGenerator.class,
"generateFilename"))

```

Then other developers can understand what the parameter is, instead of null.

Now we have a nice solution, but as a sidetrack I want to demonstrate the Camel has other languages out-of-the-box, and that scripting language is a first class citizen in Camel where it etc. can be used in content based routing. However we want it to be used for the filename generation.

Whatever worked for you we have now implemented the backup of the data files:

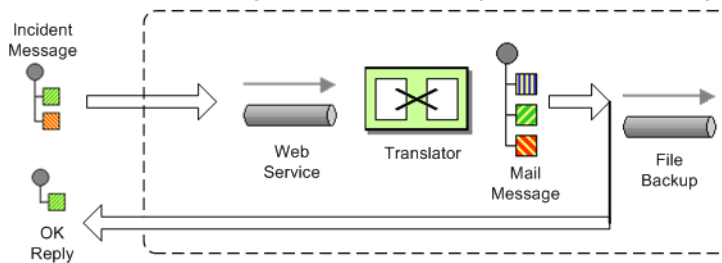

## SENDING THE EMAIL

What we need to do before the solution is completed is to actually send the email with the mail body we generated and stored as a file. In the previous part we did this with a File consumer, that we manually added to the CamelContext. We can do this quite easily with the routing.

```

import org.apache.camel.builder.RouteBuilder;

public class ReportIncidentRoutes extends RouteBuilder {

    public void configure() throws Exception {
        // first part from the webservice -> file backup
        from("direct:start")
        .setHeader(FileComponent.HEADER_FILE_NAME, bean(FilenameGenerator.class,
"generateFilename"))
        .to("velocity:MailBody.vm")
        .to("file://target/subfolder");

        // second part from the file backup -> send email
        from("file://target/subfolder")

```



## Using a script language to set the filename

We could do as in the previous parts where we send the computed filename as a message header when we "kick-start" the route. But we want to learn new stuff so we look for a different solution using some of Camels many Languages. As OGNL is a favorite language of mine (used by WebWork) so we pick this baby for a Camel ride. For starters we must add it to our pom.xml:

```
<dependency>
  <groupId>org.apache.camel</groupId>
  <artifactId>camel-ognl</artifactId>
  <version>${camel-version}</version>
</dependency>
```

And remember to refresh your editor so you got the new .jars.

We want to construct the filename based on this syntax: mail-incident-#ID#.txt where #ID# is the incident id from the input parameters. As OGNL is a language that can invoke methods on bean we can invoke the `getIncidentId()` on the message body and then concat it with the fixed pre and postfix strings.

In OGNL glory this is done as:

```
"mail-incident-" + request.body.incidentId + ".txt"
```

where `request.body.incidentId` computes to:

- **request** is the IN message. See the OGNL for other predefined objects available
- **body** is the body of the in message
- **incidentId** will invoke the `getIncidentId()` method on the body. The rest is just more or less regular plain code where we can concat strings.

Now we got the expression to dynamic compute the filename on the fly we need to set it on our route so we turn back to our route, where we can add the OGNL expression:

```
public void configure() throws Exception {
    from("direct:start")
        // we need to set the filename and uses OGNL for this
        .setHeader(FileComponent.HEADER_FILE_NAME,
            OgnExpression.ognl("'mail-incident-' + request.body.incidentId +
                '.txt'"))
        // using pipes-and-filters we send the output from the
        previous to the next
        .pipeline("velocity:MailBody.vm", "file://target/subfolder");
}
```

And since we are on Java 1.5 we can use the static import of **ognl** so we have:

```
import static org.apache.camel.language.ognl.OgnlExpression.ognl;
...
.setHeader(FileComponent.HEADER_FILE_NAME, ognl("'mail-incident-' +
request.body.incidentId + '.txt'"))
```

Notice the import static also applies for all the other languages, such as the Bean Language we used previously.

```
// set the subject of the email
.setHeader("subject", constant("new incident reported"))
// send the email
.to("smtp://someone@localhost?password=secret&to=incident@mycompany.com");
}
}
```

The last 3 lines of code does all this. It adds a file consumer **from("file://target/subfolder")**, sets the mail subject, and finally send it as an email.

The DSL is really powerful where you can express your routing integration logic. So we completed the last piece in the picture puzzle with just 3 lines of code.

We have now completed the integration:

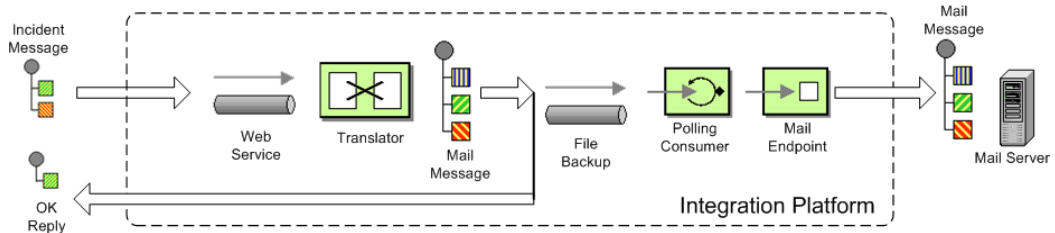

## CONCLUSION

We have just briefly touched the **routing** in Camel and shown how to implement them using the **fluent builder** syntax in Java. There is much more to the routing in Camel than shown here, but we are learning step by step. We continue in part 5. See you there.

## RESOURCES

Name	Size	Creator	Date	Comment
------	------	---------	------	---------





part-four.zip

11  
kb

Claus  
Ibsen

Aug  
25,  
2008

---

## LINKS

- [Introduction](#)
- [Part 1](#)
- [Part 2](#)
- [Part 3](#)
- [Part 4](#)
- [Part 5](#)

## BETTER JMS TRANSPORT FOR CXF WEBSERVICE USING APACHE CAMEL

Configuring JMS in Apache CXF is possible but not really easy or nice. This article shows how to use Apache Camel to provide a better JMS Transport for CXF.

You can find the original announcement for this Tutorial and some additional info on Christian Schneider's Blog

### Why not simply use JMS Features of Apache CXF

JMS configuration in Apache CXF is possible but the configuration is not very flexible and quite error prone. In CXF you have to configure a JMSConduit or a JMSDestination for each webservice. The connection between Conduit and the Service proxy is the endpoint name which looks like "{http://service.test}HelloWorldPort.jms-conduit". As this name is never explicitly configured elsewhere it is quite probable that you misspell the name. If this happens then the JMS Transport just does not work. There is no good error reporting to show you what you did wrong. The next thing is that you have to use JNDI for the connectionFactory and the queue name. This is something that beginners with JMS have many problems with.

### Why is using Apache Camel better in the JMS Transport layer

In Apache Camel you can simply reference the ConnectionFactory as a Spring bean. This means you can either define it directly in a Spring bean what is the ideal way to start or you can use Spring's JNDI binding to retrieve it from your application server for production use.

The next nice thing is that you can configure all JMS options like receive timeout or username / password in a central location, the JMSComponent and then share this config for several services. On the other hand you can easily configure different JMS providers.

## So how to connect Apache Camel and CXF

The best way to connect Camel and CXF is using the Camel transport for CXF. This is a camel module that registers with cxf as a new transport. It is quite easy to configure.

```
<bean class="org.apache.camel.component.cxf.transport.CamelTransportFactory">
  <property name="bus" ref="cxf" />
  <property name="camelContext" ref="camelContext" />
  <property name="transportIds">
    <list>
      <value>http://cxf.apache.org/transport/camel</value>
    </list>
  </property>
</bean>
```

This bean registers with CXF and provides a new transport prefix camel:// that can be used in CXF address configurations. The bean references a bean cxf which will be already present in your config. The other reference is a camel context. We will later define this bean to provide the routing config.

## How is JMS configured in Camel

In camel you need two things to configure JMS. A ConnectionFactory and a JMSComponent. As ConnectionFactory you can simply set up the normal Factory your JMS provider offers or bind a JNDI ConnectionFactory. In this example we use the ConnectionFactory provided by ActiveMQ.

```
<bean id="jmsConnectionFactory" class="org.apache.activemq.ActiveMQConnectionFactory">
  <property name="brokerURL" value="tcp://localhost:61616" />
</bean>
```

Then we set up the JMSComponent. It offers a new transport prefix to camel that we simply call jms. If we need several JMSComponents we can differentiate them by their name.

```
<bean id="jms" class="org.apache.camel.component.jms.JmsComponent">
  <property name="connectionFactory" ref="jmsConnectionFactory" />
  <property name="useMessageIDAsCorrelationID" value="true" />
</bean>
```

You can find more details about the JMSComponent at the Camel Wiki. For example you find the complete configuration options and a JNDI sample there.

## Setting up the CXF client

We will configure a simple CXF webservice client. It will use stub code generated from a wsdl. The webservice client will be configured to use JMS directly. You can also use a direct: Endpoint and do the routing to JMS in the Camel Context.

```
<client id="CustomerService" xmlns="http://cxf.apache.org/jaxws"
  xmlns:customer="http://customerservice.example.com/"
  serviceName="customer:CustomerServiceService"
  endpointName="customer:CustomerServiceEndpoint"
```

```
address="camel:jms:queue:CustomerService"
serviceClass="com.example.customerservice.CustomerService">
</client>
```

We explicitly configure `serviceName` and `endpointName` so they are not read from the wsdl. The names we use are arbitrary and have no further function but we set them to look nice. The `serviceClass` points to the service interface that was generated from the wsdl. Now the important thing is `address`. Here we tell cxf to use the camel transport, use the `JmsComponent` who registered the prefix "jms" and use the queue "CustomerService".

## Setting up the CamelContext

As we do not need additional routing an empty `CamelContext` bean will suffice.

```
<camelContext id="camelContext" xmlns="http://activemq.apache.org/camel/schema/spring">
</camelContext>
```

## Running the Example

- Download the example project [here](#)
- Follow the `readme.txt`

## Conclusion

As you have seen in this example you can use Camel to dramatically ease JMS configuration compared with CXF's native JMS Transport. This is of course only a workaround. The CXF team already works on the native JMS config for CXF to make it at least as good as Camel's. As CXF and Camel are two projects that have very good connections between them it is perhaps even possible to have a common transport layer for CXF and camel.

## TUTORIAL USING AXIS 1.4 WITH APACHE CAMEL

- Tutorial using Axis 1.4 with Apache Camel
  - Prerequisites
  - Distribution
  - Introduction
  - Setting up the project to run Axis
    - Maven 2
    - wsdl
    - Configuring Axis
    - Running the Example
  - Integrating Spring
    - Using Spring
  - Integrating Camel

- CamelContext
- Store a file backup
- Running the example
- Unit Testing
  - Smarter Unit Testing with Spring
- Unit Test calling Webservice
- Annotations
- The End
- See Also

## Prerequisites

This tutorial uses Maven 2 to setup the Camel project and for dependencies for artifacts.

## Distribution

This sample is distributed with the Camel 1.5 distribution as `examples/camel-example-axis`.

## Introduction

Apache Axis is/was widely used as a webservice framework. So in line with some of the other tutorials to demonstrate how Camel is not an invasive framework but is flexible and integrates well with existing solution.

We have an existing solution that exposes a webservice using Axis 1.4 deployed as web applications. This is a common solution. We use contract first so we have Axis generated source code from an existing wsdl file. Then we show how we introduce Spring and Camel to integrate with Axis.

This tutorial uses the following frameworks:

- Maven 2.0.9
- Apache Camel 1.5.0
- Apache Axis 1.4
- Spring 2.5.5

## Setting up the project to run Axis

This first part is about getting the project up to speed with Axis. We are not touching Camel or Spring at this time.

## Maven 2

Axis dependencies is available for maven 2 so we configure our pom.xml as:

```

<dependency>
  <groupId>org.apache.axis</groupId>
  <artifactId>axis</artifactId>
  <version>1.4</version>
</dependency>

<dependency>
  <groupId>org.apache.axis</groupId>
  <artifactId>axis-jaxrpc</artifactId>
  <version>1.4</version>
</dependency>

<dependency>
  <groupId>org.apache.axis</groupId>
  <artifactId>axis-saaj</artifactId>
  <version>1.4</version>
</dependency>

<dependency>
  <groupId>axis</groupId>
  <artifactId>axis-wsdl4j</artifactId>
  <version>1.5.1</version>
</dependency>

<dependency>
  <groupId>commons-discovery</groupId>
  <artifactId>commons-discovery</artifactId>
  <version>0.4</version>
</dependency>

<dependency>
  <groupId>log4j</groupId>
  <artifactId>log4j</artifactId>
  <version>1.2.14</version>
</dependency>

```

Then we need to configure maven to use Java 1.5 and the Axis maven plugin that generates the source code based on the wsdl file:

```

<!-- to compile with 1.5 -->
<plugin>
  <groupId>org.apache.maven.plugins</groupId>
  <artifactId>maven-compiler-plugin</artifactId>
  <configuration>
    <source>1.5</source>
    <target>1.5</target>
  </configuration>
</plugin>

<plugin>
  <groupId>org.codehaus.mojo</groupId>
  <artifactId>axistools-maven-plugin</artifactId>
  <configuration>
    <sourceDirectory>src/main/resources/</sourceDirectory>
    <packageSpace>com.mycompany.myschema</packageSpace>
    <testCases>>false</testCases>
  </configuration>
</plugin>

```

```

        <serverSide>true</serverSide>
        <subPackageByFileName>>false</subPackageByFileName>
    </configuration>
    <executions>
        <execution>
            <goals>
                <goal>wsdl2java</goal>
            </goals>
        </execution>
    </executions>
</plugin>

```

## wsdl

We use the same .wsdl file as the Tutorial-Example-ReportIncident and copy it to `src/main/webapp/WEB-INF/wsdl`

```

<?xml version="1.0" encoding="ISO-8859-1"?>
<wsdl:definitions xmlns:soap="http://schemas.xmlsoap.org/wsdl/soap/"
    xmlns:tns="http://reportincident.example.camel.apache.org"
    xmlns:xs="http://www.w3.org/2001/XMLSchema"
    xmlns:http="http://schemas.xmlsoap.org/wsdl/http/"
    xmlns:wsdl="http://schemas.xmlsoap.org/wsdl/"
    targetNamespace="http://reportincident.example.camel.apache.org">

    <!-- Type definitions for input- and output parameters for webservice -->
    <wsdl:types>
    <xs:schema targetNamespace="http://reportincident.example.camel.apache.org">
        <xs:element name="inputReportIncident">
            <xs:complexType>
                <xs:sequence>
                    <xs:element type="xs:string"
name="incidentId" />
                    <xs:element type="xs:string"
name="incidentDate" />
                    <xs:element type="xs:string"
name="givenName" />
                    <xs:element type="xs:string"
name="familyName" />
                    <xs:element type="xs:string"
name="summary" />
                    <xs:element type="xs:string"
name="details" />
                    <xs:element type="xs:string"
name="email" />
                    <xs:element type="xs:string"
name="phone" />
                </xs:sequence>
            </xs:complexType>
        </xs:element>
        <xs:element name="outputReportIncident">
            <xs:complexType>
                <xs:sequence>

```

```

                                <xs:element type="xs:string"
name="code" />
                                </xs:sequence>
                                </xs:complexType>
                                </xs:element>
                                </xs:schema>
</wsdl:types>

<!-- Message definitions for input and output -->
<wsdl:message name="inputReportIncident">
    <wsdl:part name="parameters" element="tns:inputReportIncident" />
</wsdl:message>
<wsdl:message name="outputReportIncident">
    <wsdl:part name="parameters" element="tns:outputReportIncident" />
</wsdl:message>

<!-- Port (interface) definitions -->
<wsdl:portType name="ReportIncidentEndpoint">
    <wsdl:operation name="ReportIncident">
        <wsdl:input message="tns:inputReportIncident" />
        <wsdl:output message="tns:outputReportIncident" />
    </wsdl:operation>
</wsdl:portType>

<!-- Port bindings to transports and encoding - HTTP, document literal
encoding is used -->
<wsdl:binding name="ReportIncidentBinding" type="tns:ReportIncidentEndpoint">
    <soap:binding transport="http://schemas.xmlsoap.org/soap/http" />
    <wsdl:operation name="ReportIncident">
        <soap:operation
soapAction="http://reportincident.example.camel.apache.org/ReportIncident"
                    style="document" />
        <wsdl:input>
            <soap:body parts="parameters" use="literal" />
        </wsdl:input>
        <wsdl:output>
            <soap:body parts="parameters" use="literal" />
        </wsdl:output>
    </wsdl:operation>
</wsdl:binding>

<!-- Service definition -->
<wsdl:service name="ReportIncidentService">
    <wsdl:port name="ReportIncidentPort"
binding="tns:ReportIncidentBinding">
        <soap:address
location="http://reportincident.example.camel.apache.org" />
    </wsdl:port>
</wsdl:service>

</wsdl:definitions>

```

## Configuring Axis

Okay we are now setup for the contract first development and can generate the source file. For now we are still only using standard Axis and not Spring nor Camel. We still need to setup Axis as a web application so we configure the web.xml in `src/main/webapp/WEB-INF/web.xml` as:

```
<servlet>
  <servlet-name>axis</servlet-name>
  <servlet-class>org.apache.axis.transport.http.AxisServlet</servlet-class>
</servlet>

<servlet-mapping>
  <servlet-name>axis</servlet-name>
  <url-pattern>/services/*</url-pattern>
</servlet-mapping>
```

The web.xml just registers Axis servlet that is handling the incoming web requests to its servlet mapping. We still need to configure Axis itself and this is done using its special configuration file `server-config.wsdd`. We nearly get this file for free if we let Axis generate the source code so we run the maven goal:

```
mvn axistools:wsdl2java
```

The tool will generate the source code based on the wsdl and save the files to the following folder:

```
.\target\generated-sources\axistools\wsdl2java\org\apache\camel\example\reportincident
deploy.wsdd
InputReportIncident.java
OutputReportIncident.java
ReportIncidentBindingImpl.java
ReportIncidentBindingStub.java
ReportIncidentService_PortType.java
ReportIncidentService_Service.java
ReportIncidentService_ServiceLocator.java
undeploy.wsdd
```

This is standard Axis and so far no Camel or Spring has been touched. To implement our webservice we will add our code, so we create a new class `AxisReportIncidentService` that implements the port type interface where we can implement our code logic what happens when the webservice is invoked.

```
package org.apache.camel.example.axis;

import org.apache.camel.example.reportincident.InputReportIncident;
import org.apache.camel.example.reportincident.OutputReportIncident;
import org.apache.camel.example.reportincident.ReportIncidentService_PortType;

import java.rmi.RemoteException;

/**
 * Axis webservice
```



```

*/
public class AxisReportIncidentService implements ReportIncidentService_PortType {

    public OutputReportIncident reportIncident(InputReportIncident parameters) throws
RemoteException {
        System.out.println("Hello AxisReportIncidentService is called from " +
parameters.getGivenName());

        OutputReportIncident out = new OutputReportIncident();
        out.setCode("OK");
        return out;
    }
}
}

```

Now we need to configure Axis itself and this is done using its server-config.wsdd file. We nearly get this for free from the auto generated code, we copy the stuff from deploy.wsdd and made a few modifications:

```

<?xml version="1.0" encoding="UTF-8"?>
<deployment xmlns="http://xml.apache.org/axis/wsdd/" xmlns:java="http://xml.apache.org/
axis/wsdd/providers/java">
  <!-- global configuration -->
    <globalConfiguration>
      <parameter name="sendXsiTypes" value="true"/>
      <parameter name="sendMultiRefs" value="true"/>
      <parameter name="sendXMLDeclaration" value="true"/>
      <parameter name="axis.sendMinimizedElements" value="true"/>
    </globalConfiguration>
    <handler name="URLMapper" type="java:org.apache.axis.handlers.http.URLMapper"/>

    <!-- this service is from deploy.wsdd -->
    <service name="ReportIncidentPort" provider="java:RPC" style="document"
use="literal">
      <parameter name="wsdlTargetNamespace"
value="http://reportincident.example.camel.apache.org"/>
      <parameter name="wsdlServiceElement" value="ReportIncidentService"/>
      <parameter name="schemaUnqualified"
value="http://reportincident.example.camel.apache.org"/>
      <parameter name="wsdlServicePort" value="ReportIncidentPort"/>
      <parameter name="className"
value="org.apache.camel.example.reportincident.ReportIncidentBindingImpl"/>
      <parameter name="wsdlPortType" value="ReportIncidentService"/>
      <parameter name="typeMappingVersion" value="1.2"/>
      <operation name="reportIncident" qname="ReportIncident"
returnQName="retNS:outputReportIncident"
xmlns:retNS="http://reportincident.example.camel.apache.org"
returnType="rtns:>outputReportIncident"
xmlns:rtns="http://reportincident.example.camel.apache.org"
soapAction="http://reportincident.example.camel.apache.org/
ReportIncident" >
        <parameter qname="pns:inputReportIncident"
xmlns:pns="http://reportincident.example.camel.apache.org"
type="tns:>inputReportIncident"
xmlns:tns="http://reportincident.example.camel.apache.org"/>

```

```

</operation>
<parameter name="allowedMethods" value="reportIncident" />

<typeMapping
  xmlns:ns="http://reportincident.example.camel.apache.org"
  qname="ns:>outputReportIncident"
  type="java.org.apache.camel.example.reportincident.OutputReportIncident"
  serializer="org.apache.axis.encoding.ser.BeanSerializerFactory"
  deserializer="org.apache.axis.encoding.ser.BeanDeserializerFactory"
  encodingStyle=""
/>
<typeMapping
  xmlns:ns="http://reportincident.example.camel.apache.org"
  qname="ns:>inputReportIncident"
  type="java.org.apache.camel.example.reportincident.InputReportIncident"
  serializer="org.apache.axis.encoding.ser.BeanSerializerFactory"
  deserializer="org.apache.axis.encoding.ser.BeanDeserializerFactory"
  encodingStyle=""
/>
</service>

<!-- part of Axis configuration -->
<transport name="http">
  <requestFlow>
    <handler type="URLMapper" />
    <handler
type="java.org.apache.axis.handlers.http.HTTPAuthHandler" />
  </requestFlow>
</transport>
</deployment>

```

The **globalConfiguration** and **transport** is not in the `deploy.wsdd` file so you gotta write that yourself. The **service** is a 100% copy from `deploy.wsdd`. Axis has more configuration to it than shown here, but then you should check the Axis documentation.

What we need to do now is important, as we need to modify the above configuration to use our webservice class than the default one, so we change the `className` parameter to our class **AxisReportIncidentService**:

```

<parameter name="className"
value="org.apache.camel.example.axis.AxisReportIncidentService" />

```

## Running the Example

Now we are ready to run our example for the first time, so we use Jetty as the quick web container using its maven command:

```
mvn jetty:run
```

Then we can hit the web browser and enter this URL: `http://localhost:8080/camel-example-axis/services` and you should see the famous Axis start page with the text **And now... Some Services**.

Clicking on the .wsdl link shows the wsdl file, but what. It's an auto generated one and not our original .wsdl file. So we need to fix this ASAP and this is done by configuring Axis in the server-config.wsdd file:

```
<service name="ReportIncidentPort" provider="java:RPC" style="document" use="literal">
  <wsdlFile>/WEB-INF/wsdl/report_incident.wsdl</wsdlFile>
  ...
```

We do this by adding the wsdlFile tag in the service element where we can point to the real .wsdl file.

## Integrating Spring

First we need to add its dependencies to the **pom.xml**.

```
<dependency>
  <groupId>org.springframework</groupId>
  <artifactId>spring-web</artifactId>
  <version>2.5.5</version>
</dependency>
```

Spring is integrated just as it would like to, we add its listener to the web.xml and a context parameter to be able to configure precisely what spring xml files to use:

```
<context-param>
  <param-name>contextConfigLocation</param-name>
  <param-value>
    classpath:axis-example-context.xml
  </param-value>
</context-param>

<listener>

<listener-class>org.springframework.web.context.ContextLoaderListener</listener-class>
</listener>
```

Next is to add a plain spring XML file named **axis-example-context.xml** in the src/main/resources folder.

```
<?xml version="1.0" encoding="UTF-8"?>
<beans xmlns="http://www.springframework.org/schema/beans"
  xmlns:xsi="http://www.w3.org/2001/XMLSchema-instance"
  xsi:schemaLocation="
    http://www.springframework.org/schema/beans http://www.springframework.org/
    schema/beans/spring-beans-2.5.xsd">
</beans>
```

The spring XML file is currently empty. We hit jetty again with `mvn jetty:run` just to make sure Spring was setup correctly.

## Using Spring

We would like to be able to get hold of the Spring ApplicationContext from our webservice so we can get access to the glory spring, but how do we do this? And our webservice class AxisReportIncidentService is created and managed by Axis we want to let Spring do this. So we have two problems.

We solve these problems by creating a delegate class that Axis creates, and this delegate class gets hold on Spring and then gets our real webservice as a spring bean and invoke the service.

First we create a new class that is 100% independent from Axis and just a plain POJO. This is our real service.

```
package org.apache.camel.example.axis;

import org.apache.camel.example.reportincident.InputReportIncident;
import org.apache.camel.example.reportincident.OutputReportIncident;

/**
 * Our real service that is not tied to Axis
 */
public class ReportIncidentService {

    public OutputReportIncident reportIncident(InputReportIncident parameters) {
        System.out.println("Hello ReportIncidentService is called from " +
            parameters.getGivenName());

        OutputReportIncident out = new OutputReportIncident();
        out.setCode("OK");
        return out;
    }
}
```

So now we need to get from AxisReportIncidentService to this one ReportIncidentService using Spring. Well first of all we add our real service to spring XML configuration file so Spring can handle its lifecycle:

```
<?xml version="1.0" encoding="UTF-8"?>
<beans xmlns="http://www.springframework.org/schema/beans"
       xmlns:xsi="http://www.w3.org/2001/XMLSchema-instance"
       xsi:schemaLocation="
           http://www.springframework.org/schema/beans http://www.springframework.org/
           schema/beans/spring-beans-2.5.xsd">

    <bean id="incidentservice"
        class="org.apache.camel.example.axis.ReportIncidentService"/>
</beans>
```

And then we need to modify AxisReportIncidentService to use Spring to lookup the spring bean **id="incidentservice"** and delegate the call. We do this by extending the spring class

org.springframework.remoting.jaxrpc.ServletEndpointSupport so the refactored code is:

```
package org.apache.camel.example.axis;

import org.apache.camel.example.reportincident.InputReportIncident;
import org.apache.camel.example.reportincident.OutputReportIncident;
import org.apache.camel.example.reportincident.ReportIncidentService_PortType;
import org.springframework.remoting.jaxrpc.ServletEndpointSupport;

import java.rmi.RemoteException;

/**
 * Axis webservice
 */
public class AxisReportIncidentService extends ServletEndpointSupport implements
ReportIncidentService_PortType {

    public OutputReportIncident reportIncident(InputReportIncident parameters) throws
RemoteException {
        // get hold of the spring bean from the application context
        ReportIncidentService service = (ReportIncidentService)
getApplicationContext().getBean("incidentService");

        // delegate to the real service
        return service.reportIncident(parameters);
    }
}
```

To see if everything is okay we run `mvn jetty:run`.

In the code above we get hold of our service at each request by looking up in the application context. However Spring also supports an **init** method where we can do this once. So we change the code to:

```
public class AxisReportIncidentService extends ServletEndpointSupport implements
ReportIncidentService_PortType {

    private ReportIncidentService service;

    @Override
    protected void onInit() throws ServiceException {
        // get hold of the spring bean from the application context
        service = (ReportIncidentService)
getApplicationContext().getBean("incidentService");
    }

    public OutputReportIncident reportIncident(InputReportIncident parameters) throws
RemoteException {
        // delegate to the real service
        return service.reportIncident(parameters);
    }
}
```

So now we have integrated Axis with Spring and we are ready for Camel.

## Integrating Camel

Again the first step is to add the dependencies to the maven **pom.xml** file:

```
<dependency>
  <groupId>org.apache.camel</groupId>
  <artifactId>camel-core</artifactId>
  <version>1.5.0</version>
</dependency>

<dependency>
  <groupId>org.apache.camel</groupId>
  <artifactId>camel-spring</artifactId>
  <version>1.5.0</version>
</dependency>
```

Now that we have integrated with Spring then we easily integrate with Camel as Camel works well with Spring.

We choose to integrate Camel in the Spring XML file so we add the camel namespace and the schema location:

```
xmlns:camel="http://activemq.apache.org/camel/schema/spring"
http://activemq.apache.org/camel/schema/spring http://activemq.apache.org/camel/schema/
spring/camel-spring.xsd"
```

## CamelContext

CamelContext is the heart of Camel its where all the routes, endpoints, components, etc. is registered. So we setup a CamelContext and the spring XML files looks like:

```
<?xml version="1.0" encoding="UTF-8"?>
<beans xmlns="http://www.springframework.org/schema/beans"
  xmlns:xsi="http://www.w3.org/2001/XMLSchema-instance"
  xmlns:camel="http://activemq.apache.org/camel/schema/spring"
  xsi:schemaLocation="
    http://www.springframework.org/schema/beans http://www.springframework.org/
schema/beans/spring-beans-2.5.xsd
    http://activemq.apache.org/camel/schema/spring http://activemq.apache.org/
camel/schema/spring/camel-spring.xsd">

  <bean id="incidentService"
class="org.apache.camel.example.axis.ReportIncidentService"/>

  <camel:camelContext id="camel">
    <!-- TODO: Here we can add Camel stuff -->
  </camel:camelContext>

</beans>
```



## Camel does not require Spring

Camel does not require Spring, we could easily have used Camel without Spring, but most users prefer to use Spring also.

## Store a file backup

We want to store the web service request as a file before we return a response. To do this we want to send the file content as a message to an endpoint that produces the file. So we need to do two steps:

- configure the file backup endpoint
- send the message to the endpoint

The endpoint is configured in spring XML so we just add it as:

```
<camel:camelContext id="camelContext">
  <!-- endpoint named backup that is configured as a file component -->
  <camel:endpoint id="backup" uri="file://target?append=false"/>
</camel:camelContext>
```

In the CamelContext we have defined our endpoint with the id `backup` and configured it use the URL notation that we know from the internet. Its a `file` scheme that accepts a context and some options. The context is `target` and its the folder to store the file. The option is just as the internet with `?` and `&` for subsequent options. We configure it to not append, meaning than any existing file will be overwritten. See the File component for options and how to use the camel file endpoint.

Next up is to be able to send a message to this endpoint. The easiest way is to use a `ProducerTemplate`. A `ProducerTemplate` is inspired by Spring template pattern with for instance `JmsTemplate` or `JdbcTemplate` in mind. The template that all the grunt work and exposes a simple interface to the end-user where he/she can set the payload to send. Then the template will do proper resource handling and all related issues in that regard. But how do we get hold of such a template? Well the `CamelContext` is able to provide one. This is done by configuring the template on the camel context in the spring XML as:

```
<camel:camelContext id="camelContext">
  <!-- producer template exposed with this id -->
  <camel:template id="camelTemplate"/>

  <!-- endpoint named backup that is configured as a file component -->
  <camel:endpoint id="backup" uri="file://target?append=false"/>
</camel:camelContext>
```

Then we can expose a `ProducerTemplate` property on our service with a setter in the Java code as:

```
public class ReportIncidentService {

    private ProducerTemplate template;
```

```

public void setTemplate(ProducerTemplate template) {
    this.template = template;
}

```

And then let Spring handle the dependency inject as below:

```

<bean id="incidentService" class="org.apache.camel.example.axis.ReportIncidentService">
    <!-- set the producer template to use from the camel context below -->
    <property name="template" ref="camelTemplate"/>
</bean>

```

Now we are ready to use the producer template in our service to send the payload to the endpoint. The template has many **sendXXX** methods for this purpose. But before we send the payload to the file endpoint we must also specify what filename to store the file as. This is done by sending meta data with the payload. In Camel metadata is sent as headers. Headers is just a plain Map<String, Object>. So if we needed to send several metadata then we could construct an ordinary HashMap and put the values in there. But as we just need to send one header with the filename Camel has a convenient send method `sendBodyAndHeader` so we choose this one.

```

public OutputReportIncident reportIncident(InputReportIncident parameters) {
    System.out.println("Hello ReportIncidentService is called from " +
parameters.getGivenName());

    String data = parameters.getDetails();

    // store the data as a file
    String filename = parameters.getIncidentId() + ".txt";
    // send the data to the endpoint and the header contains what filename it
should be stored as
    template.sendBodyAndHeader("backup", data, "org.apache.camel.file.name",
filename);

    OutputReportIncident out = new OutputReportIncident();
    out.setCode("OK");
    return out;
}

```

The template in the code above uses 4 parameters:

- the endpoint name, in this case the id referring to the endpoint defined in Spring XML in the camelContext element.
- the payload, can be any kind of object
- the key for the header, in this case a Camel keyword to set the filename
- and the value for the header

## Running the example

We start our integration with maven using `mvn jetty:run`. Then we open a browser and hit `http://localhost:8080`. Jetty is so smart that it display a frontpage with links to the deployed application so just hit the link and you get our application. Now we hit append



/services to the URL to access the Axis frontpage. The URL should be `http://localhost:8080/camel-example-axis/services`.

You can then test it using a web service test tools such as SoapUI.

Hitting the service will output to the console

```
2008-09-06 15:01:41.718::INFO: Started SelectChannelConnector @ 0.0.0.0:8080
[INFO] Started Jetty Server
Hello ReportIncidentService is called from Ibsen
```

And there should be a file in the target subfolder.

```
dir target /b
123.txt
```

## Unit Testing

We would like to be able to unit test our **ReportIncidentService** class. So we add junit to the maven dependency:

```
<dependency>
  <groupId>junit</groupId>
  <artifactId>junit</artifactId>
  <version>3.8.2</version>
  <scope>test</scope>
</dependency>
```

And then we create a plain junit testcase for our service class.

```
package org.apache.camel.example.axis;

import junit.framework.TestCase;
import org.apache.camel.example.reportincident.InputReportIncident;
import org.apache.camel.example.reportincident.OutputReportIncident;

/**
 * Unit test of service
 */
public class ReportIncidentServiceTest extends TestCase {

    public void testIncident() {
        ReportIncidentService service = new ReportIncidentService();

        InputReportIncident input = createDummyIncident();
        OutputReportIncident output = service.reportIncident(input);
        assertEquals("OK", output.getCode());
    }

    protected InputReportIncident createDummyIncident() {
        InputReportIncident input = new InputReportIncident();
        input.setEmail("davsclaus@apache.org");
        input.setIncidentId("12345678");
        input.setIncidentDate("2008-07-13");
        input.setPhone("+45 2962 7576");
        input.setSummary("Failed operation");
    }
}
```

```

        input.setDetails("The wrong foot was operated.");
        input.setFamilyName("Ibsen");
        input.setGivenName("Claus");
        return input;
    }
}

```

Then we can run the test with maven using: `mvn test`. But we will get a failure:

```

Running org.apache.camel.example.axis.ReportIncidentServiceTest
Hello ReportIncidentService is called from Claus
Tests run: 1, Failures: 0, Errors: 1, Skipped: 0, Time elapsed: 0.235 sec <<< FAILURE!

Results :

Tests in error:
  testIncident(org.apache.camel.example.axis.ReportIncidentServiceTest)

Tests run: 1, Failures: 0, Errors: 1, Skipped: 0

```

What is the problem? Well our service uses a CamelProducer (the template) to send a message to the file endpoint so the message will be stored in a file. What we need is to get hold of such a producer and inject it on our service, by calling the setter.

Since Camel is very light weight and embedable we are able to create a CamelContext and add the endpoint in our unit test code directly. We do this to show how this is possible:

```

private CamelContext context;

@Override
protected void setUp() throws Exception {
    super.setUp();
    // CamelContext is just created like this
    context = new DefaultCamelContext();

    // then we can create our endpoint and set the options
    FileEndpoint endpoint = new FileEndpoint();
    // the endpoint must have the camel context set also
    endpoint.setCamelContext(context);
    // our output folder
    endpoint.setFile(new File("target"));
    // and the option not to append
    endpoint.setAppend(false);

    // then we add the endpoint just in java code just as the spring XML, we
register it with the "backup" id.
    context.addSingletonEndpoint("backup", endpoint);

    // finally we need to start the context so Camel is ready to rock
    context.start();
}

@Override
protected void tearDown() throws Exception {
    super.tearDown();
}

```

```

    // and we are nice boys so we stop it to allow resources to clean up
    context.stop();
}

```

So now we are ready to set the `ProducerTemplate` on our service, and we get a hold of that baby from the `CamelContext` as:

```

public void testIncident() {
    ReportIncidentService service = new ReportIncidentService();

    // get a producer template from the camel context
    ProducerTemplate template = context.createProducerTemplate();
    // inject it on our service using the setter
    service.setTemplate(template);

    InputReportIncident input = createDummyIncident();
    OutputReportIncident output = service.reportIncident(input);
    assertEquals("OK", output.getCode());
}

```

And this time when we run the unit test its a success:

```

Results :

Tests run: 1, Failures: 0, Errors: 0, Skipped: 0

```

We would like to test that the file exists so we add these two lines to our test method:

```

// should generate a file also
File file = new File("target/" + input.getIncidentId() + ".txt");
assertTrue("File should exists", file.exists());

```

## Smarter Unit Testing with Spring

The unit test above requires us to assemble the Camel pieces manually in java code. What if we would like our unit test to use our spring configuration file **axis-example-context.xml** where we already have setup the endpoint. And of course we would like to test using this configuration file as this is the real file we will use. Well hey presto the xml file is a spring `ApplicationContext` file and spring is able to load it, so we go the spring path for unit testing. First we add the `spring-test` jar to our maven dependency:

```

<dependency>
    <groupId>org.springframework</groupId>
    <artifactId>spring-test</artifactId>
    <scope>test</scope>
</dependency>

```

And then we refactor our unit test to be a standard spring unit class. What we need to do is to extend `AbstractJUnit38SpringContextTests` instead of `TestCase` in our unit test. Since Spring 2.5 embraces annotations we will use one as well to instruct what our xml configuration file is located:

```
@ContextConfiguration(locations = "classpath:axis-example-context.xml")
public class ReportIncidentServiceTest extends AbstractJUnit38SpringContextTests {
```

What we must remember to add is the **classpath:** prefix as our xml file is located in `src/main/resources`. If we omit the prefix then Spring will by default try to locate the xml file in the current package and that is `org.apache.camel.example.axis`. If the xml file is located outside the classpath you can use `file:` prefix instead. So with these two modifications we can get rid of all the setup and teardown code we had before and now we will test our real configuration.

The last change is to get hold of the producer template and now we can just refer to the bean id it has in the spring xml file:

```
<!-- producer template exposed with this id -->
<camel:template id="camelTemplate"/>
```

So we get hold of it by just getting it from the spring `ApplicationContext` as all spring users is used to do:

```
// get a producer template from the the spring context
ProducerTemplate template = (ProducerTemplate)
applicationContext.getBean("camelTemplate");
// inject it on our service using the setter
service.setTemplate(template);
```

Now our unit test is much better, and a real power of Camel is that it fits nicely with Spring and you can use standard Spring'ish unit test to test your Camel applications as well.

## Unit Test calling Webservice

What if you would like to execute a unit test where you send a webservice request to the **AxisReportIncidentService** how do we unit test this one? Well first of all the code is merely just a delegate to our real service that we have just tested, but nevertheless its a good question and we would like to know how. Well the answer is that we can exploit that fact that Jetty is also a slim web container that can be embedded anywhere just as Camel can. So we add this to our pom.xml:

```
<dependency>
  <groupId>org.mortbay.jetty</groupId>
  <artifactId>jetty</artifactId>
  <version>${jetty-version}</version>
  <scope>test</scope>
</dependency>
```

Then we can create a new class **AxisReportIncidentServiceTest** to unit test with Jetty. The code to setup Jetty is shown below with code comments:

```
public class AxisReportIncidentServiceTest extends TestCase {

  private Server server;

  private void startJetty() throws Exception {
```

```

// create an embedded Jetty server
server = new Server();

// add a listener on port 8080 on localhost (127.0.0.1)
Connector connector = new SelectChannelConnector();
connector.setPort(8080);
connector.setHost("127.0.0.1");
server.addConnector(connector);

// add our web context path
WebApplicationContext wac = new WebApplicationContext();
wac.setContextPath("/unittest");
// set the location of the exploded webapp where WEB-INF is located
// this is a nice feature of Jetty where we can point to src/main/webapp
wac.setWar("./src/main/webapp");
server.setHandler(wac);

// then start Jetty
server.setStopAtShutdown(true);
server.start();
}

@Override
protected void setUp() throws Exception {
    super.setUp();
    startJetty();
}

@Override
protected void tearDown() throws Exception {
    super.tearDown();
    server.stop();
}
}

```

Now we just need to send the incident as a webservice request using Axis. So we add the following code:

```

public void testReportIncidentWithAxis() throws Exception {
    // the url to the axis webservice exposed by jetty
    URL url = new URL("http://localhost:8080/unittest/services/ReportIncidentPort");

    // Axis stuff to get the port where we can send the webservice request
    ReportIncidentService_ServiceLocator locator = new ReportIncidentService_ServiceLocator();
    ReportIncidentService_PortType port = locator.getReportIncidentPort(url);

    // create input to send
    InputReportIncident input = createDummyIncident();
    // send the webservice and get the response
    OutputReportIncident output = port.reportIncident(input);
    assertEquals("OK", output.getCode());

    // should generate a file also
}

```

```

    File file = new File("target/" + input.getIncidentId() + ".txt");
    assertTrue("File should exists", file.exists());
}

protected InputReportIncident createDummyIncident() {
    InputReportIncident input = new InputReportIncident();
    input.setEmail("davsclaus@apache.org");
    input.setIncidentId("12345678");
    input.setIncidentDate("2008-07-13");
    input.setPhone("+45 2962 7576");
    input.setSummary("Failed operation");
    input.setDetails("The wrong foot was operated.");
    input.setFamilyName("Ibsen");
    input.setGivenName("Claus");
    return input;
}

```

And now we have an unittest that sends a webservice request using good old Axis.

## Annotations

Both Camel and Spring has annotations that can be used to configure and wire trivial settings more elegantly. Camel has the endpoint annotation `@EndpointInjected` that is just what we need. With this annotation we can inject the endpoint into our service. The annotation takes either a name or uri parameter. The name is the bean id in the Registry. The uri is the URI configuration for the endpoint. Using this you can actually inject an endpoint that you have not defined in the camel context. As we have defined our endpoint with the id **backup** we use the name parameter.

```

@EndpointInject(name = "backup")
private ProducerTemplate template;

```

Camel is smart as `@EndpointInjected` supports different kinds of object types. We like the `ProducerTemplate` so we just keep it as it is.

Since we use annotations on the field directly we do not need to set the property in the spring xml file so we change our service bean:

```

<bean id="incidentService"
class="org.apache.camel.example.axis.ReportIncidentService"/>

```

Running the unit test with `mvn test` reveals that it works nicely.

And since we use the `@EndpointInjected` that refers to the endpoint with the id `backup` directly we can loose the template tag in the xml, so its shorter:

```

<bean id="incidentService"
class="org.apache.camel.example.axis.ReportIncidentService">

    <camel:camelContext id="camelContext">
        <!-- producer template exposed with this id -->
        <camel:template id="camelTemplate"/>

        <!-- endpoint named backup that is configured as a file component -->

```

```
<camel:endpoint id="backup" uri="file://target?append=false"/>

</camel:camelContext>
```

And the final touch we can do is that since the endpoint is injected with concrete endpoint to use we can remove the "backup" name parameter when we send the message. So we change from:

```
// send the data to the endpoint and the header contains what filename it should be
stored as
    template.sendBodyAndHeader("backup", data, "org.apache.camel.file.name",
filename);
```

To without the name:

```
// send the data to the endpoint and the header contains what filename it should be
stored as
    template.sendBodyAndHeader(data, "org.apache.camel.file.name", filename);
```

Then we avoid to duplicate the name and if we rename the endpoint name then we don't forget to change it in the code also.

## The End

This tutorial hasn't really touched the one of the key concept of Camel as a powerful routing and mediation framework. But we wanted to demonstrate its flexibility and that it integrates well with even older frameworks such as Apache Axis 1.4.

Check out the other tutorials on Camel and the other examples.

Note that the code shown here also applies to Camel 1.4 so actually you can get started right away with the released version of Camel. As this time of writing Camel 1.5 is work in progress.

## See Also

- Tutorials
- Examples

## TUTORIAL ON USING CAMEL IN A WEB APPLICATION

Camel has been designed to work great with the Spring framework; so if you are already a Spring user you can think of Camel as just a framework for adding to your Spring XML files.

So you can follow the usual Spring approach to working with web applications; namely to add the standard Spring hook to load a **/WEB-INF/applicationContext.xml** file. In that file you can include your usual Camel XML configuration.

## Step 1: Edit your web.xml

To enable spring add a context loader listener to your **/WEB-INF/web.xml** file

```
<?xml version="1.0" encoding="UTF-8"?>
<web-app xmlns="http://java.sun.com/xml/ns/j2ee"
         xmlns:xsi="http://www.w3.org/2001/XMLSchema-instance"
         xsi:schemaLocation="http://java.sun.com/xml/ns/j2ee
         http://java.sun.com/xml/ns/j2ee/web-app_2_4.xsd"
         version="2.4">

    <listener>

<listener-class>org.springframework.web.context.ContextLoaderListener</listener-class>
    </listener>
</web-app>
```

This will cause Spring to boot up and look for the **/WEB-INF/applicationContext.xml** file.

## Step 2: Create a /WEB-INF/applicationContext.xml file

Now you just need to create your Spring XML file and add your camel routes or configuration.

For example

```
<?xml version="1.0" encoding="UTF-8"?>
<beans xmlns="http://www.springframework.org/schema/beans"
       xmlns:xsi="http://www.w3.org/2001/XMLSchema-instance"
       xmlns:context="http://www.springframework.org/schema/context"
       xsi:schemaLocation="
         http://www.springframework.org/schema/beans
         http://www.springframework.org/schema/beans/spring-beans-2.5.xsd
         http://www.springframework.org/schema/context
         http://www.springframework.org/schema/context/spring-context-2.5.xsd
         http://activemq.apache.org/camel/schema/spring
         http://activemq.apache.org/camel/schema/spring/camel-spring.xsd">

    <camelContext xmlns="http://activemq.apache.org/camel/schema/spring">
        <route>
            <from uri="seda:foo" />
            <to uri="mock:results" />
        </route>
    </camelContext>

</beans>
```

Then boot up your web application and you're good to go!

## Hints and Tips

If you use Maven to build your application your directory tree will look like this...



```
src/main/webapp/WEB-INF
web.xml
applicationContext.xml
```

To enable more rapid development we highly recommend the `jetty:run` maven plugin.

Please refer to the help for more information on using `jetty:run` - but briefly if you add the following to your `pom.xml`

```
<build>
  <plugins>
    <plugin>
      <groupId>org.mortbay.jetty</groupId>
      <artifactId>maven-jetty-plugin</artifactId>
      <webAppConfig>
        <contextPath>/</contextPath>
      </webAppConfig>
      <scanIntervalSeconds>10</scanIntervalSeconds>
    </configuration>
  </plugin>
</plugins>
</build>
```

Then you can run your web application as follows

```
mvn jetty:run
```

Then Jetty will also monitor your `target/classes` directory and your `src/main/webapp` directory so that if you modify your spring XML, your `web.xml` or your java code the web application will be restarted, re-creating your Camel routes.

If your unit tests take a while to run, you could miss them out when running your web application via

```
mvn -Dtest=false jetty:run
```

## TUTORIAL BUSINESS PARTNERS

### BACKGROUND AND INTRODUCTION

#### Business Background

So there's a company, which we'll call Acme. Acme sells widgets, in a fairly unusual way. Their customers are responsible for telling Acme what they purchased. The customer enters into their own systems (ERP or whatever) which widgets they bought from Acme. Then at some point, their systems emit a record of the sale which needs to go to Acme so Acme can bill them for it. Obviously, everyone wants this to be as automated as possible, so there needs to be integration between the customer's system and Acme.



## Under Construction

This tutorial is a work in progress.

Sadly, Acme's sales people are, technically speaking, doormats. They tell all their prospects, "you can send us the data in whatever format, using whatever protocols, whatever. You just can't change once it's up and running."

The result is pretty much what you'd expect. Taking a random sample of 3 customers:

- Customer 1: **XML over FTP**
- Customer 2: **CSV over HTTP**
- Customer 3: **Excel via e-mail**

Now on the Acme side, all this has to be converted to a canonical XML format and submitted to the Acme accounting system via JMS. Then the Acme accounting system does its stuff and sends an XML reply via JMS, with a summary of what it processed (e.g. 3 line items accepted, line item #2 in error, total invoice \$123.45). Finally, that data needs to be formatted into an e-mail, and sent to a contact at the customer in question ("Dear Joyce, we received an invoice on 1/2/08. We accepted 3 line items totaling \$123.45, though there was an error with line items #2 [invalid quantity ordered]. Thank you for your business. Love, Acme.").

So it turns out Camel can handle all this:

- Listen for HTTP, e-mail, and FTP files
- Grab attachments from the e-mail messages
- Convert XML, XLS, and CSV files to a canonical XML format
- read and write JMS messages
- route based on company ID
- format e-mails using Velocity templates
- send outgoing e-mail messages

## Tutorial Background

This tutorial will cover all that, plus setting up tests along the way.

Before starting, you should be familiar with:

- Camel concepts including the CamelContext, Routes, Components and Endpoints, and Enterprise Integration Patterns
- Configuring Camel with the XML or Java DSL

You'll learn:

- How to set up a Maven build for a Camel project
- How to transform XML, CSV, and Excel data into a standard XML format with Camel
  - How to write POJOs (Plain Old Java Objects), Velocity templates, and XSLT stylesheets that are invoked by Camel routes for message transformation
- How to configure simple and complex Routes in Camel, using either the XML or the Java DSL format

- How to set up unit tests that load a Camel configuration and test Camel routes
- How to use Camel's Data Formats to automatically convert data between Java objects and XML, CSV files, etc.
- How to send and receive e-mail from Camel
- How to send and receive JMS messages from Camel
- How to use Enterprise Integration Patterns including Message Router and Pipes and Filters
  - How to use various languages to express content-based routing rules in Camel
- How to deal with Camel messages, headers, and attachments

You may choose to treat this as a hands-on tutorial, and work through building the code and configuration files yourself. Each of the sections gives detailed descriptions of the steps that need to be taken to get the components and routes working in Camel, and takes you through tests to make sure they are working as expected.

But each section also links to working copies of the source and configuration files, so if you don't want the hands-on approach, you can simply review and/or download the finished files.

### High-Level Diagram

Here's more or less what the integration process looks like.

First, the input from the customers to Acme:

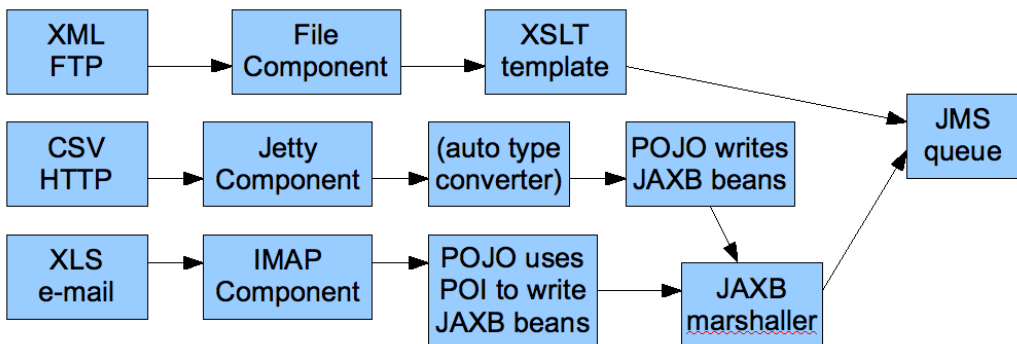

And then, the output from Acme to the customers:

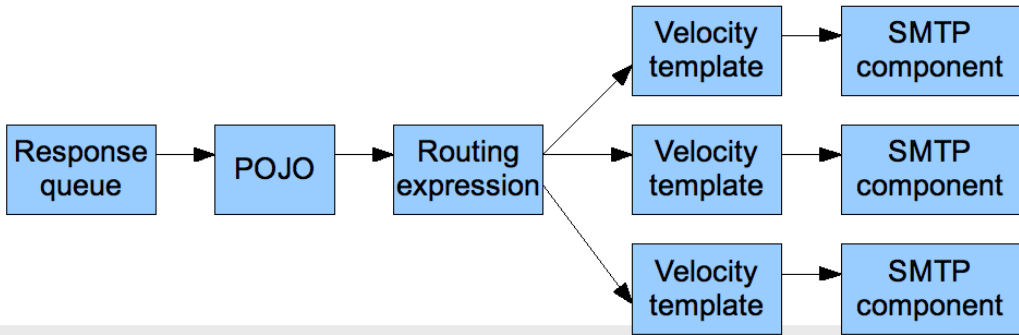

## Tutorial Tasks

To get through this scenario, we're going to break it down into smaller pieces, implement and test those, and then try to assemble the big scenario and test that.

Here's what we'll try to accomplish:

1. Create a Maven build for the project
2. Get sample files for the customer Excel, CSV, and XML input
3. Get a sample file for the canonical XML format that Acme's accounting system uses
4. Create an XSD for the canonical XML format
5. Create JAXB POJOs corresponding to the canonical XSD
6. Create an XSLT stylesheet to convert the Customer 1 (XML over FTP) messages to the canonical format
7. Create a unit test to ensure that a simple Camel route invoking the XSLT stylesheet works
8. Create a POJO that converts a `List<List<String>>` to the above JAXB POJOs
  - Note that Camel can automatically convert CSV input to a List of Lists of Strings representing the rows and columns of the CSV, so we'll use this POJO to handle Customer 2 (CSV over HTTP)
9. Create a unit test to ensure that a simple Camel route invoking the CSV processing works
10. Create a POJO that converts a Customer 3 Excel file to the above JAXB POJOs (using POI to read Excel)
11. Create a unit test to ensure that a simple Camel route invoking the Excel processing works
12. Create a POJO that reads an input message, takes an attachment off the message, and replaces the body of the message with the attachment
  - This is assuming for Customer 3 (Excel over e-mail) that the e-mail contains a single Excel file as an attachment, and the actual e-mail body is throwaway
13. Build a set of Camel routes to handle the entire input (Customer -> Acme) side of the scenario.
14. Build unit tests for the Camel input.

15. **TODO:** Tasks for the output (Acme -> Customer) side of the scenario

## LET'S GET STARTED!

### Step 1: Initial Maven build

We'll use Maven for this project as there will eventually be quite a few dependencies and it's nice to have Maven handle them for us. You should have a current version of Maven (e.g. 2.0.9) installed.

You can start with a pretty empty project directory and a Maven POM file, or use a simple JAR archetype to create one.

Here's a sample POM. We've added a dependency on **camel-core**, and set the compile version to 1.5 (so we can use annotations):

**Listing 8. pom.xml**

```
<?xml version="1.0" encoding="UTF-8"?>
<project xmlns="http://maven.apache.org/POM/4.0.0">
  <modelVersion>4.0.0</modelVersion>
  <groupId>org.apache.camel.tutorial</groupId>
  <artifactId>business-partners</artifactId>
  <version>1.0-SNAPSHOT</version>
  <name>Camel Business Partners Tutorial</name>
  <dependencies>
    <dependency>
      <artifactId>camel-core</artifactId>
      <groupId>org.apache.camel</groupId>
      <version>1.4.0</version>
    </dependency>
  </dependencies>
  <build>
    <plugins>
      <plugin>
        <groupId>org.apache.maven.plugins</groupId>
        <artifactId>maven-compiler-plugin</artifactId>
        <configuration>
          <source>1.5</source>
          <target>1.5</target>
        </configuration>
      </plugin>
    </plugins>
  </build>
</project>
```

### Step 2: Get Sample Files

You can make up your own if you like, but here are the "off the shelf" ones. You can save yourself some time by downloading these to `src/test/resources` in your Maven project.

- Customer 1 (XML): `input-customer1.xml`

- Customer 2 (CSV): input-customer2.csv
- Customer 3 (Excel): input-customer3.xls
- Canonical Acme XML Request: canonical-acme-request.xml
- Canonical Acme XML Response: **TODO**

If you look at these files, you'll see that the different input formats use different field names and/or ordering, because of course the sales guys were totally OK with that. Sigh.

### Step 3: XSD and JAXB Beans for the Canonical XML Format

Here's the sample of the canonical XML file:

```
<?xml version="1.0" encoding="UTF-8"?>
<invoice xmlns="http://activemq.apache.org/camel/tutorial/partners/invoice">
  <partner-id>2</partner-id>
  <date-received>9/12/2008</date-received>
  <line-item>
    <product-id>134</product-id>
    <description>A widget</description>
    <quantity>3</quantity>
    <item-price>10.45</item-price>
    <order-date>6/5/2008</order-date>
  </line-item>
  <!-- // more line-item elements here -->
  <order-total>218.82</order-total>
</invoice>
```

If you're ambitious, you can write your own XSD (XML Schema) for files that look like this, and save it to `src/main/xsd`.

**Solution:** If not, you can download mine, and save that to save it to `src/main/xsd`.

## Generating JAXB Beans

Down the road we'll want to deal with the XML as Java POJOs. We'll take a moment now to set up those XML binding POJOs. So we'll update the Maven POM to generate JAXB beans from the XSD file.

We need a dependency:

```
<dependency>
  <artifactId>camel-jaxb</artifactId>
  <groupId>org.apache.camel</groupId>
  <version>1.4.0</version>
</dependency>
```

And a plugin configured:

```
<plugin>
  <groupId>org.codehaus.mojo</groupId>
  <artifactId>jaxb2-maven-plugin</artifactId>
  <executions>
    <execution>
```

```
<goals>
  <goal>xjc</goal>
</goals>
</execution>
</executions>
</plugin>
```

That should do it (it automatically looks for XML Schemas in `src/main/xsd` to generate beans for). Run **mvn install** and it should emit the beans into `target/generated-sources/jaxb`. Your IDE should see them there, though you may need to update the project to reflect the new settings in the Maven POM.

#### Step 4: Initial Work on Customer I Input (XML over FTP)

To get a start on Customer I, we'll create an XSLT template to convert the Customer I sample file into the canonical XML format, write a small Camel route to test it, and build that into a unit test. If we get through this, we can be pretty sure that the XSLT template is valid and can be run safely in Camel.

### Create an XSLT template

Start with the Customer I sample input. You want to create an XSLT template to generate XML like the canonical XML sample above – an `invoice` element with `line-item` elements (one per item in the original XML document). If you're especially clever, you can populate the current date and order total elements too.

**Solution:** My sample XSLT template isn't that smart, but it'll get you going if you don't want to write one of your own.

### Create a unit test

Here's where we get to some meaty Camel work. We need to:

- Set up a unit test
- That loads a Camel configuration
- That has a route invoking our XSLT
- Where the test sends a message to the route
- And ensures that some XML comes out the end of the route

The easiest way to do this is to set up a Spring context that defines the Camel stuff, and then use a base unit test class from Spring that knows how to load a Spring context to run tests against. So, the procedure is:

## Set Up a Skeletal Camel/Spring Unit Test

1. Add dependencies on Camel-Spring, and the Spring test JAR (which will automatically bring in JUnit 3.8.x) to your POM:

```
<dependency>
  <artifactId>camel-spring</artifactId>
  <groupId>org.apache.camel</groupId>
  <version>1.4.0</version>
</dependency>
<dependency>
  <artifactId>spring-test</artifactId>
  <groupId>org.springframework</groupId>
  <version>2.5.5</version>
  <scope>test</scope>
</dependency>
```

2. Create a new unit test class in `src/test/java/your-package-here`, perhaps called `XMLInputTest.java`
3. Make the test extend Spring's `AbstractJUnit38SpringContextTests` class, so it can load a Spring context for the test
4. Create a Spring context configuration file in `src/test/resources`, perhaps called `XMLInputTest-context.xml`
5. In the unit test class, use the class-level `@ContextConfiguration` annotation to indicate that a Spring context should be loaded
  - By default, this looks for a Context configuration file called `TestClassName-context.xml` in a subdirectory corresponding to the package of the test class. For instance, if your test class was `org.apache.camel.tutorial.XMLInputTest`, it would look for `org/apache/camel/tutorial/XMLInputTest-context.xml`
  - To override this default, use the **locations** attribute on the `@ContextConfiguration` annotation to provide specific context file locations (starting each path with a `/` if you don't want it to be relative to the package directory). My solution does this so I can put the context file directly in `src/test/resources` instead of in a package directory under there.
6. Add a `CamelContext` instance variable to the test class, with the `@Autowired` annotation. That way Spring will automatically pull the `CamelContext` out of the Spring context and inject it into our test class.
7. Add a `ProducerTemplate` instance variable and a `setUp` method that instantiates it from the `CamelContext`. We'll use the `ProducerTemplate` later to send messages to the route.

```
protected ProducerTemplate<Exchange> template;

protected void setUp() throws Exception {
    super.setUp();
}
```



```

    template = camelContext.createProducerTemplate();
}

```

8. Put in an empty test method just for the moment (so when we run this we can see that "I test succeeded")
9. Add the Spring <beans> element (including the Camel Namespace) with an empty <camelContext> element to the Spring context, like this:

```

<?xml version="1.0" encoding="UTF-8"?>
<beans xmlns="http://www.springframework.org/schema/beans"
       xmlns:xsi="http://www.w3.org/2001/XMLSchema-instance"
       xsi:schemaLocation="http://www.springframework.org/schema/beans
                           http://www.springframework.org/schema/beans/
                           spring-beans-2.5.xsd
                           http://activemq.apache.org/camel/schema/spring
                           http://activemq.apache.org/camel/schema/spring/
                           camel-spring-1.4.0.xsd">

    <camelContext id="camel" xmlns="http://activemq.apache.org/camel/schema/
spring">
    </camelContext>
</beans>

```

Test it by running **mvn install** and make sure there are no build errors. So far it doesn't test much; just that your project and test and source files are all organized correctly, and the one empty test method completes successfully.

**Solution:** Your test class might look something like this:

- src/test/java/org/apache/camel/tutorial/XMLInputTest.java
- src/test/resources/XMLInputTest-context.xml (same as just above)

## Flesh Out the Unit Test

So now we're going to write a Camel route that applies the XSLT to the sample Customer I input file, and makes sure that some XML output comes out:

1. Save the input-customerI.xml file to src/test/resources
2. Save your XSLT file (created in the previous step) to src/main/resources
3. Write a Camel Route, either right in the Spring XML, or using the Java DSL (in another class under src/test/java somewhere). This route should use the Pipes and Filters integration pattern to:
  1. Start from the endpoint direct:start (which lets the test conveniently pass messages into the route)
  2. Call the endpoint xslt:YourXSLTFile.xml (to transform the message with the specified XSLT template)
  3. Send the result to the endpoint mock:finish (which lets the test verify the route output)
4. Add a test method to the unit test class that:
  1. Get a reference to the Mock endpoint mock:finish using code like this:

```
MockEndpoint finish = MockEndpoint.resolve(camelContext,
"mock:finish");
```

2. Set the expectedMessageCount on that endpoint to 1
3. Get a reference to the Customer 1 input file, using code like this:

```
InputStream in =
XMLInputTest.class.getResourceAsStream("/input-partner1.xml");
assertNotNull(in);
```

4. Send that InputStream as a message to the direct:start endpoint, using code like this:

```
template.sendBody("direct:start", in);
```

Note that we can send the sample file body in several formats (File, InputStream, String, etc.) but in this case an InputStream is pretty convenient.

5. Ensure that the message made it through the route to the final endpoint, by testing all configured Mock endpoints like this:

```
MockEndpoint.assertIsSatisfied(camelContext);
```

6. If you like, inspect the final message body using some code like `finish.getExchanges().get(0).getIn().getBody()`.
  - If you do this, you'll need to know what format that body is – String, byte array, InputStream, etc.
5. Run your test with **mvn install** and make sure the build completes successfully.

**Solution:** Your finished test might look something like this:

- `src/test/java/org/apache/camel/tutorial/XMLInputTest.java`
- For XML Configuration:
  - `src/test/resources/XMLInputTest-context.xml`
- Or, for Java DSL Configuration:
  - `src/test/resources/XMLInputTest-dsl-context.xml`
  - `src/test/java/org/apache/camel/tutorial/routes/XMLInputTestRoute.java`

## Step 5: Initial Work on Customer 2 Input (CSV over HTTP)

To get a start on Customer 2, we'll create a POJO to convert the Customer 2 sample CSV data into the JAXB POJOs representing the canonical XML format, write a small Camel route to test it, and build that into a unit test. If we get through this, we can be pretty sure that the CSV conversion and JAXB handling is valid and can be run safely in Camel.

## Create a CSV-handling POJO

To begin with, CSV is a known data format in Camel. Camel can convert a CSV file to a List (representing rows in the CSV) of Lists (representing cells in the row) of Strings (the data for



## Test Base Class

Once your test class is working, you might want to extract things like the `@Autowired CamelContext`, the `ProducerTemplate`, and the `setUp` method to a custom base class that you extend with your other tests.

each cell). That means our POJO can just assume the data coming in is of type `List<List<String>>`, and we can declare a method with that as the argument.

Looking at the JAXB code in `target/generated-sources/jaxb`, it looks like an `Invoice` object represents the whole document, with a nested list of `LineItemType` objects for the line items. Therefore our POJO method will return an `Invoice` (a document in the canonical XML format).

So to implement the CSV-to-JAXB POJO, we need to do something like this:

1. Create a new class under `src/main/java`, perhaps called `CSVConverterBean`.
2. Add a method, with one argument of type `List<List<String>>` and the return type `Invoice`
  - You may annotate the argument with `@Body` to specifically designate it as the body of the incoming message
3. In the method, the logic should look roughly like this:
  1. Create a new `Invoice`, using the method on the generated `ObjectFactory` class
  2. Loop through all the rows in the incoming CSV (the outer `List`)
  3. Skip the first row, which contains headers (column names)
  4. For the other rows:
    1. Create a new `LineItemType` (using the `ObjectFactory` again)
    2. Pick out all the cell values (the `Strings` in the inner `List`) and put them into the correct fields of the `LineItemType`
      - Not all of the values will actually go into the line item in this example
      - You may hardcode the column ordering based on the sample data file, or else try to read it dynamically from the headers in the first line
      - Note that you'll need to use a `JAXB DatatypeFactory` to create the `XMLGregorianCalendar` values that JAXB uses for the date fields in the XML – which probably means using a `SimpleDateFormat` to parse the date and setting that date on a `GregorianCalendar`
  3. Add the line item to the invoice

5. Populate the partner ID, date of receipt, and order total on the Invoice
6. Throw any exceptions out of the method, so Camel knows something went wrong
7. Return the finished Invoice

**Solution:** Here's an example of what the CSVConverterBean might look like.

## Create a unit test

Start with a simple test class and test Spring context like last time, perhaps based on the name CSVInputTest:

**Listing 9. CSVInputTest.java**

```
/**
 * A test class the ensure we can convert Partner 2 CSV input files to the
 * canonical XML output format, using JAXB POJOs.
 */
@ContextConfiguration(locations = "/CSVInputTest-context.xml")
public class CSVInputTest extends AbstractJUnit38SpringContextTests {
    @Autowired
    protected CamelContext camelContext;
    protected ProducerTemplate<Exchange> template;

    protected void setUp() throws Exception {
        super.setUp();
        template = camelContext.createProducerTemplate();
    }

    public void testCSVConversion() {
        // TODO
    }
}
```

**Listing 10. CSVInputTest-context.xml**

```
<?xml version="1.0" encoding="UTF-8"?>
<beans xmlns="http://www.springframework.org/schema/beans"
       xmlns:xsi="http://www.w3.org/2001/XMLSchema-instance"
       xsi:schemaLocation="http://www.springframework.org/schema/beans
                           http://www.springframework.org/schema/beans/
                           spring-beans-2.5.xsd
                           http://activemq.apache.org/camel/schema/spring
                           http://activemq.apache.org/camel/schema/spring/
                           camel-spring-1.4.0.xsd">

    <camelContext id="camel" xmlns="http://activemq.apache.org/camel/schema/spring">
        <!-- TODO -->
    </camelContext>
</beans>
```

Now the meaty part is to flesh out the test class and write the Camel routes.

- I. Update the Maven POM to include CSV Data Format support:

```
<dependency>
  <artifactId>camel-csv</artifactId>
  <groupId>org.apache.camel</groupId>
  <version>1.4.0</version>
</dependency>
```

2. Write the routes (right in the Spring XML context, or using the Java DSL) for the CSV conversion process, again using the Pipes and Filters pattern:
  1. Start from the endpoint `direct:CSVstart` (which lets the test conveniently pass messages into the route). We'll name this differently than the starting point for the previous test, in case you use the Java DSL and put all your routes in the same package (which would mean that each test would load the DSL routes for several tests.)
  2. This time, there's a little preparation to be done. Camel doesn't know that the initial input is a CSV, so it won't be able to convert it to the expected `List<List<String>>` without a little hint. For that, we need an unmarshal transformation in the route. The `unmarshal` method (in the DSL) or element (in the XML) takes a child indicating the format to unmarshal; in this case that should be `csv`.
  3. Next invoke the POJO to transform the message with a `bean:CSVConverter` endpoint
  4. As before, send the result to the endpoint `mock:finish` (which lets the test verify the route output)
  5. Finally, we need a Spring `<bean>` element in the Spring context XML file (but outside the `<camelContext>` element) to define the Spring bean that our route invokes. This Spring bean should have a `name` attribute that matches the name used in the bean endpoint (`CSVConverter` in the example above), and a `class` attribute that points to the CSV-to-JAXB POJO class you wrote above (such as, `org.apache.camel.tutorial.CSVConverterBean`). When Spring is in the picture, any bean endpoints look up Spring beans with the specified name.
3. Write a test method in the test class, which should look very similar to the previous test class:
  1. Get the `MockEndpoint` for the final endpoint, and tell it to expect one message
  2. Load the Partner 2 sample CSV file from the `ClassPath`, and send it as the body of a message to the starting endpoint
  3. Verify that the final `MockEndpoint` is satisfied (that is, it received one message) and examine the message body if you like
    - Note that we didn't marshal the JAXB POJOs to XML in this test, so the final message should contain an `Invoice` as the body. You could write a simple line of code to get the `Exchange` (and `Message`) from the `MockEndpoint` to confirm that.

4. Run this new test with **mvn install** and make sure it passes and the build completes successfully.

**Solution:** Your finished test might look something like this:

- `src/test/java/org/apache/camel/tutorial/CSVInputTest.java`
- For XML Configuration:
  - `src/test/resources/CSVInputTest-context.xml`
- Or, for Java DSL Configuration:
  - `src/test/resources/CSVInputTest-dsl-context.xml`
  - `src/test/java/org/apache/camel/tutorial/routes/CSVInputTestRoute.java`

### Step 6: Initial Work on Customer 3 Input (Excel over e-mail)

To get a start on Customer 3, we'll create a POJO to convert the Customer 3 sample Excel data into the JAXB POJOs representing the canonical XML format, write a small Camel route to test it, and build that into a unit test. If we get through this, we can be pretty sure that the Excel conversion and JAXB handling is valid and can be run safely in Camel.

## Create an Excel-handling POJO

Camel does not have a data format handler for Excel by default. We have two options – create an Excel `DataFormat` (so Camel can convert Excel spreadsheets to something like the CSV `List<List<String>>` automatically), or create a POJO that can translate Excel data manually. For now, the second approach is easier (if we go the `DataFormat` route, we need code to both read and write Excel files, whereas otherwise read-only will do).

So, we need a POJO with a method that takes something like an `InputStream` or `byte[]` as an argument, and returns in `Invoice` as before. The process should look something like this:

1. Update the Maven POM to include POI support:

```
<dependency>
  <artifactId>poi</artifactId>
  <groupId>org.apache.poi</groupId>
  <version>3.1-FINAL</version>
</dependency>
```

2. Create a new class under `src/main/java`, perhaps called `ExcelConverterBean`.
3. Add a method, with one argument of type `InputStream` and the return type `Invoice`
  - You may annotate the argument with `@Body` to specifically designate it as the body of the incoming message
4. In the method, the logic should look roughly like this:
  1. Create a new `Invoice`, using the method on the generated `ObjectFactory` class

2. Create a new `HSSFWorkbook` from the `InputStream`, and get the first sheet from it
3. Loop through all the rows in the sheet
4. Skip the first row, which contains headers (column names)
5. For the other rows:
  1. Create a new `LineItemType` (using the `ObjectFactory` again)
  2. Pick out all the cell values and put them into the correct fields of the `LineItemType` (you'll need some data type conversion logic)
    - Not all of the values will actually go into the line item in this example
    - You may hardcode the column ordering based on the sample data file, or else try to read it dynamically from the headers in the first line
    - Note that you'll need to use a `JAXB DatatypeFactory` to create the `XMLGregorianCalendar` values that `JAXB` uses for the date fields in the XML – which probably means setting the date from a date cell on a `GregorianCalendar`
  3. Add the line item to the invoice
6. Populate the partner ID, date of receipt, and order total on the `Invoice`
7. Throw any exceptions out of the method, so Camel knows something went wrong
8. Return the finished `Invoice`

**Solution:** Here's an example of what the `ExcelConverterBean` might look like.

## Create a unit test

The unit tests should be pretty familiar now. The test class and context for the Excel bean should be quite similar to the CSV bean.

1. Create the basic test class and corresponding Spring Context XML configuration file
2. The XML config should look a lot like the CSV test, except:
  - Remember to use a different start endpoint name if you're using the Java DSL and not use separate packages per test
  - You don't need the `unmarshal` step since the Excel POJO takes the raw `InputStream` from the source endpoint
  - You'll declare a `<bean>` and endpoint for the Excel bean prepared above instead of the CSV bean
3. The test class should look a lot like the CSV test, except use the right input file name and start endpoint name.



## Logging

You may notice that your tests emit a lot less output all of a sudden. The dependency on POI brought in Log4j and configured commons-logging to use it, so now we need a `log4j.properties` file to configure log output. You can use the attached one (snarfed from ActiveMQ) or write your own; either way save it to `src/main/resources` to ensure you continue to see log output.

**Solution:** Your finished test might look something like this:

- `src/test/java/org/apache/camel/tutorial/ExcellInputTest.java`
- For XML Configuration:
  - `src/test/resources/ExcellInputTest-context.xml`
- Or, for Java DSL Configuration:
  - `src/test/resources/ExcellInputTest-dsl-context.xml`
  - `src/test/java/org/apache/camel/tutorial/routes/ExcellInputTestRoute.java`

## Step 7: Put this all together into Camel routes for the Customer Input

With all the data type conversions working, the next step is to write the real routes that listen for HTTP, FTP, or e-mail input, and write the final XML output to an ActiveMQ queue. Along the way these routes will use the data conversions we've developed above.

So we'll create 3 routes to start with, as shown in the diagram back at the beginning:

1. Accept XML orders over FTP from Customer 1 (we'll assume the FTP server dumps files in a local directory on the Camel machine)
2. Accept CSV orders over HTTP from Customer 2
3. Accept Excel orders via e-mail from Customer 3 (we'll assume the messages are sent to an account we can access via IMAP)

...

## Step 8: Create a unit test for the Customer Input Routes



# Languages Supported Appendix

To support flexible and powerful Enterprise Integration Patterns Camel supports various Languages to create an Expression or Predicate within either the Routing Domain Specific Language or the Xml Configuration. The following languages are supported

## BEAN LANGUAGE

The purpose of the Bean Language is to be able to implement an Expression or Predicate using a simple method on a bean.

So the idea is you specify a bean name which will then be resolved in the Registry such as the Spring ApplicationContext then a method is invoked to evaluate the Expression or Predicate.

If no method name is provided then one is attempted to be chosen using the rules for Bean Binding; using the type of the message body and using any annotations on the bean methods.

The Bean Binding rules are used to bind the Message Exchange to the method parameters; so you can annotate the bean to extract headers or other expressions such as XPath or XQuery from the message.

### Using Bean Expressions from the Java DSL

```
from("activemq:OrdersTopic").  
  filter().method("myBean", "isGoldCustomer").  
  to("activemq:BigSpendersQueue");
```

### Using Bean Expressions from XML

```
<route>  
  <from uri="activemq:OrdersTopic"/>  
  <filter>  
    <method bean="myBean" method="isGoldCustomer"/>  
    <to uri="activemq:BigSpendersQueue"/>  
  </filter>  
</route>
```

### Writing the expression bean

The bean in the above examples is just any old Java Bean with a method called `isGoldCustomer()` that returns some object that is easily converted to a **boolean** value in this case, as its used as a predicate.

So we could implement it like this...

```
public class MyBean {
    public boolean isGoldCustomer(Exchange exchange) {
        ...
    }
}
```

We can also use the Bean Integration annotations. For example you could do...

```
public boolean isGoldCustomer(String body) {...}
```

or

```
public boolean isGoldCustomer(@Header(name = "foo") Integer fooHeader) {...}
```

So you can bind parameters of the method to the Exchange, the Message or individual headers, properties, the body or other expressions.

## Non registry beans

As of Camel 1.5 the Bean Language also supports invoking beans that isn't registered in the Registry. This is usable for quickly to invoke a bean from Java DSL where you don't need to register the bean in the Registry such as the Spring ApplicationContext.

Camel can instantiate the bean and invoke the method if given a class or invoke an already existing instance. This is illustrated from the example below:

```
from("activemq:OrdersTopic").
    filter().expression(bean(MyBean.class, "isGoldCustomer")).
    to("activemq:BigSpendersQueue");
```

The 2nd parameter `isGoldCustomer` is an optional parameter to explicit set the method name to invoke. If not provided Camel will try to invoke the best suited method. If case of ambiguity Camel will thrown an Exception. In these situations the 2nd parameter can solve this problem. Also the code is more readable if the method name is provided. The 1st parameter can also be an existing instance of a Bean such as:

```
private MyBean my;

from("activemq:OrdersTopic").
    filter().expression(bean(my, "isGoldCustomer")).
    to("activemq:BigSpendersQueue");
```

## Other examples

We have some test cases you can look at if it'll help

- `MethodFilterTest` is a JUnit test case showing the Java DSL use of the bean expression being used in a filter
- `aggregator.xml` is a Spring XML test case for the Aggregator which uses a bean method call to test for the completion of the aggregation.

## Dependencies

The Bean language is part of **camel-core**.

## CONSTANT EXPRESSION LANGUAGE

The Constant Expression Language is really just a way to specify constant strings as a type of expression.

**Available as of Camel 1.5**

### Example usage

The `setHeader` element of the Spring DSL can utilize a constant expression like:

```
<route>
  <from uri="seda:a"/>
  <setHeader headerName="theHeader">
    <constant>the value</constant>
  </setHeader>
  <to uri="mock:b"/>
</route>
```

in this case, the Message coming from the `seda:a` Endpoint will have 'theHeader' header set to the constant value 'the value'.

And the same example using Java DSL:

```
from("seda:a").setHeader("theHeader", constant("the value")).to("mock:b");
```

## Dependencies

The Constant language is part of **camel-core**.

## EL

Camel supports the unified JSP and JSF Expression Language via the JUEL to allow an Expression or Predicate to be used in the DSL or Xml Configuration.

For example you could use EL inside a Message Filter in XML

```
<route>
  <from uri="seda:foo"/>
  <filter>
    <el>${in.headers.foo == 'bar'}</el>
    <to uri="seda:bar"/>
  </filter>
</route>
```

You could also use slightly different syntax, e.g. if the header name is not a valid identifier:

```

<route>
  <from uri="seda:foo"/>
  <filter>
    <el>${in.headers['My Header'] == 'bar'}</el>
    <to uri="seda:bar"/>
  </filter>
</route>

```

You could use EL to create an Predicate in a Message Filter or as an Expression for a Recipient List

## Variables

Variable	Type	Description
exchange	Exchange	the Exchange object
in	Message	the exchange.in message
out	Message	the exchange.out message

## Samples

You can use EL dot notation to invoke operations. If you for instance have a body that contains a POJO that has a `getFamilyName` method then you can construct the syntax as follows:

```
"${in.body.familyName}"
```

You have the full power of EL at your hand so you can invoke methods to for instance replace text. In the sample below we replace the text in the body where `id` is replaced with `orderId`.

```

<from uri="seda:incomingOrders">
  <setBody>
    <el>${in.body.replaceAll('id','orderId')}</el>
  </setBody>
  <to uri="seda:processOrder"/>

```

And the sample using the Java DSL:

```
from("seda:incomingOrders").setBody().el("${in.body.replaceAll('id','orderId')}").to("seda:processOrder")
```

## Dependencies

To use EL in your camel routes you need to add the a dependency on **camel-juel** which implements the EL language.

If you use maven you could just add the following to your pom.xml, substituting the version number for the latest & greatest release (see the download page for the latest versions).

```

<dependency>
  <groupId>org.apache.camel</groupId>

```

```
<artifactId>camel-juel</artifactId>
<version>1.4.0</version>
</dependency>
```

## HEADER EXPRESSION LANGUAGE

The Header Expression Language allows you to extract values of named headers.

**Available as of Camel 1.5**

### Example usage

The `recipientList` element of the Spring DSL can utilize a header expression like:

```
<route>
  <from uri="direct:a" />
  <!-- use comma as a delimiter for String based values -->
  <recipientList delimiter=",">
    <header>myHeader</header>
  </recipientList>
</route>
```

In this case, the list of recipients are contained in the header 'myHeader'.

And the same example in Java DSL:

```
from("direct:a").recipientList(header("myHeader"));
```

And with a slightly different syntax where you use the builder to the fullest (i.e. avoid using parameters but using stacked operations, notice that header is not a parameter but a stacked method call)

```
from("direct:a").recipientList().header("myHeader");
```

### Dependencies

The Header language is part of **camel-core**.

## JXPath

Camel supports JXPath to allow XPath expressions to be used on beans in an Expression or Predicate to be used in the DSL or Xml Configuration. For example you could use JXPath to create an Predicate in a Message Filter or as an Expression for a Recipient List.

From 1.3 of Camel onwards you can use XPath expressions directly using smart completion in your IDE as follows

```
from("queue:foo").filter().
  jxpath("/in/body/foo").
  to("queue:bar")
```

## Variables

Variable	Type	Description
this	Exchange	the Exchange object
in	Message	the exchange.in message
out	Message	the exchange.out message

## Using XML configuration

If you prefer to configure your routes in your Spring XML file then you can use XPath expressions as follows

```
<beans xmlns="http://www.springframework.org/schema/beans"
       xmlns:xsi="http://www.w3.org/2001/XMLSchema-instance"
       xsi:schemaLocation="
http://www.springframework.org/schema/beans http://www.springframework.org/
schema/beans/spring-beans-2.0.xsd
http://camel.apache.org/schema/spring http://camel.apache.org/schema/spring/
camel-spring.xsd">

  <camelContext id="camel" xmlns="http://activemq.apache.org/camel/schema/spring">
    <route>
      <from uri="activemq:MyQueue"/>
      <filter>
        <jxpath>in/body/name = 'James'</xpath>
        <to uri="mqseries:SomeOtherQueue"/>
      </filter>
    </route>
  </camelContext>
</beans>
```

## Examples

Here is a simple example using a XPath expression as a predicate in a Message Filter

```
from("direct:start").
  filter().xpath("in/body/name='James'").
  to("mock:result");
```

## JXPath INJECTION

You can use Bean Integration to invoke a method on a bean and use various languages such as XPath to extract a value from the message and bind it to a method parameter.

For example

```
public class Foo {
```

```

    @MessageDriven(uri = "activemq:my.queue")
    public void doSomething(@JXPath("in/body/foo") String correlationID, @Body String
body) {
        // process the inbound message here
    }
}

```

## Dependencies

To use JXPath in your camel routes you need to add the a dependency on **camel-jxpath** which implements the JXPath language.

If you use maven you could just add the following to your pom.xml, substituting the version number for the latest & greatest release (see the download page for the latest versions).

```

<dependency>
  <groupId>org.apache.camel</groupId>
  <artifactId>camel-jxpath</artifactId>
  <version>1.4.0</version>
</dependency>

```

## OGNL

Camel allows OGNL to be used as an Expression or Predicate the DSL or Xml Configuration.

You could use OGNL to create an Predicate in a Message Filter or as an Expression for a Recipient List

You can use OGNL dot notation to invoke operations. If you for instance have a body that contains a POJO that has a `getFamilyName` method then you can construct the syntax as follows:

```

"request.body.familyName"
// or
"getRequest().getBody().getFamilyName()"

```

## Variables

Variable	Type	Description
<b>this</b>	Exchange	the Exchange is the root object
exchange	Exchange	the Exchange object
exception	Throwable	the Exchange exception (if any)
exchangeld	String	the exchange id
fault	Message	the Fault message (if any)
request	Message	the exchange.in message

response	Message	the exchange.out message (if any)
properties	Map	the exchange properties
property(name)	Object	the property by the given name
property(name, type)	Type	the property by the given name as the given type

## Samples

For example you could use OGNL inside a Message Filter in XML

```
<route>
  <from uri="seda:foo"/>
  <filter>
    <ognl>request.headers.foo = 'bar'</ognl>
    <to uri="seda:bar"/>
  </filter>
</route>
```

And the sample using Java DSL:

```
from("seda:foo").filter().ognl("request.headers.foo = 'bar']").to("seda:bar");
```

## Dependencies

To use OGNL in your camel routes you need to add the a dependency on **camel-ognl** which implements the OGNL language.

If you use maven you could just add the following to your pom.xml, substituting the version number for the latest & greatest release (see the download page for the latest versions).

```
<dependency>
  <groupId>org.apache.camel</groupId>
  <artifactId>camel-ognl</artifactId>
  <version>1.4.0</version>
</dependency>
```

## SCRIPTING LANGUAGES

Camel supports a number of scripting languages which can be used to create an Expression or Predicate via the standard JSR 223 which is a standard part of Java 6.

The following scripting languages are integrated into the DSL:

- BeanShell
- JavaScript
- Groovy
- Python
- PHP
- Ruby



However any JSR 223 scripting language can be used using the generic DSL methods.

## ScriptContext

The JSR-223 scripting languages ScriptContext is pre configured with the following attributes all set at `ENGINE_SCOPE`:

Attribute	Type	Value
context	org.apache.camel.CamelContext	The Camel Context
exchange	org.apache.camel.Exchange	The current Exchange
request	org.apache.camel.Message	The IN message
response	org.apache.camel.Message	The OUT message

## Attributes

You can add your own attributes with the `attribute(name, value)` DSL method, such as:

In the sample below we add an attribute `user` that is an object we already have instantiated as `myUser`. This object has a `getFirstName()` method that we want to set as header on the message. We use the groovy language to concat the first and last name into a single string that is returned.

```
from("direct:in").setHeader("name").groovy('$user.firstName
$user.lastName').attribute("user", myUser).to("seda:users");
```

## Any scripting language

Camel can run any JSR-223 scripting languages using the `script` DSL method such as:

```
from("direct:in").setHeader("firstName").script("jaskel",
"user.firstName").attribute("user", myUser).to("seda:users");
```

This is a bit different using the Spring DSL where you use the **expression** element that doesn't support setting attributes (yet):

```
<from uri="direct:in"/>
  <setHeader headerName="firstName">
    <expression language="jaskel">user.firstName</expression>
  </setHeader>
  <to uri="seda:users"/>
```

## Dependencies

To use scripting languages in your camel routes you need to add the a dependency on **camel-script** which integrates the JSR-223 scripting engine.

If you use maven you could just add the following to your pom.xml, substituting the version number for the latest & greatest release (see the download page for the latest versions).

```
<dependency>
  <groupId>org.apache.camel</groupId>
  <artifactId>camel-script</artifactId>
  <version>1.4.0</version>
</dependency>
```

## SEE ALSO

- Languages
- DSL
- Xml Configuration

## BEANSHELL

Camel supports BeanShell among other Scripting Languages to allow an Expression or Predicate to be used in the DSL or Xml Configuration.

To use a BeanShell expression use the following Java code

```
... beanShell("someBeanShellExpression") ...
```

For example you could use the **beanShell** function to create an Predicate in a Message Filter or as an Expression for a Recipient List

## ScriptContext

The JSR-223 scripting languages ScriptContext is pre configured with the following attributes all set at `ENGINE_SCOPE`:

Attribute	Type	Value
context	org.apache.camel.CamelContext	The Camel Context
exchange	org.apache.camel.Exchange	The current Exchange
request	org.apache.camel.Message	The IN message
response	org.apache.camel.Message	The OUT message

## Attributes

You can add your own attributes with the `attribute(name, value)` DSL method, such as:

In the sample below we add an attribute `user` that is an object we already have instantiated as `myUser`. This object has a `getFirstName()` method that we want to set as header on the message. We use the groovy language to concat the first and last name into a single string that is returned.

```
from("direct:in").setHeader("name").groovy("'${user.firstName}
${user.lastName}").attribute("user", myUser).to("seda:users");
```

## Any scripting language

Camel can run any JSR-223 scripting languages using the `script` DSL method such as:

```
from("direct:in").setHeader("firstName").script("jaskel",
"user.firstName").attribute("user", myUser).to("seda:users");
```

This is a bit different using the Spring DSL where you use the **expression** element that doesn't support setting attributes (yet):

```
<from uri="direct:in"/>
  <setHeader headerName="firstName">
    <expression language="jaskel">user.firstName</expression>
  </setHeader>
<to uri="seda:users"/>
```

## Dependencies

To use scripting languages in your camel routes you need to add the a dependency on **camel-script** which integrates the JSR-223 scripting engine.

If you use maven you could just add the following to your pom.xml, substituting the version number for the latest & greatest release (see the download page for the latest versions).

```
<dependency>
  <groupId>org.apache.camel</groupId>
  <artifactId>camel-script</artifactId>
  <version>1.4.0</version>
</dependency>
```

## JAVASCRIPT

Camel supports JavaScript/ECMAScript among other Scripting Languages to allow an Expression or Predicate to be used in the DSL or Xml Configuration.

To use a JavaScript expression use the following java code

```
... javascript("someJavaScriptExpression") ...
```

For example you could use the **javaScript** function to create an Predicate in a Message Filter or as an Expression for a Recipient List

## Example

In the sample below we use JavaScript to create a Predicate use in the route path, to route exchanges from admin users to a special queue.

```
from("direct:start")
    .choice()
        .when().javaScript("request.headers.get('user') ==
'admin'").to("seda:adminQueue")
        .otherwise()
            .to("seda:regularQueue");
```

And a Spring DSL sample as well:

```
<route>
  <from uri="direct:start"/>
  <choice>
    <when>
      <javaScript>request.headers.get('user') == 'admin'</javaScript>
      <to uri="seda:adminQueue"/>
    </when>
    <otherwise>
      <to uri="seda:regularQueue"/>
    </otherwise>
  </choice>
</route>
```

## ScriptContext

The JSR-223 scripting languages ScriptContext is pre configured with the following attributes all set at `ENGINE_SCOPE`:

Attribute	Type	Value
context	org.apache.camel.CamelContext	The Camel Context
exchange	org.apache.camel.Exchange	The current Exchange
request	org.apache.camel.Message	The IN message
response	org.apache.camel.Message	The OUT message

## Attributes

You can add your own attributes with the `attribute(name, value)` DSL method, such as:

In the sample below we add an attribute `user` that is an object we already have instantiated as `myUser`. This object has a `getFirstName()` method that we want to set as header on the message. We use the groovy language to concat the first and last name into a single string that is returned.

```
from("direct:in").setHeader("name").groovy("'${user.firstName}
${user.lastName}").attribute("user", myUser).to("seda:users");
```

## Any scripting language

Camel can run any JSR-223 scripting languages using the `script` DSL method such as:

```
from("direct:in").setHeader("firstName").script("jaskel",
"user.firstName").attribute("user", myUser).to("seda:users");
```

This is a bit different using the Spring DSL where you use the **expression** element that doesn't support setting attributes (yet):

```
<from uri="direct:in"/>
  <setHeader headerName="firstName">
    <expression language="jaskel">user.firstName</expression>
  </setHeader>
  <to uri="seda:users"/>
```

## Dependencies

To use scripting languages in your camel routes you need to add the a dependency on **camel-script** which integrates the JSR-223 scripting engine.

If you use maven you could just add the following to your pom.xml, substituting the version number for the latest & greatest release (see the download page for the latest versions).

```
<dependency>
  <groupId>org.apache.camel</groupId>
  <artifactId>camel-script</artifactId>
  <version>1.4.0</version>
</dependency>
```

## GROOVY

Camel supports Groovy among other Scripting Languages to allow an Expression or Predicate to be used in the DSL or Xml Configuration.

To use a Groovy expression use the following Java code

```
... groovy("someGroovyExpression") ...
```

For example you could use the **groovy** function to create an Predicate in a Message Filter or as an Expression for a Recipient List

## Example

```
// lets route if a line item is over $100
from("queue:foo").filter(groovy("request.lineItems.any { i -> i.value > 100
}")).to("queue:bar")
```

And the Spring DSL:

```
<route>
  <from uri="queue:foo" />
  <filter>
    <groovy>request.lineItems.any { i -> i.value > 100 }</groovy>
    <to uri="queue:bar" />
  </filter>
</route>
```

## ScriptContext

The JSR-223 scripting languages ScriptContext is pre configured with the following attributes all set at `ENGINE_SCOPE`:

Attribute	Type	Value
context	org.apache.camel.CamelContext	The Camel Context
exchange	org.apache.camel.Exchange	The current Exchange
request	org.apache.camel.Message	The IN message
response	org.apache.camel.Message	The OUT message

## Attributes

You can add your own attributes with the `attribute(name, value)` DSL method, such as:

In the sample below we add an attribute `user` that is an object we already have instantiated as `myUser`. This object has a `getFirstName()` method that we want to set as header on the message. We use the groovy language to concat the first and last name into a single string that is returned.

```
from("direct:in").setHeader("name").groovy("'${user.firstName}
${user.lastName}").attribute("user", myUser).to("seda:users");
```

## Any scripting language

Camel can run any JSR-223 scripting languages using the `script` DSL method such as:

```
from("direct:in").setHeader("firstName").script("jaskel",
"user.firstName").attribute("user", myUser).to("seda:users");
```

This is a bit different using the Spring DSL where you use the **expression** element that doesn't support setting attributes (yet):

```
<from uri="direct:in" />
  <setHeader headerName="firstName">
    <expression language="jaskel">user.firstName</expression>
```

```
</setHeader>
<to uri="seda:users"/>
```

## Dependencies

To use scripting languages in your camel routes you need to add the a dependency on **camel-script** which integrates the JSR-223 scripting engine.

If you use maven you could just add the following to your pom.xml, substituting the version number for the latest & greatest release (see the download page for the latest versions).

```
<dependency>
  <groupId>org.apache.camel</groupId>
  <artifactId>camel-script</artifactId>
  <version>1.4.0</version>
</dependency>
```

## PYTHON

Camel supports Python among other Scripting Languages to allow an Expression or Predicate to be used in the DSL or Xml Configuration.

To use a Python expression use the following Java code

```
... python("somePythonExpression") ...
```

For example you could use the **python** function to create an Predicate in a Message Filter or as an Expression for a Recipient List

## Example

In the sample below we use Python to create a Predicate use in the route path, to route exchanges from admin users to a special queue.

```
from("direct:start")
  .choice()
    .when().python("request.headers['user'] == 'admin'").to("seda:adminQueue")
    .otherwise()
      .to("seda:regularQueue");
```

And a Spring DSL sample as well:

```
<route>
  <from uri="direct:start"/>
  <choice>
    <when>
      <python>request.headers['user'] == 'admin'</python>
      <to uri="seda:adminQueue"/>
    </when>
    <otherwise>
      <to uri="seda:regularQueue"/>
    </otherwise>
  </choice>
</route>
```

```
</choice>
</route>
```

## ScriptContext

The JSR-223 scripting languages ScriptContext is pre configured with the following attributes all set at `ENGINE_SCOPE`:

Attribute	Type	Value
context	org.apache.camel.CamelContext	The Camel Context
exchange	org.apache.camel.Exchange	The current Exchange
request	org.apache.camel.Message	The IN message
response	org.apache.camel.Message	The OUT message

## Attributes

You can add your own attributes with the `attribute(name, value)` DSL method, such as:

In the sample below we add an attribute `user` that is an object we already have instantiated as `myUser`. This object has a `getFirstName()` method that we want to set as header on the message. We use the groovy language to concat the first and last name into a single string that is returned.

```
from("direct:in").setHeader("name").groovy("'${user.firstName}
${user.lastName}").attribute("user", myUser).to("seda:users");
```

## Any scripting language

Camel can run any JSR-223 scripting languages using the `script` DSL method such as:

```
from("direct:in").setHeader("firstName").script("jaskel",
"user.firstName").attribute("user", myUser).to("seda:users");
```

This is a bit different using the Spring DSL where you use the **expression** element that doesn't support setting attributes (yet):

```
<from uri="direct:in"/>
  <setHeader headerName="firstName">
    <expression language="jaskel">user.firstName</expression>
  </setHeader>
  <to uri="seda:users"/>
```



## Dependencies

To use scripting languages in your camel routes you need to add the a dependency on **camel-script** which integrates the JSR-223 scripting engine.

If you use maven you could just add the following to your pom.xml, substituting the version number for the latest & greatest release (see the download page for the latest versions).

```
<dependency>
  <groupId>org.apache.camel</groupId>
  <artifactId>camel-script</artifactId>
  <version>1.4.0</version>
</dependency>
```

## PHP

Camel supports PHP among other Scripting Languages to allow an Expression or Predicate to be used in the DSL or Xml Configuration.

To use a PHP expression use the following Java code

```
... php( "somePHPExpression" ) ...
```

For example you could use the **php** function to create an Predicate in a Message Filter or as an Expression for a Recipient List

## ScriptContext

The JSR-223 scripting languages ScriptContext is pre configured with the following attributes all set at `ENGINE_SCOPE`:

Attribute	Type	Value
context	<code>org.apache.camel.CamelContext</code>	The Camel Context
exchange	<code>org.apache.camel.Exchange</code>	The current Exchange
request	<code>org.apache.camel.Message</code>	The IN message
response	<code>org.apache.camel.Message</code>	The OUT message

## Attributes

You can add your own attributes with the `attribute(name, value)` DSL method, such as:

In the sample below we add an attribute `user` that is an object we already have instantiated as `myUser`. This object has a `getFirstName()` method that we want to set as header on the message. We use the groovy language to concat the first and last name into a single string that is returned.

```
from("direct:in").setHeader("name").groovy("'${user.firstName}
${user.lastName}").attribute("user", myUser).to("seda:users");
```

## Any scripting language

Camel can run any JSR-223 scripting languages using the `script` DSL method such as:

```
from("direct:in").setHeader("firstName").script("jaskel",
"user.firstName").attribute("user", myUser).to("seda:users");
```

This is a bit different using the Spring DSL where you use the **expression** element that doesn't support setting attributes (yet):

```
<from uri="direct:in"/>
  <setHeader headerName="firstName">
    <expression language="jaskel">user.firstName</expression>
  </setHeader>
<to uri="seda:users"/>
```

## Dependencies

To use scripting languages in your camel routes you need to add the a dependency on **camel-script** which integrates the JSR-223 scripting engine.

If you use maven you could just add the following to your pom.xml, substituting the version number for the latest & greatest release (see the download page for the latest versions).

```
<dependency>
  <groupId>org.apache.camel</groupId>
  <artifactId>camel-script</artifactId>
  <version>1.4.0</version>
</dependency>
```

## RUBY

Camel supports Ruby among other Scripting Languages to allow an Expression or Predicate to be used in the DSL or Xml Configuration.

To use a Ruby expression use the following Java code

```
... ruby("someRubyExpression") ...
```

For example you could use the **ruby** function to create an Predicate in a Message Filter or as an Expression for a Recipient List

## Example

In the sample below we use Ruby to create a Predicate use in the route path, to route exchanges from admin users to a special queue.

```

from("direct:start")
  .choice()
    .when().ruby("$request.headers['user'] == 'admin'").to("seda:adminQueue")
    .otherwise()
      .to("seda:regularQueue");

```

And a Spring DSL sample as well:

```

<route>
  <from uri="direct:start"/>
  <choice>
    <when>
      <ruby>$request.headers['user'] == 'admin'</ruby>
      <to uri="seda:adminQueue"/>
    </when>
    <otherwise>
      <to uri="seda:regularQueue"/>
    </otherwise>
  </choice>
</route>

```

## ScriptContext

The JSR-223 scripting languages ScriptContext is pre configured with the following attributes all set at `ENGINE_SCOPE`:

Attribute	Type	Value
context	org.apache.camel.CamelContext	The Camel Context
exchange	org.apache.camel.Exchange	The current Exchange
request	org.apache.camel.Message	The IN message
response	org.apache.camel.Message	The OUT message

## Attributes

You can add your own attributes with the `attribute(name, value)` DSL method, such as:

In the sample below we add an attribute `user` that is an object we already have instantiated as `myUser`. This object has a `getFirstName()` method that we want to set as header on the message. We use the groovy language to concat the first and last name into a single string that is returned.

```

from("direct:in").setHeader("name").groovy("'${user.firstName}
${user.lastName}').attribute("user", myUser).to("seda:users");

```

## Any scripting language

Camel can run any JSR-223 scripting languages using the `script` DSL method such as:

```
from("direct:in").setHeader("firstName").script("jaskel",
"user.firstName").attribute("user", myUser).to("seda:users");
```

This is a bit different using the Spring DSL where you use the **expression** element that doesn't support setting attributes (yet):

```
<from uri="direct:in"/>
  <setHeader headerName="firstName">
    <expression language="jaskel">user.firstName</expression>
  </setHeader>
  <to uri="seda:users"/>
```

## Dependencies

To use scripting languages in your camel routes you need to add the a dependency on **camel-script** which integrates the JSR-223 scripting engine.

If you use maven you could just add the following to your pom.xml, substituting the version number for the latest & greatest release (see the download page for the latest versions).

```
<dependency>
  <groupId>org.apache.camel</groupId>
  <artifactId>camel-script</artifactId>
  <version>1.4.0</version>
</dependency>
```

## SIMPLE EXPRESSION LANGUAGE

The Simple Expression Language is a really simple language you can use. Its primarily intended for being a really small and simple language for testing without requiring any new dependencies or knowledge of XPath; so its ideal for testing in camel-core. However for real world use cases you are generally recommended to choose a more expressive and powerful language such as:

- Bean Language
- EL
- OGNL
- one of the supported Scripting Languages

The simple language uses `${body}` placeholders for complex expressions where the expression contains constant literals. The `#{ }` placeholders can be omitted if the expression is only the token itself.

To get the body of the in message: `"body"`, or `"in.body"` or `"${body}"`.

A complex expression must use `#{ }` placeholders, such as: `"Hello ${in.header.name} how are you?"`.

You can have multiple tokens in the same expression: "Hello `${in.header.name}` this is `${in.header.me}` speaking". However you can **not** nest tokens (i.e. having another `${ }` placeholder in an existing, is not allowed).

## Variables

Variable	Type	Description
id	String	the input message id
body	Object	the input body
in.body	Object	the input body
out.body	Object	the output body
header.foo	Object	refer to the input foo header
headers.foo	Object	refer to the input foo header
in.header.foo	Object	refer to the input foo header
in.headers.foo	Object	refer to the input foo header
out.header.foo	Object	refer to the out header foo
out.headers.foo	Object	refer to the out header foo
property.foo	Object	refer to the foo property on the exchange
sys.foo	String	refer to the system property
exception.message	String	<b>New in Camel 2.0.</b> Refer to the exception.message on the exchange, is <code>&lt;tt&gt;null&lt;/tt&gt;</code> if no exception set on exchange
date:command:pattern	String	<b>New in Camel 1.5.</b> Date formatting using the <code>java.text.SimpleDateFormat</code> patterns. Supported commands are: <b>now</b> for current timestamp, <b>in.header.xxx</b> or <b>header.xxx</b> to use the Date object in the IN header with the key xxx. <b>out.header.xxx</b> to use the Date object in the OUT header with the key xxx.
bean:bean expression	Object	<b>New in Camel 1.5.</b> Invoking a bean expression using the Bean language.

## Samples

In the Spring XML sample below we filter based on a header value:

```
<from uri="seda:orders">
  <filter>
    <simple>in.header.foo</simple>
    <to uri="mock:fooOrders" />
  </filter>
</from>
```

The Simple language can be used for the predicate test above in the Message Filter pattern, where we test if the in message has a foo header (a header with the key foo exists). If the expression evaluates to **true** then the message is routed to the mock:foo endpoint, otherwise its lost in the deep blue sea 😊.

The same example in Java DSL:

```
from("seda:orders")
  .filter().simple("in.header.foo").to("seda:fooOrders");
```

You can also use the simple language for simple text concatenations such as:

```
from("direct:hello").transform().simple("Hello ${in.header.user} how are you?").to("mock:reply");
```

Notice that we must use `${ }` placeholders in the expression now to let Camel be able to parse it correctly.

And this sample uses the date command to output current date.

```
from("direct:hello").transform().simple("The today is ${date:now:yyyyMMdd} and its a great day.").to("mock:reply");
```

And in the sample below we invoke the bean language to invoke a method on a bean to be included in the returned string:

```
from("direct:order").transform().simple("OrderId: ${bean:orderIdGenerator}").to("mock:reply");
```

Where `orderIdGenerator` is the id of the bean registered in the Registry. If using Spring then its the Spring bean id.

## Dependencies

The Bean language is part of **camel-core**.

## FILE EXPRESSION LANGUAGE

### Available as of Camel 1.5

The File Expression Language is an extension to the Simple language, adding file related capabilities. These capabilities is related to common use cases working with file path and names. The goal is to allow expression to be used with the File and FTP components for setting dynamic file patterns for both consumer and producer.

## Syntax

This language is an **extension** to the Simple language so the Simple syntax applies also. So the table below only lists the additional.

As opposed to Simple language File Language also supports Constant expressions so you can enter a fixed filename.

All the file tokens uses the same expression name as the method on the `java.io.File` object, for instance `file:absolute` refers to the `java.io.File.getAbsolute()` method. Notice that not all expressions is supported by the current Exchange. For instance the FTP component only supports a few of the options, where as the File component support all of them.

Expression	Type	File Consumer	File Producer	FTP Consumer	FTP Producer	Description
<code>filename</code>	String	yes	no	yes	no	refers to the file name
<code>filename.ext</code>	String	yes	no	yes	no	Camel 2.0: refers to the file extension only
<code>filename.noext</code>	String	yes	no	yes	no	refers to the file name with no extension
<code>file:parent</code>	String	yes	no	yes	no	refers to the file parent
<code>file:path</code>	String	yes	no	yes	no	refers to the file path
<code>file:absolute.path</code>	String	yes	no	no	no	refers to the absolute file path
<code>file:canonical.path</code>	String	yes	no	no	no	refers to the canonical path
<code>file:length</code>	Long	yes	no	yes	no	refers to the file length returned as a Long type
<code>file:modified</code>	Date	yes	no	yes	no	Camel 2.0: refers to the file last modified returned as a Date type
<code>date:command:pattern</code>	String	yes	yes	yes	yes	for date formatting using the <code>java.text.SimpleDateFormat</code> patterns. Is an <b>extension</b> to the Simple language. Additional command is: <b>file</b> (consumers only) for the last modified timestamp of the file. Notice: all the commands from the Simple language can also be used.

## File token example

We have a `java.io.File` handle for the file `hello.txt` in the following directory: `D:\project\camel\camel-core\target\filelanguage`. The file tokens will return as:

Expression	Returns
<code>file:name</code>	<code>hello.txt</code>
<code>file:name.ext</code>	<code>txt</code>
<code>file:name.noext</code>	<code>hello</code>
<code>file:parent</code>	<code>target\filelanguage</code>
<code>file:path</code>	<code>target\filelanguage\hello.txt</code>
<code>file:absolute.path</code>	<code>D:\project\camel\camel-core\target\filelanguage\hello.txt</code>

file:canonical.path D:\project\camel\camel-core\target\filelanguage\hello.txt

---

## Samples

You can enter a fixed Constant expression such as `myfile.txt`:

```
expression="myfile.txt"
```

Lets assume we use the file consumer to read files and want to move the read files to backup folder with the current date as a sub folder. This can be archived using an expression like:

```
expression="backup/${date:now:yyyyMMdd}/${file:name.noext}.bak"
```

relative folder names is also supported so suppose the backup folder should be a sibling folder then you can append `..` as:

```
expression=" ../backup/${date:now:yyyyMMdd}/${file:name.noext}.bak"
```

As this is an extension to the Simple language we have access to all the goodies from this language also, so in this use case we want to use the `in.header.type` as a parameter in the dynamic expression:

```
expression=" ../backup/${date:now:yyyyMMdd}/type-${in.header.type}/  
backup-of-${file:name.noext}.bak"
```

If you have a custom Date you want to use in the expression then Camel supports retrieving dates from the message header.

```
expression="orders/  
order-${in.header.customerId}-${date:in.header.orderDate:yyyyMMdd}.xml"
```

And finally we can also use a bean expression to invoke a POJO class that generates some String output (or convertible to String) to be used:

```
expression="uniquefile-${bean:myguidgenerator.generateid}.txt"
```

And of course all this can be combined in one expression where you can use the File Language, Simple and the Bean language in one combined expression. This is pretty powerful for those common file path patterns.

## Dependencies

The File language is part of **camel-core**.

## SQL

The SQL support is added by JoSQL and is primarily used for performing SQL queries on in-memory objects. If you prefer to perform actual database queries then check out the JPA component.



Camel supports SQL to allow an Expression or Predicate to be used in the DSL or Xml Configuration. For example you could use SQL to create an Predicate in a Message Filter or as an Expression for a Recipient List.

```
from("queue:foo").setBody().sql("select * from MyType").to("queue:bar")
```

And the spring DSL:

```
<from uri="queue:foo" />
  <setBody>
    <sql>select * from MyType</sql>
  </setBody>
<to uri="queue:bar" />
```

## Variables

Variable	Type	Description
exchange	Exchange	the Exchange object
in	Message	the exchange.in message
out	Message	the exchange.out message
the property key	Object	the Exchange properties
the header key	Object	the exchange.in headers
the variable key	Object	if any additional variables is added using <code>setVariables</code> method

## Dependencies

To use SQL in your camel routes you need to add the a dependency on **camel-josql** which implements the SQL language.

If you use maven you could just add the following to your pom.xml, substituting the version number for the latest & greatest release (see the download page for the latest versions).

```
<dependency>
  <groupId>org.apache.camel</groupId>
  <artifactId>camel-josql</artifactId>
  <version>1.4.0</version>
</dependency>
```

## XPATH

Camel supports XPath to allow an Expression or Predicate to be used in the DSL or Xml Configuration. For example you could use XPath to create an Predicate in a Message Filter or as an Expression for a Recipient List.

```
from("queue:foo").
  filter().xpath("//foo").
  to("queue:bar");
```

```
from("queue:foo").
  choice().xpath("//foo").to("queue:bar").
  otherwise().to("queue:others");
```

## Namespaces

In 1.3 onwards you can easily use namespaces with XPath expressions using the Namespaces helper class.

```
Namespaces ns = new Namespaces("c", "http://acme.com/cheese");

from("direct:start").filter().
  xpath("/c:person[@name='James']", ns).
  to("mock:result");
```

## Variables

Variables in XPath is defined in different namespaces. The default namespace is `http://camel.apache.org/schema/spring`.

Namespace URI	Local part	Type	Description
<code>http://camel.apache.org/xml/in/</code>	in	Message	the exchange.in message
<code>http://camel.apache.org/xml/out/</code>	out	Message	the exchange.out message
<code>http://camel.apache.org/xml/variables/environment-variables</code>	env	Object	OS environment variables
<code>http://camel.apache.org/xml/variables/system-properties</code>	system	Object	Java System properties
<code>http://camel.apache.org/xml/variables/exchange-property</code>		Object	the exchange property

Camel will resolve variables according to either:

- namespace given
- no namespace given

## Namespace given

If the namespace is given then Camel is instructed exactly what to return. However when resolving either **in** or **out** Camel will try to resolve a header with the given local part first, and return it. If the local part has the value **body** then the body is returned instead.

## No namespace given

If there is no namespace given then Camel resolves only based on the local part. Camel will try to resolve a variable in the following steps:

- from variables that has been set using the `variable(name, value)` fluent builder
- from `message.in.header` if there is a header with the given key
- from `exchange.properties` if there is a property with the given key

## Functions

Camel adds the following XPath functions that can be used to access the exchange:

Function	Argument	Type	Description
<code>in:body</code>	none	Object	Will return the <b>in</b> message body.
<code>in:header</code>	the header name	Object	Will return the <b>in</b> message header.
<code>out:body</code>	none	Object	Will return the <b>out</b> message body.
<code>out:header</code>	the header name	Object	Will return the <b>out</b> message header.

Here's an example showing some of these functions in use.

```
from("direct:start").choice()  
  .when().xpath("in:header('foo') = 'bar'").to("mock:x")  
  .when().xpath("in:body() = '<two/>'").to("mock:y")  
  .otherwise().to("mock:z");
```

## Using XML configuration

If you prefer to configure your routes in your Spring XML file then you can use XPath expressions as follows

```
<beans xmlns="http://www.springframework.org/schema/beans"  
  xmlns:xsi="http://www.w3.org/2001/XMLSchema-instance"  
  xmlns:foo="http://example.com/person"  
  xsi:schemaLocation="  
    http://www.springframework.org/schema/beans http://www.springframework.org/  
    schema/beans/spring-beans-2.0.xsd  
    http://camel.apache.org/schema/spring http://camel.apache.org/schema/spring/  
    camel-spring.xsd">
```

```

<camelContext id="camel" xmlns="http://activemq.apache.org/camel/schema/spring">
  <route>
    <from uri="activemq:MyQueue"/>
    <filter>
      <xpath>/foo:person[@name='James ']/</xpath>
      <to uri="mqseries:SomeOtherQueue"/>
    </filter>
  </route>
</camelContext>
</beans>

```

Notice how we can reuse the namespace prefixes, **foo** in this case, in the XPath expression for easier namespace based XPath expressions!

## Examples

Here is a simple example using an XPath expression as a predicate in a Message Filter

```

from("direct:start").
  filter().xpath("/person[@name='James']").
  to("mock:result");

```

If you have a standard set of namespaces you wish to work with and wish to share them across many different XPath expressions you can use the NamespaceBuilder as shown in this example

```

// lets define the namespaces we'll need in our filters
Namespaces ns = new Namespaces("c", "http://acme.com/cheese")
  .add("xsd", "http://www.w3.org/2001/XMLSchema");

// now lets create an xpath based Message Filter
from("direct:start").
  filter(ns.xpath("/c:person[@name='James']")).
  to("mock:result");

```

In this sample we have a choice construct. The first choice evaluates if the message has a header key **type** that has the value **Camel**.

The 2nd choice evaluates if the message body has a name tag **<name>** which values is **Kong**. If neither is true the message is routed in the otherwise block:

```

from("direct:in").choice()
  // using $headerName is special notation in Camel to get the header key
  .when().xpath("$type = 'Camel'")
  .to("mock:camel")
  // here we test for the body name tag
  .when().xpath("//name = 'Kong'")
  .to("mock:donkey")
  .otherwise()
  .to("mock:other")
  .end();

```

And the spring XML equivalent of the route:

```

<camelContext id="camel" xmlns="http://camel.apache.org/schema/spring">
  <route>

```

```

<from uri="direct:in"/>
<choice>
  <when>
    <xpath>$type = 'Camel'</xpath>
    <to uri="mock:camel"/>
  </when>
  <when>
    <xpath>//name = 'Kong'</xpath>
    <to uri="mock:donkey"/>
  </when>
  <otherwise>
    <to uri="mock:other"/>
  </otherwise>
</choice>
</route>
</camelContext>

```

## XPATH INJECTION

You can use Bean Integration to invoke a method on a bean and use various languages such as XPath to extract a value from the message and bind it to a method parameter.

The default XPath annotation has SOAP and XML namespaces available. If you want to use your own namespace URIs in an XPath expression you can use your own copy of the XPath annotation to create whatever namespace prefixes you want to use.

i.e. cut and paste the XPath annotation code to your own project in a different package and/or annotation name then add whatever namespace prefix/uris you want in scope when you use your annotation on a method parameter. Then when you use your annotation on a method parameter all the namespaces you want will be available for use in your XPath expression.

For example

```

public class Foo {
    @MessageDriven(uri = "activemq:my.queue")
    public void doSomething(@Path("/foo/bar/text()") String correlationID, @Body
String body) {
        // process the inbound message here
    }
}

```

## Dependencies

The XPath language is part of camel-core.

## XQUERY

Camel supports XQuery to allow an Expression or Predicate to be used in the DSL or Xml Configuration. For example you could use XQuery to create an Predicate in a Message Filter or as an Expression for a Recipient List.

```
from("queue:foo").filter().
  xquery("//foo").
  to("queue:bar")
```

You can also use functions inside your query, in which case you need an explicit type conversion (or you will get a `org.w3c.dom.DOMException: HIERARCHY_REQUEST_ERR`) by passing the Class as a second argument to the `xquery()` method.

```
from("direct:start").
  recipientList().xquery("concat('mock:foo.', /person/@city)", String.class);
```

### Variables

The IN message body will be set as the `contextItem`. Besides this these Variables is also added as parameters:

Variable	Type	Description
exchange	Exchange	The current Exchange
out	Message	The OUT message (if any)
key name	Object	Any exchange.properties and exchange.in.headers and any additional parameters set using <code>setParameters(Map)</code> . These parameters is added with they own key name, for instance if there is an IN header with the key name <b>foo</b> then its added as <b>foo</b> .

### Using XML configuration

If you prefer to configure your routes in your Spring XML file then you can use XPath expressions as follows

```
<beans xmlns="http://www.springframework.org/schema/beans"
  xmlns:xsi="http://www.w3.org/2001/XMLSchema-instance"
  xmlns:foo="http://example.com/person"
  xsi:schemaLocation="
    http://www.springframework.org/schema/beans http://www.springframework.org/
    schema/beans/spring-beans-2.0.xsd
    http://camel.apache.org/schema/spring http://camel.apache.org/schema/spring/
    camel-spring.xsd">

  <camelContext id="camel" xmlns="http://activemq.apache.org/camel/schema/spring">
    <route>
      <from uri="activemq:MyQueue"/>
      <filter>
```

```

    <xquery>/foo:person[@name='James']</xquery>
    <to uri="mqseries:SomeOtherQueue"/>
  </filter>
</route>
</camelContext>
</beans>

```

Notice how we can reuse the namespace prefixes, **foo** in this case, in the XPath expression for easier namespace based XQuery expressions!

When you use functions in your XQuery expression you need an explicit type conversion which is done in the xml configuration via the **@type** attribute:

```

<xquery type="java.lang.String">concat('mock:foo.', /person/@city)</xquery>

```

## Using XQuery as an endpoint

Sometimes an XQuery expression can be quite large; it can essentially be used for Templating. So you may want to use an XQuery Endpoint so you can route using XQuery templates.

The following example shows how to take a message of an ActiveMQ queue (MyQueue) and transform it using XQuery and send it to MQSeries.

```

<camelContext id="camel" xmlns="http://camel.apache.org/schema/spring">
  <route>
    <from uri="activemq:MyQueue"/>
    <to uri="xquery:com/acme/someTransform.xquery"/>
    <to uri="mqseries:SomeOtherQueue"/>
  </route>
</camelContext>

```

## Examples

Here is a simple example using an XQuery expression as a predicate in a Message Filter

```

from("direct:start").filter().xquery("/person[@name='James']").to("mock:result");

```

This example uses XQuery with namespaces as a predicate in a Message Filter

```

Namespaces ns = new Namespaces("c", "http://acme.com/cheese");

from("direct:start").
  filter().xquery("/c:person[@name='James']", ns).
  to("mock:result");

```

## Learning XQuery

XQuery is a very powerful language for querying, searching, sorting and returning XML. For help learning XQuery try these tutorials

- Mike Kay's XQuery Primer
- the W3Schools XQuery Tutorial

You might also find the XQuery function reference useful

## Dependencies

To use XQuery in your camel routes you need to add the a dependency on **camel-saxon** which implements the XQuery language.

If you use maven you could just add the following to your pom.xml, substituting the version number for the latest & greatest release (see the download page for the latest versions).

```
<dependency>
  <groupId>org.apache.camel</groupId>
  <artifactId>camel-saxon</artifactId>
  <version>1.4.0</version>
</dependency>
```



# Pattern Appendix

There now follows a breakdown of the various Enterprise Integration Patterns that Camel supports

## MESSAGING SYSTEMS

### Message Channel

Camel supports the Message Channel from the EIP patterns. The Message Channel is an internal implementation detail of the Endpoint interface and all interactions with the Message Channel are via the Endpoint interfaces.

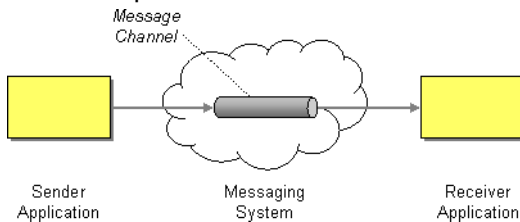

For more details see

- Message
- Message Endpoint

### Using This Pattern

If you would like to use this EIP Pattern then please read the Getting Started, you may also find the Architecture useful particularly the description of Endpoint and URIs. Then you could try out some of the Examples first before trying this pattern out.

### Message

Camel supports the Message from the EIP patterns using the Message interface.

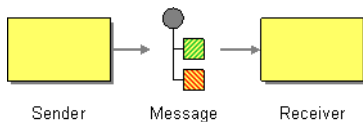

To support various message exchange patterns like one way Event Message and [Request Response] messages Camel uses an Exchange interface which has a **pattern** property which can be set to **InOnly** for an Event Message which has a single inbound Message, or **InOut** for a Request Reply where there is an inbound and outbound message.

## Using This Pattern

If you would like to use this EIP Pattern then please read the Getting Started, you may also find the Architecture useful particularly the description of Endpoint and URIs. Then you could try out some of the Examples first before trying this pattern out.

## Pipes and Filters

Camel supports the Pipes and Filters from the EIP patterns in various ways.



With Camel you can split your processing across multiple independent Endpoint instances which can then be chained together.

## Using Routing Logic

You can create pipelines of logic using multiple Endpoint or Message Translator instances as follows

```
from("direct:a").pipeline("direct:x", "direct:y", "direct:z", "mock:result");
```

Though pipeline is the default mode of operation when you specify multiple outputs in Camel. The opposite to pipeline is multicast; which fires the same message into each of its outputs. (See the example below).

In Spring XML you can use the `<pipeline/>` element as of 1.4.0 onwards

```
<route>
  <from uri="activemq:SomeQueue" />
  <pipeline>
    <bean ref="foo" />
    <bean ref="bar" />
    <to uri="activemq:OutputQueue" />
  </pipeline>
</route>
```

In the above the pipeline element is actually unnecessary, you could use this...

```
<route>
  <from uri="activemq:SomeQueue" />
  <bean ref="foo" />
  <bean ref="bar" />
  <to uri="activemq:OutputQueue" />
</route>
```

Its just a bit more explicit. However if you wish to use `<multicast/>` to avoid a pipeline - to send the same message into multiple pipelines - then the `<pipeline/>` element comes into its own.

```
<route>
  <from uri="activemq:SomeQueue" />
  <multicast>
    <pipeline>
      <bean ref="something" />
      <to uri="log:Something" />
    </pipeline>
    <pipeline>
      <bean ref="foo" />
      <bean ref="bar" />
      <to uri="activemq:OutputQueue" />
    </pipeline>
  </multicast>
</route>
```

In the above example we are routing from a single Endpoint to a list of different endpoints specified using URIs. If you find the above a bit confusing, try reading about the Architecture or try the Examples

## Using This Pattern

If you would like to use this EIP Pattern then please read the Getting Started, you may also find the Architecture useful particularly the description of Endpoint and URIs. Then you could try out some of the Examples first before trying this pattern out.

## Message Router

The Message Router from the EIP patterns allows you to consume from an input destination, evaluate some predicate then choose the right output destination.

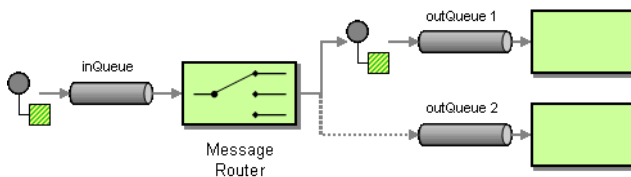

The following example shows how to route a request from an input **queue:a** endpoint to either **queue:b**, **queue:c** or **queue:d** depending on the evaluation of various Predicate expressions

### Using the Fluent Builders

```
RouteBuilder builder = new RouteBuilder() {
    public void configure() {
        from("seda:a").choice().when(header("foo").isEqualTo("bar")).to("seda:b")

        .when(header("foo").isEqualTo("cheese")).to("seda:c").otherwise().to("seda:d");
    }
};
```

### Using the Spring XML Extensions

```
<camelContext id="camel" xmlns="http://camel.apache.org/schema/spring">
  <route>
    <from uri="seda:a"/>
    <choice>
      <when>
        <xpath>$foo = 'bar'</xpath>
        <to uri="seda:b"/>
      </when>
      <when>
        <xpath>$foo = 'cheese'</xpath>
        <to uri="seda:c"/>
      </when>
      <otherwise>
        <to uri="seda:d"/>
      </otherwise>
    </choice>
  </route>
</camelContext>
```

### Choice without otherwise

If you use a choice without adding an otherwise, any unmatched exchanges will be dropped by default. If you prefer to have an exception for an unmatched exchange, you can add a `throwFault` to the otherwise.

```
...otherwise().throwFault("No matching when clause found on choice block");
```

### Using This Pattern

If you would like to use this EIP Pattern then please read the Getting Started, you may also find the Architecture useful particularly the description of Endpoint and URIs. Then you could try out some of the Examples first before trying this pattern out.

## Message Translator

Camel supports the Message Translator from the EIP patterns by using an arbitrary Processor in the routing logic, by using a bean to perform the transformation, or by using `transform()` in the DSL. You can also use a Data Format to marshal and unmarshal messages in different encodings.

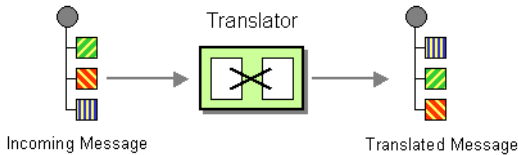

### Using the Fluent Builders

You can transform a message using Camel's Bean Integration to call any method on a bean in your Registry such as your Spring XML configuration file as follows

```
from("activemq:SomeQueue").
  beanRef("myTransformerBean", "myMethodName").
  to("mqseries:AnotherQueue");
```

Where the "myTransformerBean" would be defined in a Spring XML file or defined in JNDI etc. You can omit the method name parameter from `beanRef()` and the Bean Integration will try to deduce the method to invoke from the message exchange.

or you can add your own explicit Processor to do the transformation

```
from("direct:start").process(new Processor() {
  public void process(Exchange exchange) {
    Message in = exchange.getIn();
    in.setBody(in.getBody(String.class) + " World!");
  }
}).to("mock:result");
```

or you can use the DSL to explicitly configure the transformation

```
from("direct:start").transform(body().append(" World!")).to("mock:result");
```

### Use Spring XML

You can also use Spring XML Extensions to do a transformation. Basically any Expression language can be substituted inside the transform element as shown below

```
<camelContext xmlns="http://camel.apache.org/schema/spring">
  <route>
    <from uri="direct:start"/>
    <transform>
      <simple>${in.body} extra data!</simple>
    </transform>
    <to uri="mock:end"/>
  </route>
</camelContext>
```

Or you can use the Bean Integration to invoke a bean

```

<route>
  <from uri="activemq:Input" />
  <bean ref="myBeanName" method="doTransform" />
  <to uri="activemq:Output" />
</route>

```

You can also use Templating to consume a message from one destination, transform it with something like Velocity or XQuery and then send it on to another destination. For example using InOnly (one way messaging)

```

from("activemq:My.Queue").
  to("velocity:com/acme/MyResponse.vm").
  to("activemq:Another.Queue");

```

If you want to use InOut (request-reply) semantics to process requests on the **My.Queue** queue on ActiveMQ with a template generated response, then sending responses back to the JMSReplyTo Destination you could use this.

```

from("activemq:My.Queue").
  to("velocity:com/acme/MyResponse.vm");

```

For further examples of this pattern in use you could look at one of the JUnit tests

- TransformTest
- TransformViaDSLTest
- TransformProcessorTest
- TransformWithExpressionTest (test resource)

## Using This Pattern

If you would like to use this EIP Pattern then please read the Getting Started, you may also find the Architecture useful particularly the description of Endpoint and URIs. Then you could try out some of the Examples first before trying this pattern out.

### Message Endpoint

Camel supports the Message Endpoint from the EIP patterns using the Endpoint interface.

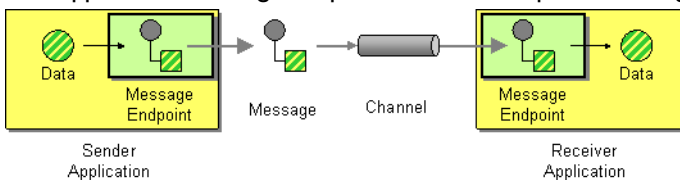

When using the DSL to create Routes you typically refer to Message Endpoints by their URIs rather than directly using the Endpoint interface. Its then a responsibility of the CamelContext to create and activate the necessary Endpoint instances using the available Component implementations.

For more details see

- Message

## Using This Pattern

If you would like to use this EIP Pattern then please read the [Getting Started](#), you may also find the [Architecture](#) useful particularly the description of Endpoint and URIs. Then you could try out some of the [Examples](#) first before trying this pattern out.

## MESSAGING CHANNELS

### Point to Point Channel

Camel supports the Point to Point Channel from the EIP patterns using the following components

- Queue for in-VM seda based messaging
- JMS for working with JMS Queues for high performance, clustering and load balancing
- JPA for using a database as a simple message queue
- XMPP for point-to-point communication over XMPP (Jabber)

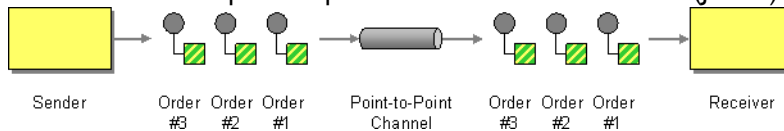

## Using This Pattern

If you would like to use this EIP Pattern then please read the [Getting Started](#), you may also find the [Architecture](#) useful particularly the description of Endpoint and URIs. Then you could try out some of the [Examples](#) first before trying this pattern out.

### Publish Subscribe Channel

Camel supports the Publish Subscribe Channel from the EIP patterns using the following components

- JMS for working with JMS Topics for high performance, clustering and load balancing
- XMPP when using rooms for group communication

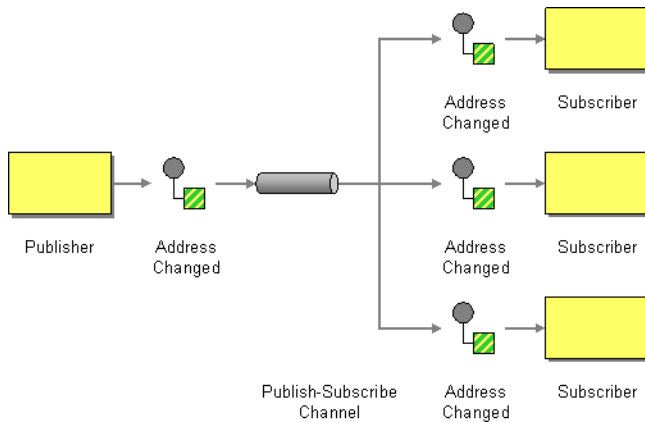

## Using Routing Logic

Another option is to explicitly list the publish-subscribe relationship in your routing logic; this keeps the producer and consumer decoupled but lets you control the fine grained routing configuration using the DSL or Xml Configuration.

### Using the Fluent Builders

```
RouteBuilder builder = new RouteBuilder() {
    public void configure() {
        from("seda:a").multicast().to("seda:b", "seda:c", "seda:d");
    }
};
```

### Using the Spring XML Extensions

```
<camelContext id="camel" xmlns="http://camel.apache.org/schema/spring">
  <route>
    <from uri="seda:a"/>
    <multicast>
      <to uri="seda:b"/>
      <to uri="seda:c"/>
      <to uri="seda:d"/>
    </multicast>
  </route>
</camelContext>
```

## Using This Pattern

If you would like to use this EIP Pattern then please read the Getting Started, you may also find the Architecture useful particularly the description of Endpoint and URIs. Then you could try out some of the Examples first before trying this pattern out.



## DEAD LETTER CHANNEL

Camel supports the Dead Letter Channel from the EIP patterns using the `DeadLetterChannel` processor which is an Error Handler.

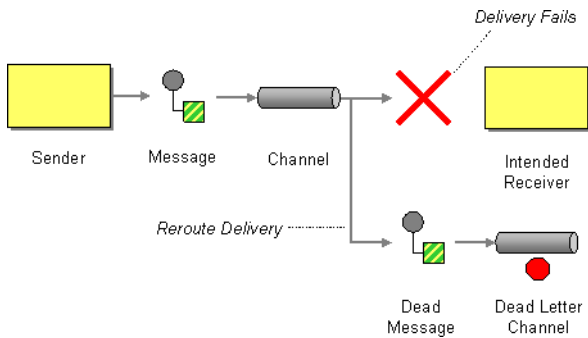

### Redelivery

It is common for a temporary outage or database deadlock to cause a message to fail to process; but the chances are if its tried a few more times with some time delay then it will complete fine. So we typically wish to use some kind of redelivery policy to decide how many times to try redeliver a message and how long to wait before redelivery attempts.

The `RedeliveryPolicy` defines how the message is to be redelivered. You can customize things like

- how many times a message is attempted to be redelivered before it is considered a failure and sent to the dead letter channel
- the initial redelivery timeout
- whether or not exponential backoff is used (i.e. the time between retries increases using a backoff multiplier)
- whether to use collision avoidance to add some randomness to the timings

Once all attempts at redelivering the message fails then the message is forwarded to the dead letter queue.

### OnRedelivery

#### Available in Camel 1.5.1 onwards

When Dead Letter Channel is doing redeliver its possible to configure a Processor that is executed just **before** every redelivery attempt. This can be used for the situations where you need to alter the message before its redelivered. See below for sample.

### Redelivery default values

The default redeliver policy will use the following values:

- `maximumRedeliveries=5`

- delay=1000L (1 second, **new as of Camel 2.0**)
  - use initialRedeliveryDelay for previous versions
- maximumRedeliveryDelay = 60 \* 1000L (60 seconds, **new option in Camel 1.4**)
- And the exponential backoff and collision avoidance is turned off.
- The retriesExhaustedLogLevel and retryAttemptedLogLevel are set to LoggingLevel.ERROR

The maximum redeliver delay ensures that a delay is never longer than the value, default 1 minute. This can happen if you turn on the exponential backoff.

The maximum redeliveries is the number of **re** delivery attempts. By default Camel will try to process the exchange 1 + 5 times. 1 time for the normal attempt and then 5 attempts as redeliveries.

Setting the maximumRedeliveries to a negative value such as -1 will then always redeliver (unlimited).

Setting the maximumRedeliveries to 0 will disable any re delivery attempt.

Camel will log delivery failures at the ERROR logging level by default. You can change this by specifying retriesExhaustedLogLevel and/or retryAttemptedLogLevel. See ExceptionBuilderWithRetryLoggingLevelSetTest for an example.

## Redelivery header

When a message is redelivered the DeadLetterChannel will append a customizable header to the message to indicate how many times its been redelivered. The default value is **org.apache.camel.redeliveryCount**.

The header **org.apache.camel.Redelivered** contains a boolean if the message is redelivered or not.

## Configuring via the DSL

The following example shows how to configure the Dead Letter Channel configuration using the DSL

```
RouteBuilder builder = new RouteBuilder() {
    public void configure() {
        // using dead letter channel with a seda queue for errors
        errorHandler(deadLetterChannel("seda:errors"));

        // here is our route
        from("seda:a").to("seda:b");
    }
};
```

You can also configure the RedeliveryPolicy as this example shows

```
RouteBuilder builder = new RouteBuilder() {
    public void configure() {
        // configures dead letter channel to use seda queue for errors and use at most
        2 redeliveries
    }
};
```

```

        // and exponential backoff

errorHandler(deadLetterChannel("seda:errors").maximumRedeliveries(2).useExponentialBackOff());

        // here is our route
        from("seda:a").to("seda:b");
    }
};

```

## How can I modify the Exchange before redelivery?

In Camel 1.5.1 we added support directly in Dead Letter Channel to set a Processor that is executed **before** each redelivery attempt. In older releases you have to sort to other solutions that isn't as solid as this new feature.

## Camel 1.5.0 or older

When Dead Letter Channel is doing redeliver it redeliveries immediately with the original Exchange that caused the error in the first place. However in some situations you might want to be able to alter the message before its redelivered. As Camel at this time of writing doesn't have a nice DSL syntax or configuration on the Dead Letter Channel to allow custom processing before redeliver we are gonna show a different solution, that actually also pin points the flexibility Camel has.

We are going to use an interceptor that gets triggered when an Exchange is being redelivered. We use the fact that interceptors by default will proceed from the point of interceptor. This is the Detour EIP pattern we are using.

The code below demonstrates this.

```

// we configure an interceptor that is triggered when the redelivery flag
// has been set TRUE on an exchange
intercept().when(header("org.apache.camel.Redelivered").isEqualTo(Boolean.TRUE)).
    process(new Processor() {
        public void process(Exchange exchange) throws Exception {
            // the message is being redelivered so we can alter it

            // we just append the redelivery counter to the body
            // you can of course do all kind of stuff instead
            String body = exchange.getIn().getBody(String.class);
            int count =
exchange.getIn().getHeader("org.apache.camel.RedeliveryCounter", Integer.class);

            exchange.getIn().setBody(body + count);
        }
    });

```

However you should notice as Camel will keep the redeliver flag on the Exchange for the remainder of its routing this interceptor will kick in for subsequence processing. So you should keep track if you already have altered the message before redelivery.

## Camel 1.5.1 or newer

When Dead Letter Channel is doing redeliver its possible to configure a Processor that is executed just **before** every redelivery attempt. This can be used for the situations where you need to alter the message before its redelivered.

Here we configure the Dead Letter Channel to use our processor `MyRedeliveryProcessor` to be executed before each redelivery.

```
// we configure our Dead Letter Channel to invoke
// MyRedeliveryProcessor before a redelivery is
// attempted. This allows us to alter the message before
errorHandler(deadLetterChannel("mock:error")
    .onRedelivery(new MyRedeliverProcessor())
    // setting delay to zero is just to make unit teting faster
    .delay(0L));
```

And this is the processor `MyRedeliveryProcessor` where we alter the message.

```
// This is our processor that is executed before every redelivery attempt
// here we can do what we want in the java code, such as altering the message
public class MyRedeliverPrcessor implements Processor {

    public void process(Exchange exchange) throws Exception {
        // the message is being redelivered so we can alter it

        // we just append the redelivery counter to the body
        // you can of course do all kind of stuff instead
        String body = exchange.getIn().getBody(String.class);
        int count = exchange.getIn().getHeader("org.apache.camel.RedeliveryCounter",
Integer.class);

        exchange.getIn().setBody(body + count);
    }
}
```

## Using This Pattern

If you would like to use this EIP Pattern then please read the Getting Started, you may also find the Architecture useful particularly the description of Endpoint and URIs. Then you could try out some of the Examples first before trying this pattern out.

- Error Handler
- Exception Clause

## Guaranteed Delivery

Camel supports the Guaranteed Delivery from the EIP patterns using the following components

- File for using file systems as a persistent store of messages
- JMS when using persistent delivery (the default) for working with JMS Queues and Topics for high performance, clustering and load balancing

- JPA for using a database as a persistence layer

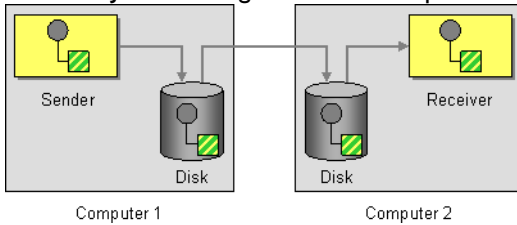

## Using This Pattern

If you would like to use this EIP Pattern then please read the Getting Started, you may also find the Architecture useful particularly the description of Endpoint and URIs. Then you could try out some of the Examples first before trying this pattern out.

## Message Bus

Camel supports the Message Bus from the EIP patterns. You could view Camel as a Message Bus itself as it allows producers and consumers to be decoupled.

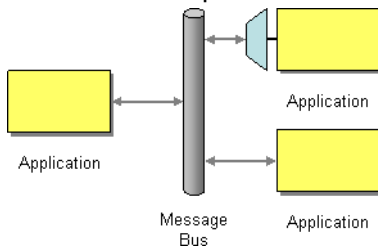

Folks often assume that a Message Bus is a JMS though so you may wish to refer to the JMS component for traditional MOM support.

Also worthy of note is the XMPP component for supporting messaging over XMPP (Jabber)

## Using This Pattern

If you would like to use this EIP Pattern then please read the Getting Started, you may also find the Architecture useful particularly the description of Endpoint and URIs. Then you could try out some of the Examples first before trying this pattern out.

# MESSAGE ROUTING

## Content Based Router

The Content Based Router from the EIP patterns allows you to route messages to the correct destination based on the contents of the message exchanges.

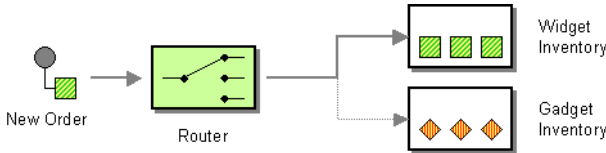

The following example shows how to route a request from an input **seda:a** endpoint to either **seda:b**, **seda:c** or **seda:d** depending on the evaluation of various Predicate expressions

### Using the Fluent Builders

```
RouteBuilder builder = new RouteBuilder() {  
    public void configure() {  
        from("seda:a").choice().when(header("foo").isEqualTo("bar")).to("seda:b")  
  
        .when(header("foo").isEqualTo("cheese")).to("seda:c").otherwise().to("seda:d");  
    }  
};
```

### Using the Spring XML Extensions

```
<camelContext id="camel" xmlns="http://camel.apache.org/schema/spring">  
    <route>  
        <from uri="seda:a"/>  
        <choice>  
            <when>  
                <xpath>$foo = 'bar'</xpath>  
                <to uri="seda:b"/>  
            </when>  
            <when>  
                <xpath>$foo = 'cheese'</xpath>  
                <to uri="seda:c"/>  
            </when>  
            <otherwise>  
                <to uri="seda:d"/>  
            </otherwise>  
        </choice>  
    </route>  
</camelContext>
```

For further examples of this pattern in use you could look at the junit test case

## Using This Pattern

If you would like to use this EIP Pattern then please read the Getting Started, you may also find the Architecture useful particularly the description of Endpoint and URIs. Then you could try out some of the Examples first before trying this pattern out.

### Message Filter

The Message Filter from the EIP patterns allows you to filter messages

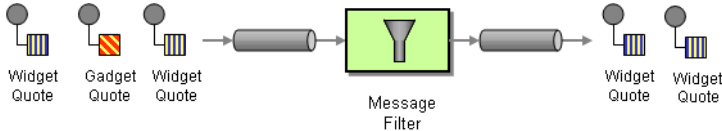

The following example shows how to create a Message Filter route consuming messages from an endpoint called **queue:a** which if the Predicate is true will be dispatched to **queue:b**

#### Using the Fluent Builders

```
RouteBuilder builder = new RouteBuilder() {
    public void configure() {
        from("seda:a").filter(header("foo").isEqualTo("bar")).to("seda:b");
    }
};
```

You can of course use many different Predicate languages such as XPath, XQuery, SQL or various Scripting Languages. Here is an XPath example

```
from("direct:start").
    filter().xpath("/person[@name='James']").
    to("mock:result");
```

#### Using the Spring XML Extensions

```
<camelContext id="camel" xmlns="http://camel.apache.org/schema/spring">
  <route>
    <from uri="seda:a"/>
    <filter>
      <xpath>$foo = 'bar'</xpath>
      <to uri="seda:b"/>
    </filter>
  </route>
</camelContext>
```

For further examples of this pattern in use you could look at the junit test case

## Using This Pattern

If you would like to use this EIP Pattern then please read the Getting Started, you may also find the Architecture useful particularly the description of Endpoint and URIs. Then you could try out some of the Examples first before trying this pattern out.

## Recipient List

The Recipient List from the EIP patterns allows you to route messages to a number of dynamically specified recipients.

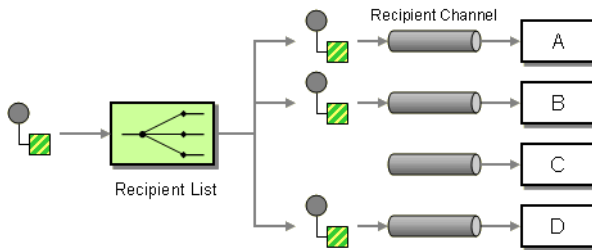

## Static Recipient List

The following example shows how to route a request from an input **queue:a** endpoint to a static list of destinations

### Using Annotations

You can use the `RecipientList` Annotation on a POJO to create a Dynamic Recipient List. For more details see the [Bean Integration](#).

### Using the Fluent Builders

```
RouteBuilder builder = new RouteBuilder() {  
    public void configure() {  
        from("seda:a").multicast().to("seda:b", "seda:c", "seda:d");  
    }  
};
```

### Using the Spring XML Extensions

```
<camelContext id="camel" xmlns="http://camel.apache.org/schema/spring">  
    <route>  
        <from uri="seda:a"/>  
        <multicast>  
            <to uri="seda:b"/>  
            <to uri="seda:c"/>  
            <to uri="seda:d"/>  
        </multicast>  
    </route>  
</camelContext>
```

## Dynamic Recipient List

Usually one of the main reasons for using the Recipient List pattern is that the list of recipients is dynamic and calculated at runtime. The following example demonstrates how to create a dynamic recipient list using an Expression (which in this case it extracts a named header value



dynamically) to calculate the list of endpoints which are either of type Endpoint or are converted to a String and then resolved using the endpoint URIs.

### Using the Fluent Builders

```
RouteBuilder builder = new RouteBuilder() {
    public void configure() {
        from("seda:a").recipientList(header("foo"));
    }
};
```

The above assumes that the header contains a list of endpoint URIs. The following takes a single string header and tokenizes it

```
from("direct:a").recipientList(
    header("recipientListHeader").tokenize(", "));
```

### Iterable value

The dynamic list of recipients that are defined in the header must be iterable such as:

- java.util.Collection
- java.util.Iterator
- arrays
- org.w3c.dom.NodeList
- **Camel 1.5.1:** a single String with values separated with comma
- any other type will be regarded as a single value

### Using the Spring XML Extensions

```
<camelContext id="camel" xmlns="http://camel.apache.org/schema/spring">
  <route>
    <from uri="seda:a"/>
    <recipientList>
      <xpath>$foo</xpath>
    </recipientList>
  </route>
</camelContext>
```

For further examples of this pattern in use you could look at one of the junit test case

### Using delimiter in Spring XML

#### Available as of Camel 1.5.1

In Spring DSL you can set the `delimiter` attribute for setting a delimiter to be used if the header value is a single String with multiple separated endpoints.

```
<route>
  <from uri="direct:a" />
  <!-- use comma as a delimiter for String based values -->
  <recipientList delimiter=",">
    <header>myHeader</header>
```

```
</recipientList>
</route>
```

So if **myHeader** contains a String with the value "activemq:queue:foo, activemq:topic:hello , log:bar" then Camel will split the String using the delimiter given in the XML that was comma, resulting into 3 endpoints to send to. You can use spaces between the endpoints as Camel will trim the value when it lookup the endpoint to send to.

Note: In Java DSL you use the `tokenizer` to archive the same. The route above in Java DSL:

```
from("direct:a").recipientList(header("myHeader").tokenizer(", "));
```

## Using This Pattern

If you would like to use this EIP Pattern then please read the Getting Started, you may also find the Architecture useful particularly the description of Endpoint and URIs. Then you could try out some of the Examples first before trying this pattern out.

### Splitter

The Splitter from the EIP patterns allows you split a message into a number of pieces and process them individually

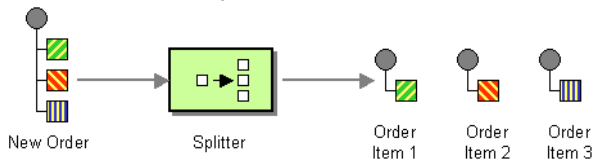

As of Camel 2.0, you need to specify a Splitter as `split()`. In earlier versions of Camel, you need to use `splitter()`.

## Example

The following example shows how to take a request from the **queue:a** endpoint the split it into pieces using an Expression, then forward each piece to **queue:b**

### Using the Fluent Builders

```
RouteBuilder builder = new RouteBuilder() {
    public void configure() {
        from("seda:a").split(body(String.class).tokenize("\n")).to("seda:b");
    }
};
```

The splitter can use any Expression language so you could use any of the Languages Supported such as XPath, XQuery, SQL or one of the Scripting Languages to perform the split. e.g.

```
from("activemq:my.queue").split(xpath("//foo/  
bar")).convertBodyTo(String.class).to("file://some/directory")
```

## Using the Spring XML Extensions

```
<camelContext id="camel" xmlns="http://camel.apache.org/schema/spring">  
  <route>  
    <from uri="seda:a"/>  
    <split>  
      <xpath>/invoice/lineItems</xpath>  
      <to uri="seda:b"/>  
    </split>  
  </route>  
</camelContext>
```

For further examples of this pattern in use you could look at one of the junit test case

## Message Headers

The following headers is set on each Exchange that are split:

header	type	description
org.apache.camel.splitCounter	int	A split counter that increases for each Exchange being split. The counter starts from 0.
org.apache.camel.splitSize	int	The total number of Exchanges that was splitted. This header is not applied for stream based

## Parallel execution of distinct 'parts'

If you want to execute all parts in parallel you can use special notation of `split()` with two arguments, where the second one is a **boolean** flag if processing should be parallel. e.g.

```
XPathBuilder xPathBuilder = new XPathBuilder("//foo/bar");  
from("activemq:my.queue").split(xPathBuilder, true).to("activemq:my.parts");
```

In **Camel 2.0** the boolean option has been refactored into a builder method `parallelProcessing` so its easier to understand what the route does when we use a method instead of `true|false`.

```
XPathBuilder xPathBuilder = new XPathBuilder("//foo/bar");  
from("activemq:my.queue").split(xPathBuilder).parallelProcessing().to("activemq:my.parts");
```

## Stream based

### Available as of Camel 1.5

You can split streams by enabling the streaming mode using the `streaming` builder method.

```
from("direct:streaming").split(body().tokenize(",")).streaming().to("activemq:my.parts");
```

## Specifying a custom aggregation strategy

### Available as of Camel 2.0

This is specified similar to the `Aggregator`.

## Specifying a custom `ThreadPoolExecutor`

You can customize the underlying `ThreadPoolExecutor` used in the parallel splitter. In the Java DSL try something like this:

```
XPathBuilder xPathBuilder = new XPathBuilder("//foo/bar");
ThreadPoolExecutor threadPoolExecutor = new ThreadPoolExecutor(8, 16, 0L,
    TimeUnit.MILLISECONDS, new LinkedBlockingQueue());
from("activemq:my.queue").split(xPathBuilder, true,
    threadPoolExecutor).to("activemq:my.parts");
```

In the Spring DSL try this:

### Available as of Camel 1.5.1

```
<camelContext id="camel" xmlns="http://camel.apache.org/schema/spring">
  <route>
    <from uri="direct:parallel-custom-pool"/>
    <split threadPoolExecutorRef="threadPoolExecutor">
      <xpath>/invoice/lineItems</xpath>
      <to uri="mock:result"/>
    </split>
  </route>
</camelContext>

<!-- There's an easier way of specifying constructor args, just can't remember it
    at the moment... old Spring syntax will do for now! -->
<bean id="threadPoolExecutor" class="java.util.concurrent.ThreadPoolExecutor">
  <constructor-arg index="0"><value>8</value></constructor-arg>
  <constructor-arg index="1"><value>16</value></constructor-arg>
  <constructor-arg index="2"><value>0</value></constructor-arg>
  <constructor-arg index="3"><value>MILLISECONDS</value></constructor-arg>
  <constructor-arg index="4"><bean
    class="java.util.concurrent.LinkedBlockingQueue"/></constructor-arg>
</bean>
```

## Using This Pattern

If you would like to use this EIP Pattern then please read the Getting Started, you may also find the Architecture useful particularly the description of Endpoint and URIs. Then you could try out some of the Examples first before trying this pattern out.

### Resequencer

The Resequencer from the EIP patterns allows you to reorganise messages based on some comparator. By default in Camel we use an Expression to create the comparator; so that you can compare by a message header or the body or a piece of a message etc.

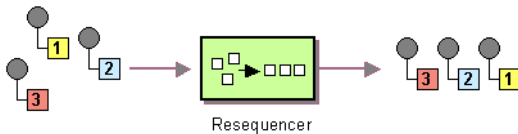

Camel supports two resequencing algorithms:

- **Batch resequencing** collects messages into a batch, sorts the messages and sends them to their output.
- **Stream resequencing** re-orders (continuous) message streams based on the detection of gaps between messages.

### Batch Resequencing

The following example shows how to use the batch-processing resequencer so that messages are sorted in order of the **body()** expression. That is messages are collected into a batch (either by a maximum number of messages per batch or using a timeout) then they are sorted in order and then sent out to their output.

#### Using the Fluent Builders

```
from("direct:start").resequencer(body()).to("mock:result");
```

This is equivalent to

```
from("direct:start").resequencer(body()).batch().to("mock:result");
```

The batch-processing resequencer can be further configured via the `size()` and `timeout()` methods.

```
from("direct:start").resequencer(body()).batch().size(300).timeout(4000L).to("mock:result")
```

This sets the batch size to 300 and the batch timeout to 4000 ms (by default, the batch size is 100 and the timeout is 1000 ms). Alternatively, you can provide a configuration object.

```
from("direct:start").resequencer(body()).batch(new BatchResequencerConfig(300, 4000L)).to("mock:result")
```

So the above example will reorder messages from endpoint **direct:a** in order of their bodies, to the endpoint **mock:result**. Typically you'd use a header rather than the body to order things; or maybe a part of the body. So you could replace this expression with

```
resequencer(header("JMSPriority"))
```

for example to reorder messages using their JMS priority.

You can of course use many different Expression languages such as XPath, XQuery, SQL or various Scripting Languages.

You can also use multiple expressions; so you could for example sort by priority first then some other custom header

```
resequencer(header("JMSPriority"), header("MyCustomerRating"))
```

## Using the Spring XML Extensions

```
<camelContext id="camel" xmlns="http://camel.apache.org/schema/spring">
  <route>
    <from uri="direct:start" />
    <resequencer>
      <simple>body</simple>
      <to uri="mock:result" />
      <!--
        batch-config can be omitted for default (batch) resequencer settings
      -->
      <batch-config batchSize="300" batchTimeout="4000" />
    </resequencer>
  </route>
</camelContext>
```

## Stream Resequencing

The next example shows how to use the stream-processing resequencer. Messages are re-ordered based on their sequence numbers given by a `seqnum` header using gap detection and timeouts on the level of individual messages.

### Using the Fluent Builders

```
from("direct:start").resequencer(header("seqnum")).stream().to("mock:result");
```

The stream-processing resequencer can be further configured via the `capacity()` and `timeout()` methods.

```
from("direct:start").resequencer(header("seqnum")).stream().capacity(5000).timeout(4000L).to("mock:result");
```

This sets the resequencer's capacity to 5000 and the timeout to 4000 ms (by default, the capacity is 100 and the timeout is 1000 ms). Alternatively, you can provide a configuration object.

```
from("direct:start").resequencer(header("seqnum")).stream(new
StreamResequencerConfig(5000, 4000L)).to("mock:result")
```

The stream-processing resequencer algorithm is based on the detection of gaps in a message stream rather than on a fixed batch size. Gap detection in combination with timeouts removes the constraint of having to know the number of messages of a sequence (i.e. the batch size) in advance. Messages must contain a unique sequence number for which a predecessor and a successor is known. For example a message with the sequence number 3 has a predecessor message with the sequence number 2 and a successor message with the sequence number 4. The message sequence 2,3,5 has a gap because the successor of 3 is missing. The resequencer therefore has to retain message 5 until message 4 arrives (or a timeout occurs).

If the maximum time difference between messages (with successor/predecessor relationship with respect to the sequence number) in a message stream is known, then the resequencer's timeout parameter should be set to this value. In this case it is guaranteed that all messages of a stream are delivered in correct order to the next processor. The lower the timeout value is compared to the out-of-sequence time difference the higher is the probability for out-of-sequence messages delivered by this resequencer. Large timeout values should be supported by sufficiently high capacity values. The capacity parameter is used to prevent the resequencer from running out of memory.

By default, the stream resequencer expects long sequence numbers but other sequence numbers types can be supported as well by providing a custom comparator via the `comparator()` method

```
ExpressionResultComparator<Exchange> comparator = new MyComparator();
from("direct:start").resequencer(header("seqnum")).stream().comparator(comparator).to("mock:result");
```

or via a `StreamResequencerConfig` object.

```
ExpressionResultComparator<Exchange> comparator = new MyComparator();
StreamResequencerConfig config = new StreamResequencerConfig(100, 1000L, comparator);
from("direct:start").resequencer(header("seqnum")).stream(config).to("mock:result");
```

## Using the Spring XML Extensions

```
<camelContext id="camel" xmlns="http://camel.apache.org/schema/spring">
  <route>
    <from uri="direct:start"/>
    <resequencer>
      <simple>in.header.seqnum</simple>
      <to uri="mock:result" />
      <stream-config capacity="5000" timeout="4000"/>
    </resequencer>
  </route>
</camelContext>
```

## Further Examples

For further examples of this pattern in use you could look at the batch-processing resequencer junit test case and the stream-processing resequencer junit test case

## Using This Pattern

If you would like to use this EIP Pattern then please read the Getting Started, you may also find the Architecture useful particularly the description of Endpoint and URIs. Then you could try out some of the Examples first before trying this pattern out.

## MESSAGE TRANSFORMATION

### Content Enricher

Camel supports the Content Enricher from the EIP patterns using a Message Translator or by using an arbitrary Processor in the routing logic to enrich the message.

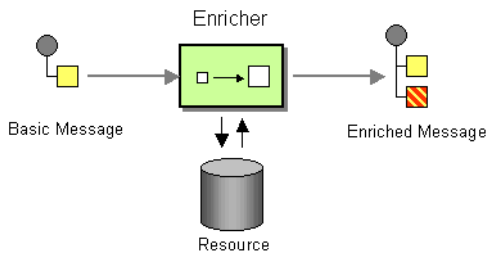

### Using the Fluent Builders

You can use Templating to consume a message from one destination, transform it with something like Velocity or XQuery and then send it on to another destination. For example using InOnly (one way messaging)

```
from("activemq:My.Queue").
  to("velocity:com/acme/MyResponse.vm").
  to("activemq:Another.Queue");
```

If you want to use InOut (request-reply) semantics to process requests on the **My.Queue** queue on ActiveMQ with a template generated response, then sending responses back to the JMSReplyTo Destination you could use this.

```
from("activemq:My.Queue").
  to("velocity:com/acme/MyResponse.vm");
```

Here is a simple example using the DSL directly to transform the message body

```
from("direct:start").setBody(body().append(" World!")).to("mock:result");
```

In this example we add our own Processor using explicit Java code

```
from("direct:start").process(new Processor() {
  public void process(Exchange exchange) {
    Message in = exchange.getIn();
    in.setBody(in.getBody(String.class) + " World!");
  }
}).to("mock:result");
```



Finally we can use Bean Integration to use any Java method on any bean to act as the transformer

```
from("activemq:My.Queue").
  beanRef("myBeanName", "myMethodName").
  to("activemq:Another.Queue");
```

For further examples of this pattern in use you could look at one of the JUnit tests

- TransformTest
- TransformViaDSLTest

## Using Spring XML

```
<route>
  <from uri="activemq:Input"/>
  <bean ref="myBeanName" method="doTransform"/>
  <to uri="activemq:Output"/>
</route>
```

## Using This Pattern

If you would like to use this EIP Pattern then please read the Getting Started, you may also find the Architecture useful particularly the description of Endpoint and URIs. Then you could try out some of the Examples first before trying this pattern out.

## Content Filter

Camel supports the Content Filter from the EIP patterns using one of the following mechanisms in the routing logic to transform content from the inbound message.

- Message Translator
- invoking a Java bean
- Processor object

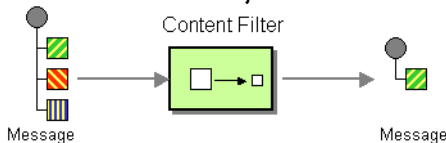

A common way to filter messages is to use an Expression in the DSL like XQuery, SQL or one of the supported Scripting Languages.

### Using the Fluent Builders

Here is a simple example using the DSL directly

```
from("direct:start").setBody(body().append(" World!")).to("mock:result");
```

In this example we add our own Processor

```
from("direct:start").process(new Processor() {
  public void process(Exchange exchange) {
    Message in = exchange.getIn();
```

```

        in.setBody(in.getBody(String.class) + " World!");
    }
}).to("mock:result");

```

For further examples of this pattern in use you could look at one of the JUnit tests

- TransformTest
- TransformViaDSLTest

## Using Spring XML

```

<route>
  <from uri="activemq:Input"/>
  <bean ref="myBeanName" method="doTransform"/>
  <to uri="activemq:Output"/>
</route>

```

## Using This Pattern

If you would like to use this EIP Pattern then please read the Getting Started, you may also find the Architecture useful particularly the description of Endpoint and URIs. Then you could try out some of the Examples first before trying this pattern out.

## Normalizer

Camel supports the Normalizer from the EIP patterns by using a Message Router in front of a number of Message Translator instances.

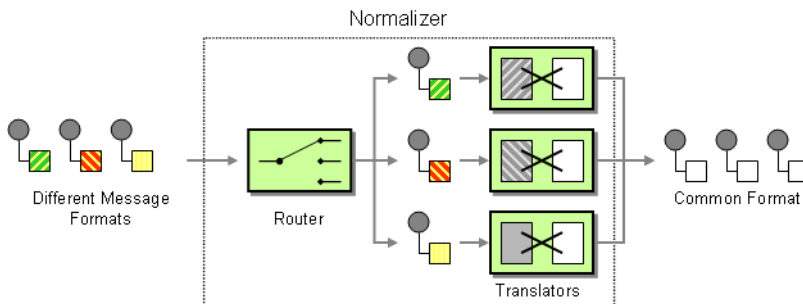

## Example

This example shows a Message Normalizer that converts two types of XML messages into a common format. Messages in this common format are then filtered.

### Using the Fluent Builders

```

// we need to normalize two types of incoming messages
from("direct:start").choice()
    .when().xpath("/employee").to("bean:normalizer?method=employeeToPerson").to("mock:result")

```

```
.when().xpath("/customer").to("bean:normalizer?method=customerToPerson").to("mock:result");
```

In this case we're using a Java bean as the normalizer. The class looks like this

```
public class MyNormalizer {
    public void employeeToPerson(Exchange exchange, @XPath("/employee/name/text()")
String name) {
        exchange.getOut().setBody(createPerson(name));
    }

    public void customerToPerson(Exchange exchange, @XPath("/customer/@name") String
name) {
        exchange.getOut().setBody(createPerson(name));
    }

    private String createPerson(String name) {
        return "<person name=\"" + name + "\"/>";
    }
}
```

## Using the Spring XML Extensions

The same example in the Spring DSL

```
<camelContext id="camel" xmlns="http://camel.apache.org/schema/spring">
  <route>
    <from uri="direct:start"/>
    <choice>
      <when>
        <xpath>/employee</xpath>
        <to uri="bean:normalizer?method=employeeToPerson"/>
        <to uri="mock:result"/>
      </when>
      <when>
        <xpath>/customer</xpath>
        <to uri="bean:normalizer?method=customerToPerson"/>
        <to uri="mock:result"/>
      </when>
    </choice>
  </route>
</camelContext>

<bean id="normalizer" class="org.apache.camel.processor.MyNormalizer"/>
```

## See Also

- Message Router
- Content Based Router
- Message Translator

## Using This Pattern

If you would like to use this EIP Pattern then please read the Getting Started, you may also find the Architecture useful particularly the description of Endpoint and URIs. Then you could try out some of the Examples first before trying this pattern out.

## MESSAGING ENDPOINTS

### Messaging Mapper

Camel supports the Messaging Mapper from the EIP patterns by using either Message Translator pattern or the Type Converter module.

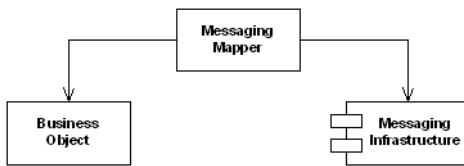

### See also

- Message Translator
- Type Converter
- CXF for JAX-WS support for binding business logic to messaging & web services
- POJO
- Bean

## Using This Pattern

If you would like to use this EIP Pattern then please read the Getting Started, you may also find the Architecture useful particularly the description of Endpoint and URIs. Then you could try out some of the Examples first before trying this pattern out.

### Event Driven Consumer

Camel supports the Event Driven Consumer from the EIP patterns. The default consumer model is event based (i.e. asynchronous) as this means that the Camel container can then manage pooling, threading and concurrency for you in a declarative manner.

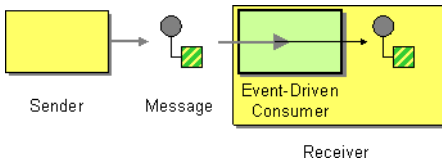

The Event Driven Consumer is implemented by consumers implementing the Processor interface which is invoked by the Message Endpoint when a Message is available for processing.

For more details see

- Message
- Message Endpoint

## Using This Pattern

If you would like to use this EIP Pattern then please read the Getting Started, you may also find the Architecture useful particularly the description of Endpoint and URIs. Then you could try out some of the Examples first before trying this pattern out.

## Polling Consumer

Camel supports implementing the Polling Consumer from the EIP patterns using the PollingConsumer interface which can be created via the Endpoint.createPollingConsumer() method.

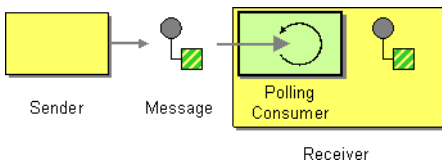

So in your Java code you can do

```
Endpoint endpoint = context.getEndpoint("activemq:my.queue");
PollingConsumer consumer = endpoint.createPollingConsumer();
Exchange exchange = consumer.receive();
```

There are 3 main polling methods on PollingConsumer

Method name	Description
receive()	Waits until a message is available and then returns it; potentially blocking forever
receive(long)	Attempts to receive a message exchange, waiting up to the given timeout and returning null if no message exchange could be received within the time available

`receiveNoWait()` Attempts to receive a message exchange immediately without waiting and returning null if a message exchange is not available yet

---

## Scheduled Poll Components

Quite a few inbound Camel endpoints use a scheduled poll pattern to receive messages and push them through the Camel processing routes. That is to say externally from the client the endpoint appears to use an Event Driven Consumer but internally a scheduled poll is used to monitor some kind of state or resource and then fire message exchanges.

Since this is such a common pattern, polling components can extend the `ScheduledPollConsumer` base class which makes it simpler to implement this pattern.

There is also the Quartz Component which provides scheduled delivery of messages using the Quartz enterprise scheduler.

For more details see

- `PollingConsumer`
- Scheduled Polling Components
  - `ScheduledPollConsumer`
  - File
  - JPA
  - Mail
  - Quartz

## Using This Pattern

If you would like to use this EIP Pattern then please read the [Getting Started](#), you may also find the [Architecture](#) useful particularly the description of Endpoint and URIs. Then you could try out some of the [Examples](#) first before trying this pattern out.

## Competing Consumers

Camel supports the Competing Consumers from the EIP patterns using a few different components.

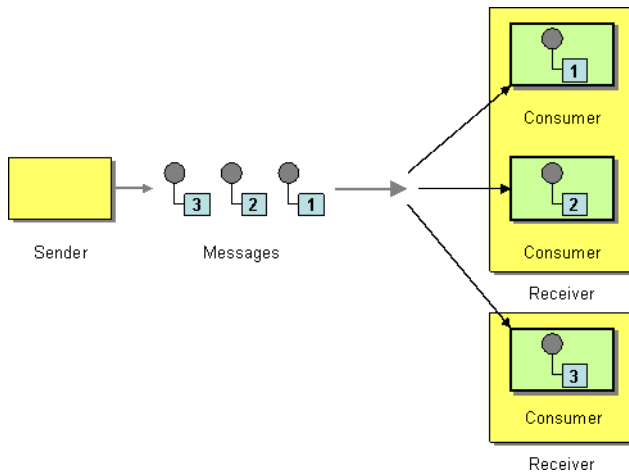

You can use the following components to implement competing consumers:-

- Seda for SEDA based concurrent processing using a thread pool
- JMS for distributed SEDA based concurrent processing with queues which support reliable load balancing, failover and clustering.

### Enabling Competing Consumers with JMS

To enable Competing Consumers you just need to set the **concurrentConsumers** property on the JMS endpoint.

For example

```
from("jms:MyQueue?concurrentConsumers=5").bean(SomeBean.class);
```

Or just run multiple JVMs of any ActiveMQ or JMS route 😊

### Using This Pattern

If you would like to use this EIP Pattern then please read the Getting Started, you may also find the Architecture useful particularly the description of Endpoint and URIs. Then you could try out some of the Examples first before trying this pattern out.

### Message Dispatcher

Camel supports the Message Dispatcher from the EIP patterns using various approaches.

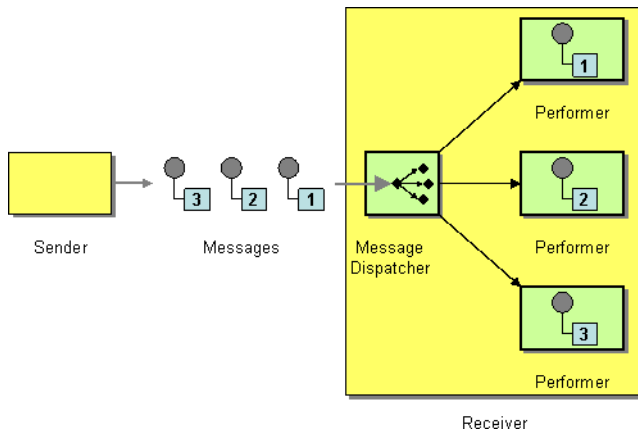

You can use a component like JMS with selectors to implement a Selective Consumer as the Message Dispatcher implementation. Or you can use an Endpoint as the Message Dispatcher itself and then use a Content Based Router as the Message Dispatcher.

## See Also

- JMS
- Selective Consumer
- Content Based Router
- Endpoint

## Using This Pattern

If you would like to use this EIP Pattern then please read the Getting Started, you may also find the Architecture useful particularly the description of Endpoint and URIs. Then you could try out some of the Examples first before trying this pattern out.

### Selective Consumer

The Selective Consumer from the EIP patterns can be implemented in two ways

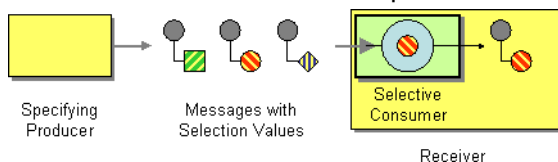

The first solution is to provide a Message Selector to the underlying URIs when creating your consumer. For example when using JMS you can specify a selector parameter so that the message broker will only deliver messages matching your criteria.



The other approach is to use a Message Filter which is applied; then if the filter matches the message your consumer is invoked as shown in the following example

### Using the Fluent Builders

```
RouteBuilder builder = new RouteBuilder() {
    public void configure() {
        from("seda:a").filter(header("foo").isEqualTo("bar")).process(myProcessor);
    }
};
```

### Using the Spring XML Extensions

```
<bean id="myProcessor" class="org.apache.camel.builder.MyProcessor"/>

<camelContext id="camel" xmlns="http://camel.apache.org/schema/spring">
  <route>
    <from uri="seda:a"/>
    <filter>
      <xpath>$foo = 'bar'</xpath>
      <process ref="myProcessor"/>
    </filter>
  </route>
</camelContext>
```

## Using This Pattern

If you would like to use this EIP Pattern then please read the Getting Started, you may also find the Architecture useful particularly the description of Endpoint and URIs. Then you could try out some of the Examples first before trying this pattern out.

### Durable Subscriber

Camel supports the Durable Subscriber from the EIP patterns using the JMS component which supports publish & subscribe using Topics with support for non-durable and durable subscribers.

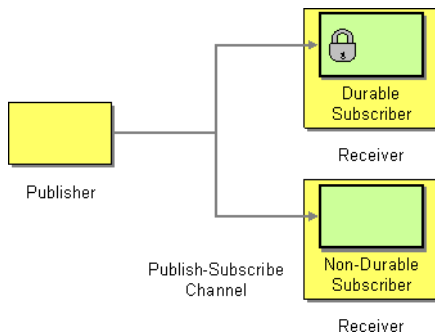

Another alternative is to combine the Message Dispatcher or Content Based Router with File or JPA components for durable subscribers then something like Queue for non-durable.

## See Also

- JMS
- File
- JPA
- Message Dispatcher
- Selective Consumer
- Content Based Router
- Endpoint

## Using This Pattern

If you would like to use this EIP Pattern then please read the Getting Started, you may also find the Architecture useful particularly the description of Endpoint and URIs. Then you could try out some of the Examples first before trying this pattern out.

### Idempotent Consumer

The Idempotent Consumer from the EIP patterns is used to filter out duplicate messages.

This pattern is implemented using the `IdempotentConsumer` class. This uses an Expression to calculate a unique message ID string for a given message exchange; this ID can then be looked up in the `MessageIdRepository` to see if it has been seen before; if it has the message is consumed; if its not then the message is processed and the ID is added to the repository.

The Idempotent Consumer essentially acts like a Message Filter to filter out duplicates.

#### Using the Fluent Builders

The following example will use the header **myMessageId** to filter out duplicates

```
RouteBuilder builder = new RouteBuilder() {
    public void configure() {
        from("seda:a").idempotentConsumer(header("myMessageId"),
            MemoryIdempotentRepository.memoryIdempotentRepository(200))
            .to("seda:b");
    }
};
```

The above example will use an in-memory based `MessageIdRepository` which can easily run out of memory and doesn't work in a clustered environment. So you might prefer to use the JPA based implementation which uses a database to store the message IDs which have been processed

```
return new SpringRouteBuilder() {
    public void configure() {
        from("direct:start").idempotentConsumer(
            header("messageId"),
            jpaMessageIdRepository(bean(JpaTemplate.class), PROCESSOR_NAME)
        ).to("mock:result");
    }
};
```

```
}  
};
```

In the above example we are using the header **messageId** to filter out duplicates and using the collection **myProcessorName** to indicate the Message ID Repository to use. This name is important as you could process the same message by many different processors; so each may require its own logical Message ID Repository.

### Using the Spring XML Extensions

```
<bean id="myProcessor" class="org.apache.camel.builder.MyProcessor"/>  
  
<camelContext id="camel" xmlns="http://camel.apache.org/schema/spring">  
  <route>  
    <from uri="seda:a"/>  
    <filter>  
      <xpath>$foo = 'bar'</xpath>  
      <process ref="myProcessor"/>  
    </filter>  
  </route>  
</camelContext>
```

For further examples of this pattern in use you could look at the junit test case

## Using This Pattern

If you would like to use this EIP Pattern then please read the Getting Started, you may also find the Architecture useful particularly the description of Endpoint and URIs. Then you could try out some of the Examples first before trying this pattern out.

### Transactional Client

Camel recommends supporting the Transactional Client from the EIP patterns using spring transactions.

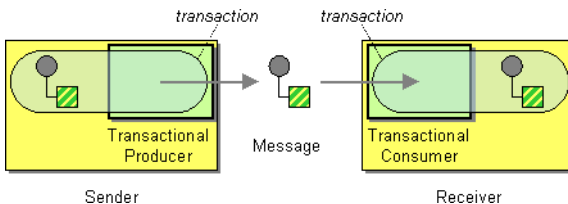

Transaction Oriented Endpoints (Camel Toes) like JMS support using a transaction for both inbound and outbound message exchanges. Endpoints that support transactions will participate in the current transaction context that they are called from.

You should use the SpringRouteBuilder to setup the routes since you will need to setup the spring context with the TransactionTemplates that will define the transaction manager configuration and policies.



## Configuration of Redelivery

The redelivery in transacted mode is **not** handled by Camel but by the backing system (the transaction manager). In such cases you should resort to the backing system how to configure the redelivery. Camel only supports setting a fixed delay between each redelivery attempt. This is configured by setting a `DelayPolicy` with the fixed value.

For inbound endpoint to be transacted, they normally need to be configured to use a Spring `PlatformTransactionManager`. In the case of the JMS component, this can be done by looking it up in the spring context.

You first define needed object in the spring configuration.

```
<bean id="jmsTransactionManager"
class="org.springframework.jms.connection.JmsTransactionManager">
  <property name="connectionFactory" ref="jmsConnectionFactory" />
</bean>

<bean id="jmsConnectionFactory"
class="org.apache.activemq.ActiveMQConnectionFactory">
  <property name="brokerURL" value="tcp://localhost:61616"/>
</bean>
```

Then you look them up and use them to create the `JmsComponent`.

```
PlatformTransactionManager transactionManager = (PlatformTransactionManager)
spring.getBean("jmsTransactionManager");
ConnectionFactory connectionFactory = (ConnectionFactory)
spring.getBean("jmsConnectionFactory");
JmsComponent component = JmsComponent.jmsComponentTransacted(connectionFactory,
transactionManager);
component.getConfiguration().setConcurrentConsumers(1);
ctx.addComponent("activemq", component);
```

## Transaction Policies

Outbound endpoints will automatically enlist in the current transaction context. But what if you do not want your outbound endpoint to enlist in the same transaction as your inbound endpoint? The solution is to add a Transaction Policy to the processing route. You first have to define transaction policies that you will be using. The policies use a spring `TransactionTemplate` to declare the transaction demarcation use. So you will need to add something like the following to your spring xml:

```
<bean id="PROPAGATION_REQUIRED"
class="org.springframework.transaction.support.TransactionTemplate">
  <property name="transactionManager" ref="jmsTransactionManager"/>
</bean>

<bean id="PROPAGATION_NOT_SUPPORTED"
```

```

class="org.springframework.transaction.support.TransactionTemplate">
  <property name="transactionManager" ref="jmsTransactionManager"/>
  <property name="propagationBehaviorName" value="PROPAGATION_NOT_SUPPORTED"/>
</bean>

<bean id="PROPAGATION_REQUIRES_NEW"
class="org.springframework.transaction.support.TransactionTemplate">
  <property name="transactionManager" ref="jmsTransactionManager"/>
  <property name="propagationBehaviorName" value="PROPAGATION_REQUIRES_NEW"/>
</bean>

```

Then in your `SpringRouteBuilder`, you just need to create new `SpringTransactionPolicy` objects for each of the templates.

```

public void configure() {
    ...
    Policy required = new SpringTransactionPolicy(bean(TransactionTemplate.class,
"PROPAGATION_REQUIRED"));
    Policy notsupported = new SpringTransactionPolicy(bean(TransactionTemplate.class,
"PROPAGATION_NOT_SUPPORTED"));
    Policy requirenew = new SpringTransactionPolicy(bean(TransactionTemplate.class,
"PROPAGATION_REQUIRES_NEW"));
    ...
}

```

Once created, you can use the Policy objects in your processing routes:

```

// Send to bar in a new transaction
from("activemq:queue:foo").policy(requirenew).to("activemq:queue:bar");

// Send to bar without a transaction.
from("activemq:queue:foo").policy(notsupported).to("activemq:queue:bar");

```

## Transaction Policies improvements in Camel 1.4

In Camel 1.4 we have eased the syntax to setup the transaction policies directly on the `SpringTransactionPolicy` object:

```

<bean id="PROPAGATION_REQUIRED"
class="org.apache.camel.spring.spi.SpringTransactionPolicy">
  <property name="transactionManager" ref="jmsTransactionManager"/>
</bean>

<bean id="PROPAGATION_REQUIRES_NEW"
class="org.apache.camel.spring.spi.SpringTransactionPolicy">
  <property name="transactionManager" ref="jmsTransactionManager"/>
  <property name="propagationBehaviorName" value="PROPAGATION_REQUIRES_NEW"/>
</bean>

```

And the Java DSL is a bit simpler now:

```

Policy required = bean(SpringTransactionPolicy.class, "PROPAGATION_REQUIRED");

```

## Database Sample

In this sample we want to ensure that two endpoints is under transaction control. These two endpoints inserts data into a database.

The sample is in its full as a unit test.

First of all we setup the usual spring stuff in its configuration file. Here we have defined a DataSource to the HSQLDB and a most importantly the Spring DataSource TransactionManager that is doing the heavy lifting of ensuring our transactional policies. You are of course free to use any of the Spring based TransactionManager, eg. if you are in a full blown J2EE container you could use JTA or the WebLogic or WebSphere specific managers.

We use the required transaction policy that we define as the PROPOGATION\_REQUIRED spring bean. And as last we have our book service bean that does the business logic and inserts data in the database as our core business logic.

```
<!-- datasource to the database -->
<bean id="dataSource"
class="org.springframework.jdbc.datasource.DriverManagerDataSource">
  <property name="driverClassName" value="org.hsqldb.jdbcDriver"/>
  <property name="url" value="jdbc:hsqldb:mem:camel"/>
  <property name="username" value="sa"/>
  <property name="password" value=""/>
</bean>

<!-- spring transaction manager -->
<bean id="txManager"
class="org.springframework.jdbc.datasource.DataSourceTransactionManager">
  <property name="dataSource" ref="dataSource"/>
</bean>

<!-- policy for required transaction used in our Camel routes -->
<bean id="PROPAGATION_REQUIRED"
class="org.apache.camel.spring.spi.SpringTransactionPolicy">
  <property name="transactionManager" ref="txManager"/>
</bean>

<!-- bean for book business logic -->
<bean id="bookService" class="org.apache.camel.spring.interceptor.BookService">
  <property name="dataSource" ref="dataSource"/>
</bean>
```

In our Camel route that is Java DSL based we setup the transactional policy, wrapped as a Policy.

```
// Notice that we use the SpringRouteBuilder that has a few more features than
// the standard RouteBuilder
return new SpringRouteBuilder() {
  public void configure() throws Exception {
    // setup the transaction policy
    SpringTransactionPolicy required = context.getRegistry()
      .lookup("PROPAGATION_REQUIRED", SpringTransactionPolicy.class);
```

```

// use this error handler instead of DeadLetterChannel that is the default
// Notice: transactionErrorHandler is in SpringRouteBuilder
if (useTransactionErrorHandler) {
    // useTransactionErrorHandler is only used for unit testing to reuse code
    // for doing a 2nd test without this transaction error handler, so ignore
    // this. For spring based transaction, end users are encouraged to use the
    // transaction error handler instead of the default DeadLetterChannel.
    errorHandler(transactionErrorHandler(required).
        // notice that the builder has builder methods for chained
configuration
        delay(5 * 1000L));
}

```

Then we are ready to define our Camel routes. We have two routes: 1 for success conditions, and 1 for a forced rollback condition.

This is after all based on a unit test.

```

// set the required policy for this route
from("direct:okay").policy(required).
    setBody(constant("Tiger in Action")).beanRef("bookService").
    setBody(constant("Elephant in Action")).beanRef("bookService");

// set the required policy for this route
from("direct:fail").policy(required).
    setBody(constant("Tiger in Action")).beanRef("bookService").
    setBody(constant("Donkey in Action")).beanRef("bookService");

```

As its a unit test we need to setup the database and this is easily done with Spring JdbcTemplate

```

// create database and insert dummy data
final DataSource ds = getMandatoryBean(DataSource.class, "dataSource");
jdbc = new JdbcTemplate(ds);
jdbc.execute("create table books (title varchar(50))");
jdbc.update("insert into books (title) values (?)", new Object[] {"Camel in Action"});

```

And our core business service, the book service, will accept any books except the Donkeys.

```

public class BookService {

    private SimpleJdbcTemplate jdbc;

    public BookService() {
    }

    public void setDataSource(DataSource ds) {
        jdbc = new SimpleJdbcTemplate(ds);
    }

    public void orderBook(String title) throws Exception {
        if (title.startsWith("Donkey")) {
            throw new IllegalArgumentException("We don't have Donkeys, only Camels");
        }

        // create new local datasource to store in DB
        jdbc.update("insert into books (title) values (?)", title);
    }
}

```

```
}  
}
```

Then we are ready to fire the tests. First to commit condition:

Error formatting macro: snippet: java.lang.IllegalArgumentException: Invalid url: must begin with a configured prefix.

And lastly the rollback condition since the 2nd book is a Donkey book:

```
public void testTransactionRollback() throws Exception {  
    try {  
        template.sendBody("direct:fail", "Hello World");  
    } catch (RuntimeException e) {  
        // expected as we fail  
        assertTrue(e.getCause() instanceof IllegalArgumentException);  
        assertEquals("We don't have Donkeys, only Camels", e.getCause().getMessage());  
    }  
  
    int count = jdbc.queryForInt("select count(*) from books");  
    assertEquals("Number of books", 1, count);  
}
```

## JMS Sample

In this sample we want to listen for messages on a queue and process the messages with our business logic java code and send them along. Since its based on a unit test the destination is a mock endpoint.

This time we want to setup the camel context and routes using the Spring XML syntax.

```
<!-- here we define our camel context -->  
<camel:camelContext id="myroutes">  
    <!-- and now our route using the XML syntax -->  
    <camel:route>  
        <!-- 1: from the jms queue -->  
        <camel:from uri="activemq:queue:okay"/>  
        <!-- 2: setup the transactional boundaries to require a transaction -->  
        <camel:policy ref="PROPAGATION_REQUIRED"/>  
        <!-- 3: call our business logic that is myProcessor -->  
        <camel:process ref="myProcessor"/>  
        <!-- 4: if success then send it to the mock -->  
        <camel:to uri="mock:result"/>  
    </camel:route>  
</camel:camelContext>
```

```
<!-- this bean is our business logic -->  
<bean id="myProcessor"  
class="org.apache.camel.component.jms.tx.JMSTransactionalClientTest$MyProcessor"/>
```

Since the rest is standard XML stuff its nothing fancy now for the reader:

```
<bean id="jmsConnectionFactory" class="org.apache.activemq.ActiveMQConnectionFactory">  
    <property name="brokerURL"  
value="vm://localhost?broker.persistent=false&broker.useJmx=false"/>  
</bean>
```



```

<bean id="jmsTransactionManager"
class="org.springframework.jms.connection.JmsTransactionManager">
    <property name="connectionFactory" ref="jmsConnectionFactory"/>
</bean>

<bean id="jmsConfig" class="org.apache.camel.component.jms.JmsConfiguration">
    <property name="connectionFactory" ref="jmsConnectionFactory"/>
    <property name="transactionManager" ref="jmsTransactionManager"/>
    <property name="transacted" value="true"/>
    <property name="transactedInOut" value="true"/>
    <property name="concurrentConsumers" value="1"/>
</bean>

<bean id="activemq" class="org.apache.camel.component.jms.JmsComponent">
    <property name="configuration" ref="jmsConfig"/>
</bean>

<bean id="PROPAGATION_REQUIRED"
class="org.apache.camel.spring.spi.SpringTransactionPolicy">
    <constructor-arg>
        <bean class="org.springframework.transaction.support.TransactionTemplate">
            <property name="transactionManager" ref="jmsTransactionManager"/>
        </bean>
    </constructor-arg>
</bean>

```

Our business logic is set to handle the incoming messages and fail the first two times. When its a success it responds with a Bye World message.

```

public static class MyProcessor implements Processor {
    private int count;

    public void process(Exchange exchange) throws Exception {
        if (++count <= 2) {
            throw new IllegalArgumentException("Forced Exception number " + count + ",
please retry");
        }
        exchange.getIn().setBody("Bye World");
        exchange.getIn().setHeader("count", count);
    }
}

```

And our unit test is tested with this java code. Notice that we expect the Bye World message to be delivered at the 3rd attempt.

```

MockEndpoint mock = getMockEndpoint("mock:result");
mock.expectedMessageCount(1);
mock.expectedBodiesReceived("Bye World");
// success at 3rd attempt
mock.message(0).header("count").isEqualTo(3);

template.sendBody("activemq:queue:okay", "Hello World");

mock.assertIsSatisfied();

```

## Spring based configuration

In Camel 1.4 we have introduced the concept of configuration of the error handlers using spring XML configuration. The sample below demonstrates that you can configure transaction error handlers in Spring XML as spring beans. These can then be set as global, per route based or per policy based error handler. The latter has been demonstrated in the samples above. This sample is the database sample configured in Spring XML.

Notice that we have defined two error handler, one per route. The first route uses the transaction error handler, and the 2nd uses no error handler at all.

```
<!-- here we define our camel context -->
<camel:camelContext id="myroutes">

  <!-- first route with transaction error handler -->
  <!-- here we refer to our transaction error handler we define in this Spring XML
file -->
  <!-- in this route the transactionErrorHandler is used -->
  <camel:route errorHandlerRef="transactionErrorHandler">
    <!-- 1: from the jms queue -->
    <camel:from uri="activemq:queue:okay"/>
    <!-- 2: setup the transactional boundaries to require a transaction -->
    <camel:policy ref="required"/>
    <!-- 3: call our business logic that is myProcessor -->
    <camel:process ref="myProcessor"/>
    <!-- 4: if success then send it to the mock -->
    <camel:to uri="mock:result"/>
  </camel:route>

  <!-- 2nd route with no error handling -->
  <!-- this route doesn't use error handler, in fact the spring bean with id
noErrorHandler -->
  <camel:route errorHandlerRef="noErrorHandler">
    <camel:from uri="activemq:queue:bad"/>
    <camel:to uri="log:bad"/>
  </camel:route>

</camel:camelContext>
```

The following snippet is the Spring XML configuration to setup the error handlers in pure spring XML:

```
<!-- camel policy we refer to in our route -->
<bean id="required" class="org.apache.camel.spring.spi.SpringTransactionPolicy">
  <property name="template" ref="PROPAGATION_REQUIRED"/>
</bean>

<!-- the standard spring transaction template for required -->
<bean id="PROPAGATION_REQUIRED"
class="org.springframework.transaction.support.TransactionTemplate">
  <property name="transactionManager" ref="jmsTransactionManager"/>
</bean>

<!-- the transaction error handle we refer to from the route -->
<bean id="transactionErrorHandler"
```

```

class="org.apache.camel.spring.spi.TransactionErrorHandlerBuilder">
  <property name="transactionTemplate" ref="PROPAGATION_REQUIRED"/>
  <!-- here we refer to the configurations of the error handler -->
  <property name="delayPolicy" ref="delayPolicyConfig"/>
</bean>

<!-- configuration of the transaction error handler -->
<bean id="delayPolicyConfig" class="org.apache.camel.processor.DelayPolicy">
  <!-- wait 5 seconds between redelivery -->
  <property name="delay" value="5000"/>
</bean>

<!-- the no error handler -->
<bean id="noErrorHandler" class="org.apache.camel.builder.NoErrorHandlerBuilder"/>

```

## DelayPolicy

DelayPolicy is a new policy introduced in Camel 1.5, to replaces the RedeliveryPolicy used in Camel 1.4. Notice the transactionErrorHandler can be configured with a DelayPolicy to set a fixed delay in millis between each redelivery attempt. Camel does this by sleeping the delay until transaction is marked for rollback and the caused exception is rethrown.

This allows a simple redelivery interval that can be configured for development mode or light production to avoid a rapid redelivery strategy that can exhaust a system that constantly fails.

**We strongly recommend that you configure the backing system for correct redelivery policy in your environment.**

## See Also

- JMS
- Dead Letter Channel
- Error Handler

## Using This Pattern

If you would like to use this EIP Pattern then please read the Getting Started, you may also find the Architecture useful particularly the description of Endpoint and URIs. Then you could try out some of the Examples first before trying this pattern out.

## Messaging Gateway

Camel has several endpoint components that support the Messaging Gateway from the EIP patterns.

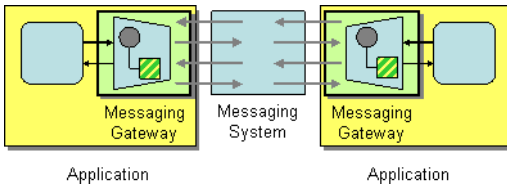

Components like Bean, CXF and Pojo provide a way to bind a Java interface to the message exchange.

### See Also

- Bean
- Pojo
- CXF

### Using This Pattern

If you would like to use this EIP Pattern then please read the Getting Started, you may also find the Architecture useful particularly the description of Endpoint and URIs. Then you could try out some of the Examples first before trying this pattern out.

### Service Activator

Camel has several endpoint components that support the Service Activator from the EIP patterns.

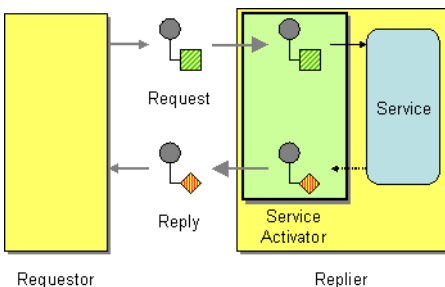

Components like Bean, CXF and Pojo provide a way to bind the message exchange to a Java interface/service where the route defines the endpoints and wires it up to the bean.

In addition you can use the Bean Integration to wire messages to a bean using annotation.

### See Also

- Bean
- Pojo

- CXF

## Using This Pattern

If you would like to use this EIP Pattern then please read the Getting Started, you may also find the Architecture useful particularly the description of Endpoint and URIs. Then you could try out some of the Examples first before trying this pattern out.

## SYSTEM MANAGEMENT

### Wire Tap

The Wire Tap from the EIP patterns allows you to route messages to a separate tap location while it is forwarded to the ultimate destination.

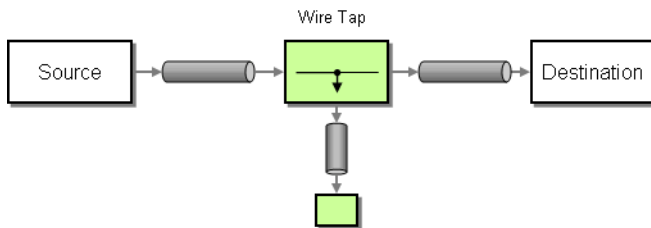

The following example shows how to route a request from an input **queue:a** endpoint to the wire tap location **queue:tap** it is received by **queue:b**

#### Using the Fluent Builders

```
RouteBuilder builder = new RouteBuilder() {
    public void configure() {
        from("seda:a").multicast().to("seda:tap", "seda:b");
    }
};
```

#### Using the Spring XML Extensions

```
<camelContext id="camel" xmlns="http://camel.apache.org/schema/spring">
  <route>
    <from uri="seda:a"/>
    <multicast>
      <to uri="seda:tap"/>
      <to uri="seda:b"/>
    </multicast>
  </route>
</camelContext>
```

## **Further Example**

For another example of this pattern in use you could look at the wire tap test case.

## **Using This Pattern**

If you would like to use this EIP Pattern then please read the Getting Started, you may also find the Architecture useful particularly the description of Endpoint and URIs. Then you could try out some of the Examples first before trying this pattern out.

# Component Appendix

There now follows the documentation on each Camel component.

## ACTIVEMQ COMPONENT

The ActiveMQ component allows messages to be sent to a JMS Queue or Topic; or messages to be consumed from a JMS Queue or Topic using Apache ActiveMQ.

This component is based on the JMS Component and uses Spring's JMS support for declarative transactions, using Spring's `JmsTemplate` for sending and a `MessageListenerContainer` for consuming.

To use this component make sure you have the `activemq.jar` or `activemq-core.jar` on your classpath along with any Camel dependencies such as `camel-core.jar`, `camel-spring.jar` and `camel-jms.jar`.

### URI format

```
activemq:[topic:]destinationName
```

So for example to send to queue `FOO.BAR` you would use

```
activemq:FOO.BAR
```

You can be completely specific if you wish via

```
activemq:queue:FOO.BAR
```

If you want to send to a topic called `Stocks.Prices` then you would use

```
activemq:topic:Stocks.Prices
```

### Configuring the Connection Factory

The following test case shows how to add an `ActiveMQComponent` to the `CamelContext` using the `activeMQComponent()` method while specifying the `brokerURL` used to connect to ActiveMQ

```
camelContext.addComponent("activemq",  
    activeMQComponent("vm://localhost?broker.persistent=false"));
```

## Configuring the Connection Factory using Spring XML

You can configure the ActiveMQ broker URL on the ActiveMQComponent as follows

```
<beans xmlns="http://www.springframework.org/schema/beans"
       xmlns:xsi="http://www.w3.org/2001/XMLSchema-instance"
       xsi:schemaLocation="
         http://www.springframework.org/schema/beans http://www.springframework.org/
         schema/beans/spring-beans-2.0.xsd
         http://camel.apache.org/schema/spring http://camel.apache.org/schema/spring/
         camel-spring.xsd">

  <camelContext xmlns="http://camel.apache.org/schema/spring">
    </camelContext>

  <bean id="activemq" class="org.apache.activemq.camel.component.ActiveMQComponent">
    <property name="brokerURL" value="tcp://somehost:61616"/>
  </bean>

</beans>
```

## Invoking MessageListener POJOs in a Camel route

The ActiveMQ component also provides a helper Type Converter from a JMS MessageListener to a Processor. This means that the Bean component is capable of invoking any JMS MessageListener bean directly inside any route.

So for example you can create a MessageListener in JMS like this....

```
public class MyListener implements MessageListener {
    public void onMessage(Message jmsMessage) {
        // ...
    }
}
```

Then use it in your Camel route as follows

```
from("file://foo/bar").
    bean(MyListener.class);
```

i.e. you can reuse any of the Camel Components and easily integrate them into your JMS MessageListener POJO!

## Getting Component JAR

The ActiveMQ Camel component is released with the ActiveMQ project itself.

For Maven 2 users you simply just need to add the following dependency to your project.



## ActiveMQ 5.2 or later

```
<dependency>
  <groupId>org.apache.activemq</groupId>
  <artifactId>activemq-camel</artifactId>
  <version>5.2.0</version>
</dependency>
```

## ActiveMQ 5.1.0

For 5.1.0 its in the activemq-core library

```
<dependency>
  <groupId>org.apache.activemq</groupId>
  <artifactId>activemq-core</artifactId>
  <version>5.1.0</version>
</dependency>
```

Alternatively you can download the component jar directly from the Maven repository:

- activemq-camel-5.2.0.jar
- activemq-core-5.1.0.jar

## ActiveMQ 4.x

For this version you must use the JMS component instead. Please be careful to use a pooling connection factory as described in the [JmsTemplate Gotchas](#)

### See Also

- [Configuring Camel](#)
- [Component](#)
- [Endpoint](#)
- [Getting Started](#)

## ACTIVEMQ JOURNAL COMPONENT

The ActiveMQ Journal Component allows messages to be stored in a rolling log file and then consumed from that log file. The journal aggregates and batches up concurrent writes so that the overhead of writing and waiting for the disk sync is relatively constant regardless of how many concurrent writes are being done. Therefore, this component supports and encourages you to use multiple concurrent producers to the same journal endpoint.

Each journal endpoint uses a different log file and therefore write batching (and the associated performance boost) does not occur between multiple endpoints.

This component only supports 1 active consumer on the endpoint. After the message is processed by the consumer's processor, the log file is marked and only subsequent messages in the log file will get delivered to consumers.

## URI format

```
activemq.journal:directory-name[?options]
```

So for example to send to the journal located in the /tmp/data directory you would use

```
activemq.journal:/tmp/data
```

## Options

Name	Default Value	Description
syncConsume	false	If set to true, when the journal is marked after a message is consumed, wait till the Operating System has verified the mark update is safely stored on disk
syncProduce	true	If set to true, wait till the Operating System has verified the message is safely stored on disk

## Expected Exchange Data Types

The consumer of a Journal endpoint generates DefaultExchange objects with the in message :

- header "journal" : set to the endpoint uri of the journal the message came from
- header "location" : set to a Location which identifies where the record was stored on disk
- body : set to ByteSequence which contains the byte array data of the stored message

The producer to a Journal endpoint expects an Exchange with an In message where the body can be converted to a ByteSequence or a byte[].

## See Also

- Configuring Camel
- Component
- Endpoint
- Getting Started

## AMQP

The AMQP component supports the AMQP protocol via the Qpid project.

## URI format

```
amqp:[queue:][topic:]destinationName[?option1=value[&option2=value2]]
```

You can specify all of the various configuration options of the JMS component after the destination name.

## See Also

- [Configuring Camel](#)
- [Component](#)
- [Endpoint](#)
- [Getting Started](#)

## ATOM COMPONENT

The **atom** component is used for polling atom feeds.

Camel will default poll the feed every 60th seconds.

**Note:** The component currently only supports polling (consuming) feeds.

## URI format

```
atom://atomUri
```

Where **atomUri** is the URI to the atom feed to poll.

## Options

Property	Default	Description
splitEntries	true	If <b>true</b> Camel will poll the feed and for the subsequent polls return each entry poll by poll. If the feed contains 7 entries then Camel will return the first entry on the first poll, the 2nd entry on the next poll, until no more entries where as Camel will do a new update on the feed. If <b>false</b> then Camel will poll a fresh feed on every invocation.
filter	true	Is only used by the split entries to filter the entries to return. Camel will default use the UpdateDateFilter that only return new entries from the feed. So the client consuming from the feed never receives the same entry more than once. The filter will return the entries ordered by the newest last.

lastUpdate	null	Is only used by the filter, as the starting timestamp for selection never entries (uses the entry.updated timestamp). Syntax format is: yyyy-MM-ddTHH:MM:ss. Example: 2007-12-24T17:45:59.
feedHeader	true	Sets whether to add the Abdera Feed object as a header.
sortEntries	false	If splitEntries is true, this sets whether to sort those entries by updated date.
consumer.delay	60000	Delay in millis between each poll
consumer.initialDelay	1000	Millis before polling starts
consumer.userFixedDelay	false	<b>true</b> to use fixed delay between pools, otherwise fixed rate is used. See ScheduledExecutorService in JDK for details.

### Exchange data format

Camel will set the in body on the returned Exchange with the entries. Depending on the splitEntries flag Camel will either return one Entry or a List<Entry>.

Option	Value	Behavior
splitEntries	true	Only a single entry from the currently being processed feed is set: <code>exchange.in.body(Entry)</code>
splitEntries	false	The entire list of entries from the feed is set: <code>exchange.in.body(List&lt;Entry&gt;)</code>

Camel can set the Feed object on the in header (see feedHeader option to disable this):

```
exchange.in.header("org.apache.camel.component.atom.feed", feed)
```

### Samples

In this sample we poll James Strahams blog.

```
from("atom://http://macstrac.blogspot.com/feeds/posts/default").to("seda:feeds");
```

In this sample we want to filter only good blogs we like to a seda queue. The sample also shows how to setup Camel standalone, not running in any Container or using Spring.

```
// This is the CamelContext that is the heart of Camel
private CamelContext context;

// We use a simple Hashtable for our bean registry. For more advanced usage Spring is
```

```

supported out-of-the-box
private Hashtable beans = new Hashtable();

// We initialize Camel
private void setupCamel() throws Exception {
    // First we register a blog service in our bean registry
    beans.put("blogService", new BlogService());

    // Then we create the camel context with our bean registry
    context = new DefaultCamelContext(new
CamelInitialContextFactory().getInitialContext(beans));

    // Then we add all the routes we need using the route builder DSL syntax
    context.addRoutes(createRouteBuilder());

    // And finally we must start Camel to let the magic routing begins
    context.start();
}

/**
 * This is the route builder where we create our routes in the advanced Camel DSL
syntax
 */
protected RouteBuilder createRouteBuilder() throws Exception {
    return new RouteBuilder() {
        public void configure() throws Exception {
            // We pool the atom feeds from the source for further processing in the
seda queue
            // we set the delay to 1 second for each pool as this is a unit test also
and we can
            // not wait the default poll interval of 60 seconds.
            // Using splitEntries=true will during polling only fetch one Atom Entry
at any given time.
            // As the feed.atom file contains 7 entries, using this will require 7
polls to fetch the entire
            // content. When Camel have reach the end of entries it will refresh the
atom feed from URI source
            // and restart - but as Camel by default uses the UpdatedDateFilter it
will only deliver new
            // blog entries to "seda:feeds". So only when James Straham updates his
blog with a new entry
            // Camel will create an exchange for the seda:feeds.
            from("atom:file:src/test/data/
feed.atom?splitEntries=true&consumer.delay=1000").to("seda:feeds");

            // From the feeds we filter each blot entry by using our blog service class
            from("seda:feeds").filter().method("blogService",
"goodBlog").to("seda:goodBlogs");

            // And the good blogs is moved to a mock queue as this sample is also used
for unit testing
            // this is one of the strengths in Camel that you can also use the mock
endpoint for your
            // unit tests
            from("seda:goodBlogs").to("mock:result");
        }
    }
}

```

```

    };
}

/**
 * This is the actual junit test method that does the assertion that our routes is
 * working
 * as expected
 */
public void testFiltering() throws Exception {
    // Get the mock endpoint
    MockEndpoint mock = context.getEndpoint("mock:result", MockEndpoint.class);

    // There should be two good blog entries from the feed
    mock.expectedMessageCount(2);

    // Asserts that the above expectations is true, will throw assertions exception if
    it failed
    // Camel will default wait max 20 seconds for the assertions to be true, if the
    conditions
    // is true sooner Camel will continue
    mock.assertIsSatisfied();
}

/**
 * Services for blogs
 */
public class BlogService {

    /**
     * Tests the blogs if its a good blog entry or not
     */
    public boolean isGoodBlog(Exchange exchange) {
        Entry entry = exchange.getIn().getBody(Entry.class);
        String title = entry.getTitle();

        // We like blogs about Camel
        boolean good = title.toLowerCase().contains("camel");
        return good;
    }
}
}

```

## See Also

- [Configuring Camel](#)
- [Component](#)
- [Endpoint](#)
- [Getting Started](#)

## BEAN COMPONENT

The **bean:** component binds beans to Camel message exchanges.

## URI format

```
bean:someName[?options]
```

Where **someName** can be any string which is used to lookup the bean in the Registry

## Options

Name	Type	Default	Description
method	String	null	The method name that bean will be invoked. If not provided Camel will try to pick the method itself. In case of ambiguity an exception is thrown. See Bean Binding for more details.
cache	boolean	false	If enabled Camel will cache the result of the first Registry lookup. Cache can be enabled if the bean in the Registry is defined as a singleton scope.
multiParameterArray	boolean	false	<b>Camel 1.5:</b> How to treat the parameters which are passed from the message body, if it is true, the in message body should be the an array of parameters.

## Using

The object instance that is used to consume messages must be explicitly registered with the Registry. For example if you are using Spring you must define the bean in the spring.xml; or if you don't use Spring then put the bean in JNDI.

```
// lets populate the context with the services we need
// note that we could just use a spring.xml file to avoid this step
JndiContext context = new JndiContext();
context.bind("bye", new SayService("Good Bye!"));

CamelContext camelContext = new DefaultCamelContext(context);
```

Once an endpoint has been registered, you can build Camel routes that use it to process exchanges.

```
// lets add simple route
camelContext.addRoutes(new RouteBuilder() {
    public void configure() {
        from("direct:hello").to("bean:bye");
    }
});
```

A **bean:** endpoint cannot be defined as the input to the route; i.e. you cannot consume from it, you can only route from some inbound message Endpoint to the bean endpoint as output. So consider using a **direct:** or **queue:** endpoint as the input.

You can use the `createProxy()` methods on `ProxyHelper` to create a proxy that will generate `BeanExchanges` and send them to any endpoint:

```
Endpoint endpoint = camelContext.getEndpoint("direct:hello");
ISay proxy = ProxyHelper.createProxy(endpoint, ISay.class);
String rc = proxy.say();
assertEquals("Good Bye!", rc);
```

And the same route using Spring DSL:

```
<route>
  <from uri="direct:hello">
    <to uri="bean:bye"/>
  </route>
```

## Bean as endpoint

Camel also supports invoking Bean as an Endpoint. In the route below:

```
<camelContext id="camel" xmlns="http://camel.apache.org/schema/spring">
  <route>
    <from uri="direct:start"/>
    <to uri="myBean"/>
    <to uri="mock:results"/>
  </route>
</camelContext>

<bean id="myBean" class="org.apache.camel.spring.bind.ExampleBean"/>
```

What happens is that when the exchange is routed to the `myBean` Camel will use the `Bean Binding` to invoke the bean.

The source for the bean is just a plain POJO:

```
public class ExampleBean {

    public String sayHello(String name) {
        return "Hello " + name + "!";
    }
}
```

Camel will use `Bean Binding` to invoke the `sayHello` method, by converting the `Exchange IN` body to the `String` type and store the output of the method on the `Exchange OUT` body.

## Bean Binding

How bean methods are chosen to be invoked (if they are not specified explicitly via the **method** parameter) and how parameter values are constructed from the `Message` are all



defined by the Bean Binding mechanism which is used throughout all of the various Bean Integration mechanisms in Camel.

## See Also

- [Configuring Camel](#)
- [Component](#)
- [Endpoint](#)
- [Getting Started](#)
- [Bean Binding](#)
- [Bean Integration](#)

## BROWSE COMPONENT

### Available as of Camel 2.0

The Browse component provides a simple `BrowsableEndpoint` which can be useful for testing, visualisation tools or debugging. The exchanges sent to the endpoint are all available to be browsed.

### URI format

```
browse:someName
```

Where **someName** can be any string to uniquely identify the endpoint.

### Sample

In the route below we have the list component to be able to browse the Exchanges that is passed through:

```
from("activemq:order.in").to("browse:orderReceived").to("bean:processOrder");
```

Then we will be able to inspect the received exchanges from java code:

```
private CamelContext context;

public void inspectReceivedOrders() {
    BrowsableEndpoint browse = context.getEndpoint("browse:orderReceived",
    BrowsableEndpoint.class);
    List<Exchange> exchanges = browse.getExchanges();
    ...
    // then we can inspect the list of received exchanges from Java
    for (Exchange exchange : exchanges) {
        String payload = exchange.getIn().getBody();
        ...
    }
}
```

## See Also

- [Configuring Camel](#)
- [Component](#)
- [Endpoint](#)
- [Getting Started](#)

## COMETD COMPONENT

The **cometd** component is a transport for working with the jetty implementation of the cometd/bayeux protocol.

Using this component in combination with the dojo toolkit library it's possible to push Camel messages directly into the browser using an AJAX based mechanism.

### URI format

```
cometd://host:port/channelname
```

The channelname represents a topic that can be subscribed by the Camel endpoints.

### Examples

```
cometd://localhost:8080/service/mychannel
```

```
cometds://localhost:8443/service/mychannel
```

where cometds represents an SSL configured endpoint.

See this blog entry by David Greco whom contributed this component to Apache Camel, for a full sample.

### Options

Name	Default Value	Description
resourceBase		It's the root directory for the web resources
timeout	240000	The server side poll timeout in milliseconds. This is how long the server will hold a reconnect request before responding.
interval	0	The client side poll timeout in milliseconds. How long a client will wait between reconnects
maxInterval	30000	The max client side poll timeout in milliseconds. A client will be removed if a connection is not received in this time.

multiFrameInterval	1500	the client side poll timeout if multiple connections are detected from the same browser
jsonCommented	true	If "true" then the server will accept JSON wrapped in a comment and will generate JSON wrapped in a comment. This is a defence against Ajax Hijacking
logLevel	1	0=none, 1=info, 2=debug

## See Also

- [Configuring Camel](#)
- [Component](#)
- [Endpoint](#)
- [Getting Started](#)

## CXF COMPONENT

The **cxf** component provides integration with Apache CXF for connecting to JAX-WS services hosted in CXF.

Maven users will need to add the following dependency to their pom.xml for this component:

```
<dependency>
  <groupId>org.apache.camel</groupId>
  <artifactId>camel-cxf</artifactId>
  <version>x.x.x</version> <!-- use the same version as your Camel core version -->
</dependency>
```

## URI format

```
cxf://address?options
```

Where **address** represents the CXF endpoint's address

```
cxf:bean:cxfEndpoint
```

Where **cxfEndpoint** represents the spring bean's name which presents the CXF endpoint

For either style above, you can append options to the URI as follows:

```
cxf:bean:cxfEndpoint?wsdlURL=wsdl/hello_world.wsdl&dataFormat=PAYLOAD
```

## Options

Name	Description	Example
------	-------------	---------

wSDLURL	The location of the WSDL.	file://local/wSDL/hello.wSDL or wSDL/hello.wSDL
serviceClass	<p>The name of the SEI(Service Endpoint Interface) class. This class can have but does not require JSR181 annotations.</p> <p><b>Since 2.0</b>, it is possible to use # notation to reference a serviceClass object instance from the registry. E.g. serviceClass=#beanName. <b>Please be advised that the referenced object cannot be a Proxy (Spring AOP Proxy is OK)</b> as it relies on Object.getClass().getName() method for non Spring AOP Proxy.</p>	org.apache.camel.Hello
serviceClassInstance	<p><b>In 1.6 or later (will be deprecated in 2.0)</b>, serviceClassInstance works like serviceClass=#beanName, which looks up a serviceObject instance from the registry.</p>	serviceClassInstance=beanName
serviceName	The service name this service is implementing, it maps to the wSDL:service@name.	{http://org.apache.camel} ServiceName
portName	The port name this service is implementing, it maps to the wSDL:port@name.	{http://org.apache.camel} PortName
dataFormat	Which data type messages the CXF endpoint supports	POJO, PAYLOAD, MESSAGE
wrapped	Which kind of operation that CXF endpoint producer will invoke	true, false
setDefaultBus	Will set the default bus when CXF endpoint create a bus by itself	true, false
bus	New in 2.0, use # notation to reference a bus object from the registry. The referenced object must be an instance of org.apache.cxf.Bus.	bus=#busName

cxfBinding	New in 2.0, use # notation to reference a CXF binding object from the registry. The referenced object must be an instance of org.apache.camel.component.cxf.CxfBinding.	cxfBinding=#bindingName
headerFilterStrategy	New in 2.0, use # notation to reference a header filter strategy object from the registry. The referenced object must be an instance of org.apache.camel.spi.HeaderFilterStrategy.	headerFilterStrategy=#strategyName

The serviceName and portName are QNames, so if you provide them be sure to prefix them with their {namespace} as shown in the examples above.

**NOTE** From CAMEL 1.5.1, the serviceClass for CXF producer (i.e. the "to" endpoint) should be Java interface.

## The descriptions of the dataformats

DataFormat	Description
POJO	POJOs (Plain old Java objects) are the Java parameters to the method being invoked on the target server.
PAYLOAD	PAYLOAD is the message payload (the contents of the soap:body) after message configuration in the CXF endpoint is applied.
MESSAGE	MESSAGE is the raw message that is received from the transport layer.

## Configure the CXF endpoints with spring

You can configure the CXF endpoint with the below spring configuration file, and you can also embed the endpoint into the camelContext tags.

```
<beans xmlns="http://www.springframework.org/schema/beans"
  xmlns:xsi="http://www.w3.org/2001/XMLSchema-instance"
  xmlns:cxf="http://activemq.apache.org/camel/schema/cxfEndpoint"

  xsi:schemaLocation="
    http://www.springframework.org/schema/beans http://www.springframework.org/
schema/beans/spring-beans-2.0.xsd
    http://camel.apache.org/schema/cxfEndpoint http://camel.apache.org/schema/cxf/
cxfEndpoint.xsd
    http://camel.apache.org/schema/spring http://camel.apache.org/schema/spring/
camel-spring.xsd
  ">

  <cxf:cxfEndpoint id="routerEndpoint" address="http://localhost:9003/CamelContext/
RouterPort"
```

```

        serviceClass="org.apache.hello_world_soap_http.GreeterImpl" />

    <cxf:cxfEndpoint id="serviceEndpoint" address="http://localhost:9000/SoapContext/
SoapPort"

        wsdlURL="testutils/hello_world.wsdl"
        serviceClass="org.apache.hello_world_soap_http.Greeter"
        endpointName="s:SoapPort"
        serviceName="s:SOAPService"
        xmlns:s="http://apache.org/hello_world_soap_http" />

    <camelContext id="camel" xmlns="http://activemq.apache.org/camel/schema/spring">
    <route>
    <from uri="cxf:bean:routerEndpoint" />
    <to uri="cxf:bean:serviceEndpoint" />
    </route>
    </camelContext>

</beans>

```

Be sure to include the JAX-WS `schemaLocation` attribute specified on the root beans element. This allows CXF to validate the file and is required. Also note the namespace declarations at the end of the `<cxf:cxfEndpoint/>` tag--these are required because the combined "{namespace}localName" syntax is presently not supported for this tag's attribute values.

The `cxf:cxfEndpoint` element supports many additional attributes:

Name	Value
PortName	The endpoint name this service is implementing, it maps to the <code>wsdl:port@name</code> . In the format of "ns:PORT_NAME" where ns is a namespace prefix valid at this scope.
serviceName	The service name this service is implementing, it maps to the <code>wsdl:service@name</code> . In the format of "ns:SERVICE_NAME" where ns is a namespace prefix valid at this scope.
wsdlURL	The location of the WSDL. Can be on the classpath, file system, or be hosted remotely.
bindingId	The bindingId for the service model to use
address	The service publish address
bus	The bus name that will be used in the jaxws endpoint.
serviceClass	The class name of the SEI(Service Endpoint Interface) class which could have JSR181 annotation or not

It also supports many child elements:

Name	Value
------	-------

cxf:inInterceptors	The incoming interceptors for this endpoint. A list of <bean>s or <ref>s.
cxf:inFaultInterceptors	The incoming fault interceptors for this endpoint. A list of <bean>s or <ref>s.
cxf:outInterceptors	The outgoing interceptors for this endpoint. A list of <bean>s or <ref>s.
cxf:outFaultInterceptors	The outgoing fault interceptors for this endpoint. A list of <bean>s or <ref>s.
cxf:properties	A properties map which should be supplied to the JAX-WS endpoint. See below.
cxf:handlers	A jaxws handler list which should be supplied to the JAX-WS endpoint. See below.
cxf:dataBinding	You can specify the which DataBinding will be use in the endpoint, This can be supplied using the Spring <bean class="MyDataBinding"/> syntax.
cxf:binding	You can specify the BindingFactory for this endpoint to use. This can be supplied using the Spring <bean class="MyBindingFactory"/> syntax.
cxf:features	The features that hold the interceptors for this endpoint. A list of <bean>s or <ref>s
cxf:schemaLocations	The schema locations for endpoint to use. A list of <schemaLocation>s
cxf:serviceFactory	The service factory for this endpoint to use. This can be supplied using the Spring <bean class="MyServiceFactory"/> syntax

You can find more advanced examples which show how to provide interceptors , properties and handlers here:

<http://cwiki.apache.org/CXF20DOC/jax-ws-configuration.html>

### NOTE

You can use cxf:properties to set the camel-cxf endpoint's dataFormat and setDefaultBus properties from spring configuration file.

```
<cxf:cxfEndpoint id="testEndpoint" address="http://localhost:9000/router"
  serviceClass="org.apache.camel.component.cxf.HelloService"
  endpointName="s:PortName"
  serviceName="s:ServiceName"
  xmlns:s="http://www.example.com/test">
  <cxf:properties>
    <entry key="dataFormat" value="MESSAGE"/>
    <entry key="setDefaultBus" value="true"/>
  </cxf:properties>
</cxf:cxfEndpoint>
```

```
</cxf:properties>
</cxf:cxfEndpoint>
```

## How to let camel-cxf component to use log4j instead of java.util.logging

CXF's default logger is using java.util.logging, if you want to change it to log4j. Here is the instruction: Create a file, in the classpath, named META-INF/cxf/org.apache.cxf.logger. This file should contain the fully-qualified name of the class (org.apache.cxf.common.logging.Log4jLogger), with no comments, on a single line.

## How to consume the message from the camel-cxf endpoint in POJO data format

The camel-cxf endpoint consumer POJO data format is based on the cxf invoker, so the message header has a property with the name of CxfConstants.OPERATION\_NAME and the message body is a list of the SEI method parameters.

```
public class PersonProcessor implements Processor {

    private static final transient Log LOG = LogFactory.getLog(PersonProcessor.class);

    public void process(Exchange exchange) throws Exception {
        LOG.info("processing exchange in camel");

        BindingOperationInfo boi =
            (BindingOperationInfo)exchange.getProperty(BindingOperationInfo.class.toString());
        if (boi != null) {
            LOG.info("boi.isUnwrapped" + boi.isUnwrapped());
        }
        // Get the parameters list which element is the holder.
        MessageContentsList msgList = (MessageContentsList)exchange.getIn().getBody();
        Holder<String> personId = (Holder<String>)msgList.get(0);
        Holder<String> ssn = (Holder<String>)msgList.get(1);
        Holder<String> name = (Holder<String>)msgList.get(2);

        if (personId.value == null || personId.value.length() == 0) {
            LOG.info("person id 123, so throwing exception");
            // Try to throw out the soap fault message
            org.apache.camel.wsd1_first.types.UnknownPersonFault personFault =
                new org.apache.camel.wsd1_first.types.UnknownPersonFault();
            personFault.setPersonId("");
            org.apache.camel.wsd1_first.UnknownPersonFault fault =
                new org.apache.camel.wsd1_first.UnknownPersonFault("Get the null value
of person name", personFault);
            // Since camel has its own exception handler framework, we can't throw the
exception to trigger it
            // We just set the fault message in the exchange for camel-cxf component
handling
            exchange.getFault().setBody(fault);
        }

        name.value = "Bonjour";
    }
}
```



```

        ssn.value = "123";
        LOG.info("setting Bonjour as the response");
        // Set the response message, first element is the return value of the
operation,
        // the others are the holders of method parameters
        exchange.getOut().setBody(new Object[] {null, personId, ssn, name});
    }
}

```

## How to prepare the message for the camel-cxf endpoint in POJO data format

The camel-cxf endpoint producer is based on the cxf client API. First you need to specify the operation name in the message header, then add the method parameters into a list and set the message with this parameter list will be ok. The response message's body is a `messageContentsList`, you can get the result from that list.

**NOTE** After Camel 1.5, we change the message body from object array to message content list. If you still want to get the object array from the message body, you can get the body with this code `message.getbody(Object[].class)`

```

Exchange senderExchange = new DefaultExchange(context, ExchangePattern.InOut);
final List<String> params = new ArrayList<String>();
// Prepare the request message for the camel-cxf procedure
params.add(TEST_MESSAGE);
senderExchange.getIn().setBody(params);
senderExchange.getIn().setHeader(CxfConstants.OPERATION_NAME, ECHO_OPERATION);

Exchange exchange = template.send("direct:EndpointA", senderExchange);

org.apache.camel.Message out = exchange.getOut();
// The response message's body is a MessageContentsList which first element is the
return value of the operation,
// If there are some holder parameters, the holder parameter will be filled in the
reset of List.
// The result will be extract from the MessageContentsList with the String class type
MessageContentsList result = (MessageContentsList)out.getBody();
LOG.info("Received output text: " + result.get(0));
Map<String, Object> responseContext =
CastUtils.cast((Map)out.getHeader(Client.RESPONSE_CONTEXT));
assertNotNull(responseContext);
assertEquals("We should get the response context here", "UTF-8",
responseContext.get(org.apache.cxf.message.Message.ENCODING));
assertEquals("Reply body on Camel is wrong", "echo " + TEST_MESSAGE, result.get(0));

```

## How to deal with the message for the camel-cxf endpoint in PAYLOAD data format

PAYLOAD means you will get or set the payload message which has been take out the SOAP envelope from or into the CXF message. You can use the Header.HEADER\_LIST as the key to set or get the SOAP headers and use the List<Element> to set or get SOAP body elements.

**Change in 2.0**, CxfMessage.getBody() will return a org.apache.camel.component.cxf.CxfPayload object, which has getters for SOAP message headers and Body elements. This change enables decoupling the native CXF message from the Camel message.

```
from(routerEndpointURI).process(new Processor() {
    @SuppressWarnings("unchecked")
    public void process(Exchange exchange) throws Exception {
        CxfPayload<SoapHeader> payload = exchange.getIn().getBody(CxfPayload.class);
        List<Element> elements = payload.getBody();
        assertNotNull("We should get the elements here", elements);
        assertEquals("Get the wrong elements size", 1, elements.size());
        assertEquals("Get the wrong namespace URI", "http://camel.apache.org/pizza/
types",
            elements.get(0).getNamespaceURI());

        List<SoapHeader> headers = payload.getHeaders();
        assertNotNull("We should get the headers here", headers);
        assertEquals("Get the wrong headers size", headers.size(), 1);
        assertEquals("Get the wrong namespace URI",
            ((Element)headers.get(0).getObject()).getNamespaceURI(),
            "http://camel.apache.org/pizza/types");
    }
})
.to(serviceEndpointURI);
```

## How to throw the SOAP Fault from Camel

If you are using the camel-cxf endpoint to consume the SOAP request, you may need to throw the SOAP Fault from the camel context.

Basically, you can use the throwFault DSL to do that, it works for POJO, PAYLOAD and MESSAGE data format.

You can define the soap fault like this

```
SOAP_FAULT = new SoapFault(EXCEPTION_MESSAGE, SoapFault.FAULT_CODE_CLIENT);
Element detail = SOAP_FAULT.getOrCreateDetail();
Document doc = detail.getOwnerDocument();
Text tn = doc.createTextNode(DETAIL_TEXT);
detail.appendChild(tn);
```

Then throw it as you like

```
from(routerEndpointURI).throwFault(SOAP_FAULT);
```

If your cxf endpoint working in the MESSAGE data format, you could set the the SOAP Fault message into the message body and set the response code in the message header.

```
from(routerEndpointURI).process(new Processor() {

    public void process(Exchange exchange) throws Exception {
        Message out = exchange.getOut();
        // Set the message body with the
        out.setBody(this.getClass().getResourceAsStream("SoapFaultMessage.xml"));
        // Set the response code here
        out.setHeader(org.apache.cxf.message.Message.RESPONSE_CODE, new Integer(500));
    }

});
```

**NOTE** the response code setting only works in Camel's version >= 1.5.1

## How to propagate camel-cxf endpoint's request and response context

cxf client API provides a way to invoke the operation with request and response context. If you are using camel-cxf endpoint producer to invoke the outside web service, you can set the request context and get response context with below codes.

```
CxfExchange exchange = (CxfExchange)template.send(getJaxwsEndpointUri(), new
Processor() {
    public void process(final Exchange exchange) {
        final List<String> params = new ArrayList<String>();
        params.add(TEST_MESSAGE);
        // Set the request context to the inMessage
        Map<String, Object> requestContext = new HashMap<String, Object>();
        requestContext.put(BindingProvider.ENDPOINT_ADDRESS_PROPERTY,
JAXWS_SERVER_ADDRESS);
        exchange.getIn().setBody(params);
        exchange.getIn().setHeader(Client.REQUEST_CONTEXT , requestContext);
        exchange.getIn().setHeader(CxfConstants.OPERATION_NAME,
GREET_ME_OPERATION);
    }
});
org.apache.camel.Message out = exchange.getOut();
// The output is an object array, the first element of the array is the return
value
Object[] output = out.getBody(Object[].class);
LOG.info("Received output text: " + output[0]);
// Get the response context form outMessage
Map<String, Object> responseContext =
CastUtils.cast((Map)out.getHeader(Client.RESPONSE_CONTEXT));
assertNotNull(responseContext);
assertEquals("Get the wrong wsdl operation name", "{http://apache.org/
hello_world_soap_http}greetMe",
responseContext.get("javax.xml.ws.wsdl.operation").toString());
```

## See Also

- [Configuring Camel](#)
- [Component](#)
- [Endpoint](#)
- [Getting Started](#)

## DATASET COMPONENT

Testing of distributed and asynchronous processing is notoriously difficult. The Mock, Test and DataSet endpoints work great with the Camel Testing Framework to simplify your unit and integration testing using Enterprise Integration Patterns and Camel's large range of Components together with the powerful Bean Integration.

The DataSet component (available since 1.3.0) provides a mechanism to easily perform load & soak testing of your system. It works by allowing you to create DataSet instances both as a source of messages and as a way to assert that the data set is received.

Camel will use the throughput logger when sending dataset's.

### URI format

```
dataset:name?options
```

Where **name** is used to find the DataSet instance in the Registry

Camel ships with a support implementation of `org.apache.camel.component.dataset.DataSet`, the `org.apache.camel.component.dataset.DataSetSupport` class, that can be used as a base for implementing your own DataSet. Camel also ships with a default implementation, the `org.apache.camel.component.dataset.SimpleDataSet` that can be used for testing.

### Options

Option	Default	Description
<code>produceDelay</code>	-1	Allows a delay to be specified which causes producers to pause - to simulate slow producers
<code>consumeDelay</code>	-1	Allows a delay to be specified which causes consumers to pause - to simulate slow consumers
<code>preloadSize</code>	0	Sets how many messages should be preloaded (sent) before the route completes its initialization

## Configuring DataSet

Camel will lookup in the Registry for a bean implementing the DataSet interface. So you can register your own DataSet as:

```
<bean id="myDataSet" class="com.mycompany.MyDataSet">
  <property name="size" value="100"/>
</bean>
```

## Example

For example to test that a set of messages are sent to a queue then consumed from a queue without loosing any messages.

```
// send the dataset to a queue
from("dataset:foo").to("activemq:SomeQueue");

// now lets test that the messages are consumed correctly
from("activemq:SomeQueue").to("dataset:foo");
```

The above would look in the Registry to find the **foo** DataSet instance which is used to create the messages.

Then you create a DataSet implementation, such as using the SimpleDataSet as described below, configuring things like how big the data set is and what the messages look like etc.

## Properties on SimpleDataSet

Property	Type	Description
defaultBody	Object	Specifies the default message body. For SimpleDataSet it is a constant payload; though if you want to create custom payloads per message create your own derivation of DataSetSupport
reportGroup	long	Specifies the number of messages to be received before reporting progress. Useful for showing progress of a large load test
size	long	Specifies how many messages to send/consume

## Load testing ActiveMQ with Camel

There is an example of load testing an ActiveMQ queue using Camel in the ActiveMQ source code repository. The code lives at this location

- <https://svn.apache.org/repos/asf/activemq/trunk/activemq-camel-loadtest/>

You can grab the code

```
svn co https://svn.apache.org/repos/asf/activemq/trunk/activemq-camel-loadtest/
```

Then try running the test case

```
cd activemq-camel-loadtest
mvn clean install
```

To see how the test is defined see the Spring XML file

```
<beans xmlns="http://www.springframework.org/schema/beans"
       xmlns:xsi="http://www.w3.org/2001/XMLSchema-instance"
       xsi:schemaLocation="
         http://www.springframework.org/schema/beans http://www.springframework.org/
schema/beans/spring-beans-2.0.xsd
         http://activemq.apache.org/camel/schema/spring http://activemq.apache.org/camel/
schema/spring/camel-spring.xsd
         http://activemq.apache.org/schema/core http://activemq.apache.org/schema/core/
activemq-core.xsd
">

  <camelContext xmlns="http://activemq.apache.org/camel/schema/spring">

    <route>
      <!-- sends messages every 10 milliseconds -->
      <from uri="dataset:myDataSet?produceDelay=10" />
      <to uri="activemq:test.queue" />
    </route>

    <route>
      <from uri="activemq:test.queue" />
      <to uri="dataset:myDataSet?produceDelay=10" />
    </route>

  </camelContext>

  <bean id="myDataSet" class="org.apache.camel.component.dataset.SimpleDataSet">
    <property name="size" value="10000" />
    <property name="reportCount" value="100" />
  </bean>

  <!-- lets create an embedded broker for this test -->
  <broker xmlns="http://activemq.apache.org/schema/core" dataDirectory="target/
activemq">

    <transportConnectors>
      <transportConnector uri="tcp://localhost:61616" />
    </transportConnectors>

  </broker>

  <!-- Lets connect the Camel ActiveMQ component to the embedded broker.
  See http://activemq.apache.org/camel/activemq.html for more information.
  -->
  <bean id="activemq" class="org.apache.activemq.camel.component.ActiveMQComponent">
    <property name="brokerURL" value="tcp://localhost:61616" />
  </bean>
</beans>
```

## See Also

- [Configuring Camel](#)
- [Component](#)
- [Endpoint](#)
- [Getting Started](#)
- [Spring Testing](#)

## DIRECT COMPONENT

The **direct:** component provides direct, synchronous invocation of any consumers when a producer sends a message exchange.

This endpoint can be used to connect existing routes or if a client in the same JVM as the Camel router wants to access the routes.

### URI format

```
direct:someName
```

Where **someName** can be any string to uniquely identify the endpoint

### Options

Name	Default Value	Description
allowMultipleConsumers	true	If set to false, then when a second consumer is started on the endpoint, an <code>IllegalStateException</code> is thrown

### Samples

In the route below we use the direct component to link the two routes together:

```
from("activemq:queue:order.in").to("bean:orderServer?method=validate").to("direct:processOrder");  
from("direct:processOrder").to("bean:orderService?method=process").to("activemq:queue:order.out");
```

And the sample using spring DSL:

```
<route>  
  <from uri="activemq:queue:order.in"/>  
  <to uri="bean:orderService?method=validate"/>  
  <to uri="direct:processOrder"/>  
</route>  
  
<route>
```



## Asynchronous

The Seda component provides asynchronous invocation of any consumers when a producer sends a message exchange.

```
<from uri="direct:processOrder"/>
<to uri="bean:orderService?method=process"/>
<to uri="activemq:queue:order.out"/>
</route>
```

See also samples from the Seda component, how they can be used together.

## See Also

- [Configuring Camel](#)
- [Component](#)
- [Endpoint](#)
- [Getting Started](#)
- [Seda](#)

## ESPER

The Esper component supports the Esper Library for Event Stream Processing. The **camel-esper** library is provided by the Camel Extra project which hosts all \*GPL related components for Camel.

## URI format

```
esper:name[?option1=value[&option2=value2]]
```

When consuming from an Esper endpoint you must specify a **pattern** or **eql** statement to query the event stream.

For example

```
from("esper://cheese?pattern=every event=MyEvent(bar=5)").
to("activemq:Foo");
```

## Options

Name	Default Value	Description
pattern		The Esper Pattern expression as a String to filter events
eql		The Esper EQL expression as a String to filter events



## Demo

There is a demo which shows how to work with ActiveMQ, Camel and Esper in the Camel Extra project

## See Also

- [Configuring Camel](#)
- [Component](#)
- [Endpoint](#)
- [Getting Started](#)
- [Esper Camel Demo](#)

## EVENT COMPONENT

The **event**: component provides access to the Spring ApplicationEvent objects. This allows you to publish ApplicationEvent objects to a Spring ApplicationContext or to consume them. You can then use Enterprise Integration Patterns to process them such as Message Filter.

### URI format

```
event://default
```

As of Camel 1.5 the name has been renamed to `spring-event`

```
spring-event://default
```

## See Also

- [Configuring Camel](#)
- [Component](#)
- [Endpoint](#)
- [Getting Started](#)

## FILE COMPONENT

The File component provides access to file systems; allowing files to be processed by any other Camel Components or messages from other components can be saved to disk.

### URI format

```
file:fileOrDirectoryName[?options]
```

or

```
file://fileOrDirectoryName[?options]
```

Where **fileOrDirectoryName** represents the underlying file name. Camel will determine if **fileOrDirectoryName** is a file or directory.

## URI Options

Name	Default Value	Description
consumer.initialDelay	1000	Camel 1.4: milliseconds before polling the file/directory starts
consumer.delay	500	Camel 1.4: milliseconds before the next poll of the file/directory
consumer.useFixedDelay	false	Camel 1.4: <b>true</b> to use fixed delay between pools, otherwise fixed rate is used. See ScheduledExecutorService in JDK for details.
consumer.exclusiveReadLock	true	Camel 1.5: Used by FileConsumer. If set to <b>true</b> Camel will only poll the files if it has exclusive read lock to the file (= the file is not in progress of being written). Camel will wait until the file lock is granted. Setting to <b>false</b> Camel will poll the file even if its in progress of being written (= this is the behavior of Camel 1.4).
consumer.recursive	true/false	if a directory, will look for changes in files in all the sub directories. <b>Notice:</b> Default value in Camel 1.4 or older is <b>true</b> . In Camel 1.5 the default value is changed to <b>false</b> .
consumer.regexPattern	null	will only fire an exchange for a file that matches the regex pattern
consumer.alwaysConsume	false	Camel 1.5: <b>@deprecated</b> . Is used to force consuming the file even if it hasn't changed since last time it was consumed. Is useful if you for instance move files back into a folder and the file keeps the original timestamp.
consumer.timestamp	true	Camel 1.5: <b>@deprecated</b> . This option is introduced to have similar name as the same option in FTP component. Setting this option will internally in Camel set the <b>consumer.alwaysConsume</b> option to the <code>!value</code> . So if this option is true, then alwaysConsume is false and vice versa.
consumer.generateEmptyExchangeWhenIdle	false	<b>@deprecated</b> . Option only for the FileConsumer. If this option is <b>true</b> and there was no files to process we simulate processing a single empty file, so an exchange is fired. <b>Note:</b> In this situation the File attribute in FileExchange is null.
lock	true	if true will lock the file for the duration of the processing
delete	false	If delete is true then the file will be deleted when it is processed (the default is to move it, see below)
noop	false	If true then the file is not moved or deleted in any way (see below). This option is good for read only data, or for ETL type requirements.
moveNamePrefix	.camel/	The prefix String appended to the filename when moving it. For example to move processed files into the <i>done</i> directory, set this value to 'done'
moveNamePostfix	null	The postfix String appended to the filename when moving it. For example to rename processed files from <i>foo</i> to <i>foo.old</i> set this value to '.old'
append	true	When writing do we append to the end of the file, or replace it?
autoCreate	true	If set to true Camel will create the directory to the file if the file path does not exists - Uses <code>File#mkdirs()</code>
bufferSize	128kb	Write buffer sized in bytes. Camel uses a default of 128 * 1024 bytes.
ignoreFileNameHeader	false	<b>@deprecated</b> . If this flag is enabled then producers will ignore the 'org.apache.camel.file.name' header and generate a new dynamic filename
excludedNamePrefixes	null	<b>@deprecated</b> . Is used to exclude files if filename is starting with any of the given prefixes. The parameter is a <code>String[]</code>
excludedNamePostfixes	null	<b>@deprecated</b> . Is used to exclude files if filename is ending with any of the given prefixes. The parameter is a <code>String[]</code>
excludedNamePrefix	null	Camel 1.5: Is used to exclude files if filename is starting with the given prefix.
excludedNamePostfix	null	Camel 1.5: Is used to exclude files if filename is ending with the given postfix.
expression	null	Camel 1.5: Use expression to dynamically set the filename. This allows you to very easily set dynamic pattern style filenames. If an expression is set it take precedes over the <code>org.apache.camel.file.name</code> header. (Note: The header can itself also be an expression). The expression options supports both String and Expression types. If the expression is a String type then its <b>always</b> evaluated using the File Language. If the expression is an Expression type then this type is of course used as it - this allows for instance to use OGNL as expression too.
preMoveNamePrefix	null	Camel 1.5.1/2.0: The prefix String appended to the filename when moving it <b>before</b> processing. For example to move in progress files into the <i>inprogress</i> directory, set this value to 'inprogress'
preMoveNamePostfix	null	Camel 1.5.1/2.0: The postfix String appended to the filename when moving it <b>before</b> processing. For example to rename in progress files from <i>foo</i> to <i>foo.inprogress</i> set this value to '.inprogress'
preMoveExpression	null	Camel 1.5.1/2.0: Use expression to dynamically set the filename when moving it <b>before</b> processing. For example to move in progress file into the <i>order</i> directory and use <i>.bak</i> as extension set this value to 'order/\${file.name.noext}.bak'



## Camel 2.x

See File2 as the File component in Camel 2.x has been greatly enhanced, and has a lot of changes and new features.



## Important Information

See the section "Common gotchas with folder and filenames" below.



## Timestamp

In Camel 1.5 or older the file consumer uses an internal timestamp for last polling. This timestamp is used to match for new or changed files: if file modified timestamp > last poll timestamp => file can be consumed. Beware that its not persistent in any way so restarting Camel will restart the lastpolltime variable and you can potentially consume the same file again.

You can disable this algorithm with the new option **consumer.timestamp=false** or setting the **consumer.alwaysConsume=true**. Camel keeps track of consumed files which leads to a memory leak for large number of files in Camel 1.5.0 and older. This was replaced with a LRU cache in Camel 1.6.0.

**Notice:** This algorithm has been marked for @deprecation and has been removed in Camel 2.0. We **strongly** encourage you to use a different strategy for matching new files: such as deleting or moving the file after processing, then new files is always if there exists a file in the directory to poll.

## Default behavior for file consumer

- By default the file is locked for the duration of the processing.
- After the route has completed they are moved into the `.camel` subdirectory; so that they appear to be deleted.
- The File Consumer will always skip any file which name starts with a dot, such as `."`, `".camel"`, `".m2"` or `".groovy"`.
- Only files (not directories) is matched for valid filename if options such as: `consumer.regexPattern`, `excludeNamePrefix`, `excludeNamePostfix` is used. **Notice:** this only works properly in Camel 1.5.0, due to issue CAMEL-920.

## Default Behavior Changed in Camel 1.5.0

In Camel 1.5 the file consumer will avoid polling files that is currently in the progress of being written (see option **consumer.exclusiveReadLock**). However this requires Camel being able to rename the file for its testing. If the Camel user hasn't this rights on the file system, you can set this option to **false** to revert the change to the default behavior of Camel 1.4 or older.

The recursive option has changed its default value from true to false in Camel 1.5.0.

## Move and Delete operations

Any move or delete operations is executed after (post command) the routing has completed. So during processing of the Exchange the file is still located in the inbox folder.

Lets illustrate this with an example:

```
from("file://inbox?moveNamePrefix=done/").to("bean:handleOrder");
```

When a file is dropped in the inbox folder the file consumer notices this and creates a new `FileExchange` that is routed to the `handleOrder` bean. The bean then processes the File. At this point in time the File is still located in the inbox folder. After the bean completes and thus the route is completed the file consumer will perform the move operation and move the file to the done sub folder.

By default Camel will move consumed files to the sub folder `.camel` relative where the file was consumed.

### Available in Camel 1.5.1 or newer

We have introduced a **pre** move operation to move files **before** they are processed. This allows you to mark which files has been scanned as they are moved to this sub folder before being processed.

The following options support pre move:

- `preMoveNamePrefix`
- `preMoveNamePostfix`
- `preMoveExpression`

```
from("file://inbox?preMoveNamePrefix=inprogress/").to("bean:handleOrder");
```

You can combine the **pre** move and the regular move:

```
from("file://inbox?preMoveNamePrefix=inprogress/&moveNamePrefix=./done/").to("bean:handleOrder");
```

So in this situation the file is in the `inprogress` folder when being processed, and after it's processed it's moved to the `done` folder.

## Message Headers

The following message headers can be used to affect the behavior of the component

Header	Description
org.apache.camel.file.name	Specifies the output file name (relative to the endpoint directory) to be used for the output message when sending to the endpoint. If this is not present and no expression either then a generated message Id is used as filename instead.
org.apache.camel.file.name.produced	New in Camel 1.4: The actual absolute filepath (path + name) for the output file that was written. This header is set by Camel and its purpose is providing end-users the name of the file that was written.

### Common gotchas with folder and filenames

When Camel is producing files (writing files) there are a few gotchas how to set a filename of your choice. By default Camel will use the message id as the filename, and since the message id is normally a unique generated id you will end up with filenames such as: ID-MACHINENAME\2443-1211718892437\1-0. Such a filename is not desired and therefore best practice is to provide the filename in the message header "org.apache.camel.file.name".

The sample code below produces files using the message id as the filename:

```
from("direct:report").to("file:target/reports");
```

To use report.txt as the filename you have to do:

```
from("direct:report").setHeader(FileComponent.HEADER_FILE_NAME,
constant("report.txt")).to("file:target/reports");
```

Camel will default try to auto create the folder if it does not exists, and this is a bad combination with the UUID filename from above. So if you have:

```
from("direct:report").to("file:target/reports/report.txt");
```

And you want Camel to store in the file report.txt and autoCreate is true, then Camel will create the folder: target/reports/report.txt/. To fix this set the autoCreate=false and create the folder target/reports manually.

```
from("direct:report").to("file:target/reports/report.txt?autoCreate=false");
```

With auto create disabled Camel will store the report in the report.txt as expected.

### File consumer, scanning for new files gotcha

#### This only applies to Camel 1.x

The file consumer scans for new files by keeping an internal modified timestamp of the last consumed file. So if you copy a new file that has an older modified timestamp, then Camel will **not** pickup this file. This can happen if you are testing and you copy the same file back to the

folder that has just been consumed. To remedy this modify the timestamp before copying the file back.

## Filename Expression

In Camel 1.5 we have support for setting the filename using an expression. This can be set either using the **expression** option or as a string based File Language expression in the `org.apache.camel.file.name` header. See the File Language for some samples.

## Samples

### Read from a directory and write to another directory

```
from("file://inputdir/?delete=true").to("file://outputdir")
```

Listen on a directory and create a message for each file dropped there. Copy the contents to the outputdir and delete the file in the inputdir.

### Read from a directory and process the message in java

```
from("file://inputdir/").process(new Processor() {
    public void process(Exchange exchange) throws Exception {
        Object body = exchange.getIn().getBody();
        // do some business logic with the input body
    }
});
```

Body will be File object pointing to the file that was just dropped to the inputdir directory.

### Read files from a directory and send the content to a jms queue

```
from("file://inputdir/").convertBodyTo(String.class).to("jms:test.queue")
```

By default the file endpoint sends a FileMessage which contains a File as body. If you send this directly to the jms component the jms message will only contain the File object but not the content. By converting the File to a String the message will contain the file contents what is probably what you want to do.

The route above using Spring DSL:

```
<route>
  <from uri="file://inputdir/">
    <convertBodyTo type="java.lang.String"/>
    <to uri="jms:test.queue"/>
  </route>
```

## Writing to files

Camel is of course also able to write files, eg. producing files. In the sample below we receive some reports on the SEDA queue that we processes before they are written to a directory.

```
public void testToFile() throws Exception {
    MockEndpoint mock = getMockEndpoint("mock:result");
    mock.expectedMessageCount(1);
    mock.expectedFileExists("target/test-reports/report.txt");

    template.sendBody("seda:reports", "This is a great report");

    assertMockEndpointsSatisfied();
}

protected JndiRegistry createRegistry() throws Exception {
    // bind our processor in the registry with the given id
    JndiRegistry reg = super.createRegistry();
    reg.bind("processReport", new ProcessReport());
    return reg;
}

protected RouteBuilder createRouteBuilder() throws Exception {
    return new RouteBuilder() {
        public void configure() throws Exception {
            // the reports from the seda queue is processed by our processor
            // before they are written to files in the target/reports directory
            from("seda:reports").processRef("processReport").to("file://target/
test-reports", "mock:result");
        }
    };
}

private class ProcessReport implements Processor {

    public void process(Exchange exchange) throws Exception {
        String body = exchange.getIn().getBody(String.class);
        // do some business logic here

        // set the output to the file
        exchange.getOut().setBody(body);

        // set the output filename using java code logic, notice that this is done by
setting
        // a special header property of the out exchange
        exchange.getOut().setHeader(FileComponent.HEADER_FILE_NAME, "report.txt");
    }
}
```

## Using expression for filenames

In this sample we want to move consumed files to a backup folder using today's date as a sub foldername:

```
from("file://inbox?expression=backup/${date:now:yyyyMMdd}/${file:name}").to("...");
```

See File Language for more samples.

## Write to subdirectory using FileComponent.HEADER\_FILE\_NAME

Using a single route, it is possible to write a file to any number of subdirectories. If you have a route setup as such

```
<route>
  <from uri="bean:myBean"/>
  <to uri="file:/rootDirectory"/>
</route>
```

You can have myBean set the FileComponent.HEADER\_FILE\_NAME to values such as:

```
FileComponent.HEADER_FILE_NAME = hello.txt => /rootDirectory/hello.txt
FileComponent.HEADER_FILE_NAME = foo/bye.txt => /rootDirectory/foo/bye.txt
```

This allows you to have a single route to write files to multiple destinations.

## See Also

- [Configuring Camel](#)
- [Component](#)
- [Endpoint](#)
- [Getting Started](#)
- [File Language](#)
- [File2](#)

## FIX

The FIX component supports the FIX protocol by using the QuickFix/J library.

## URI format

```
fix://configurationResource
```

Where **configurationResource** points to the QuickFix/J configuration file to define how to connect to FIX. This could be a resource on the classpath or refer to a full URL using http: or file: schemes.



## Message Formats

By default this component will attempt to use the Type Converter to turn the inbound message body into a QuickFix Message class and all outputs from FIX will be in the same format.

If you are using the Artix Data Services support then any payload such as files or streams or byte arrays can be converted nicely into FIX messages.

## Using camel-fix

To use this module you need to use the FUSE Mediation Router distribution. Or you could just add the following to your pom.xml, substituting the version number for the latest & greatest release.

```
<dependency>
  <groupId>org.apache.camel</groupId>
  <artifactId>camel-parent</artifactId>
  <version>1.5.3.0-fuse</version>
</dependency>
```

And ensure you are pointing at the maven repo

```
<repository>
  <id>open.ionam2</id>
  <name>FUSESource Open Source Community Release Repository</name>
  <url>http://repo.fusesource.com/maven2/</url>
  <snapshots>
    <enabled>false</enabled>
  </snapshots>
  <releases>
    <enabled>true</enabled>
  </releases>
</repository>
```

## See Also

- [Configuring Camel](#)
- [Component](#)
- [Endpoint](#)
- [Getting Started](#)

## FLATPACK COMPONENT

The Flatpack component supports fixed width and delimited file parsing via the FlatPack library.

**Notice:** This component only supports consuming from flatpack files to Object model. You can not (yet) write from Object model to flatpack format.

## URI format

```
flatpack:[delim|fixed]:flatPackConfig.pzmap.xml
```

or for a delimited file handler with no configuration file just use

```
flatpack:someName
```

## Examples

- flatpack:fixed:foo.pzmap.xml creates a fixed width endpoint using the foo.pzmap.xml file configuration
- flatpack:delim:bar.pzmap.xml creates a delimited endpoint using the bar.pzmap.xml file configuration
- flatpack:foo creates a delimited endpoint called foo with no file configuration

## URI Options

Name	Default Value	Description
delimiter	'	The default character delimiter for delimited files
textQualifier	""	The text qualifier delimited files
ignoreFirstRecord	true	Whether the first line is ignored for delimited files (for the column headers)
splitRows	true	As of Camel 1.5 the component can either process each row one by one or the entire content at once.

## Message Headers

Camel will store the following headers on the IN message:

Header	Description
camelFlatpackCounter	The current row index. For splitRows=false the counter is the total number of rows.

## Message Body

The component delivers the data in the IN message as a `org.apache.camel.component.flatpack.DataSetList` object that have converters for `java.util.Map` or `java.util.List`.

Usually you want the Map if you process one row at a time (`splitRows=true`). And the List for

the entire content (`splitRows=false`), where each element in the list is a `Map`. Each `Map` contains the key for the column name and its corresponding value.

For example to get the first name from the sample below:

```
Map row = exchange.getIn().getBody(Map.class);
String firstName = row.get("FIRSTNAME");
```

However you can also always get it as a `List` (even for `splitRows=true`). The same example:

```
List data = exchange.getIn().getBody(List.class);
Map row = (Map)data.get(0);
String firstName = row.get("FIRSTNAME");
```

## Header and Trailer records

In Camel 1.5 onwards the header and trailer notions in Flatpack is supported. However it is required that you **must** use fixed record id names:

- `header` for the header record (must be lowercase)
- `trailer` for the trailer record (must be lowercase)

The example below illustrates this fact that we have a header and a trailer. You can omit one or both of them if not needed.

```
<RECORD id="header" startPosition="1" endPosition="3" indicator="HBT">
  <COLUMN name="INDICATOR" length="3"/>
  <COLUMN name="DATE" length="8"/>
</RECORD>

<COLUMN name="FIRSTNAME" length="35" />
<COLUMN name="LASTNAME" length="35" />
<COLUMN name="ADDRESS" length="100" />
<COLUMN name="CITY" length="100" />
<COLUMN name="STATE" length="2" />
<COLUMN name="ZIP" length="5" />

<RECORD id="trailer" startPosition="1" endPosition="3" indicator="FBT">
  <COLUMN name="INDICATOR" length="3"/>
  <COLUMN name="STATUS" length="7"/>
</RECORD>
```

## Using the endpoint

A common use case is sending a file to this endpoint for further processing in a separate route. For example...

```
<camelContext xmlns="http://activemq.apache.org/camel/schema/spring">
  <route>
    <from uri="file://someDirectory"/>
    <to uri="flatpack:foo"/>
  </route>

  <route>
```

```

<from uri="flatpack:foo"/>
...
</route>
</camelContext>

```

You can also convert the payload of each message created to a Map for easy Bean Integration

## FLATPACK DATAFORMAT

The Flatpack component ships with the Flatpack data format that can be used to format between fixed width or delimited text messages to a List of rows as Map.

- `marshal` = from `List<Map<String, Object>>` to `OutputStream` (can be converted to `String`)
- `unmarshal` = from `java.io.InputStream` (such as a `File`, `String`) to a `java.util.List` as an `org.apache.camel.component.flatpack.DataSetList` instance.

The result of the operation will contain all the data. If you need to process each row one by one you can split the exchange, using `Splitter`.

**Notice:** The Flatpack library does currently not support header and trailers for the marshal operation.

### Options

The data format has the following options:

Option	Default	Description
<code>definition</code>	<code>null</code>	The flatpack pzmap configuration file. Can be omitted in simpler situations, but its preferred to use the pzmap.
<code>fixed</code>	<code>false</code>	Delimited or fixed
<code>ignoreFirstRecord</code>	<code>true</code>	Whether the first line is ignored for delimited files (for the column headers)
<code>textQualifier</code>	<code>"</code>	if the text is qualified with a char such as <code>"</code>
<code>delimiter</code>	<code>,</code>	the delimiter char ( <code>;</code> , <code>,</code> or the likes)
<code>parserFactory</code>	<code>null</code>	Uses the default Flatpack parser factory

### Usage

To use the data format simply instantiate an instance and invoke the `marshal` or `unmarshal` operation in the route builder:

```

FlatpackDataFormat fp = new FlatpackDataFormat();
fp.setDefinition(new ClassPathResource("INVENTORY-Delimited.pzmap.xml"));

```

```
...
from("file:order/in").unmarshal(df).to("seda:queue:neworder");
```

The sample above will read files from the order/in folder and unmarshal the input using the Flatpack configuration file `INVENTORY-Delimited.pzmap.xml` that configures the structure of the files. The result is a `DataSetList` object we store on the seda queue.

```
FlatpackDataFormat df = new FlatpackDataFormat();
df.setDefinition(new ClassPathResource("PEOPLE-FixedLength.pzmap.xml"));
df.setFixed(true);
df.setIgnoreFirstRecord(false);

from("seda:people").marshal(df).convertBodyTo(String.class).to("jms:queue:people");
```

In the code above we marshal the data from a `Object` representation as a `List` of rows as `Maps`. The rows as `Map` contains the column name as the key, and the the corresponding value. This structure can be created in Java code from e.g. a processor. We marshal the data according to the Flatpack format and converts the result as a `String` object and store it on a `jms` queue.

## Dependencies

To use Flatpack in your camel routes you need to add the a dependency on **camel-flatpack** which implements this data format.

If you use maven you could just add the following to your `pom.xml`, substituting the version number for the latest & greatest release (see the download page for the latest versions).

```
<dependency>
  <groupId>org.apache.camel</groupId>
  <artifactId>camel-flatpack</artifactId>
  <version>1.5.0</version>
</dependency>
```

## See Also

- [Configuring Camel](#)
- [Component](#)
- [Endpoint](#)
- [Getting Started](#)

## FTP/SFTP COMPONENT

This component provides access to remote file systems over the FTP and SFTP protocols.

### URI format

```
ftp://[username@]hostname[:port]/filename[?options]
sftp://[username@]hostname[:port]/filename[?options]
```

Where **filename** represents the underlying file name or directory. Can contain nested folders. The **username** is currently only possible to provide in the hostname parameter.

If no **username** is provided then anonymous login is attempted using no password.

If no **port** number is provided. Camel will provide default values according to the protocol. (ftp = 21, sftp = 22)

## Examples

```
ftp://someone@someftpserver.com/public/upload/images/
holiday2008?password=secret&binary=true
ftp://someoneelse@someotherftpserver.co.uk:12049/reports/2008/
budget.txt?password=secret&binary=false&directory=false
ftp://publicftpserver.com/download
```

## URI Options

Name	Default Value	Description
directory	true	indicates whether or not the given file name should be interpreted by default as a directory or file (as it sometimes hard to be sure with some FTP servers)
password	null	specifies the password to use to login to the remote file system
binary	false	specifies the file transfer mode BINARY or ASCII. Default is ASCII.
ftpClientConfig	null	Camel 1.5: Reference to a bean in the registry as a <code>org.apache.commons.net.ftp.FTPClientConfig</code> class. Use this option if you need to configure the client according to the FTP Server date format, locale, timezone, platform etc. See the javadoc <code>FTPClientConfig</code> for more documentation.
consumer.recursive	true/false	if a directory, will look for changes in files in all the sub directories. Is <b>true</b> as default for Camel 1.4 or older. Will change to <b>false</b> as default value as of Camel 1.5
consumer.setNames	true	<b>@deprecated</b> Used by FTPConsumer. If true Camel will use the filename the file has on the FTP server. The filename is stored on the IN message in the header <code>FileComponent.HEADER_FILE_NAME</code> . <b>Note:</b> In Camel 1.4 the default value has changed to <b>true</b> .
consumer.delay	500	Delay in millis between each poll
consumer.initialDelay	1000	Millis before polling starts
consumer.userFixedDelay	false	<b>true</b> to use fixed delay between pools, otherwise fixed rate is used. See <code>ScheduledExecutorService</code> in JDK for details.
consumer.regexPattern	null	Used by FTPConsumer. Regular expression to use for matching files when consuming.
consumer.exclusiveReadLock	false	Camel 1.5: Used by FTPConsumer. If set to true Camel will only poll the ftp files if it has exclusive read to the file (= the file is not in progress of being written). Camel will wait until it is granted, testing once every second. The test is implemented by Camel will try to rename the file. Setting to false Camel will poll the file even if its in progress of being written.
consumer.deleteFile	false	Camel 1.5: Used by FTPConsumer. Flag to set if the consumed file should be deleted after it has been downloaded.
consumer.moveNamePrefix	null	Camel 1.5: Used by FTPConsumer. The prefix String appended to the filename when moving it. For example to move processed files into the done directory, set this value to 'done'
consumer.moveNamePostfix	null	Camel 1.5: Used by FTPConsumer. The postfix String appended to the filename when moving it. For example to rename processed files from <code>foo</code> to <code>foo.old</code> set this value to '.old'
consumer.excludedNamePrefix	null	Camel 1.5: Used by FTPConsumer. Is used to exclude files if filename is starting with the given prefix.
consumer.excludedNamePostfix	null	Camel 1.5: Used by FTPConsumer. Is used to exclude files if filename is ending with the given postfix.
consumer.timestamp	false	Camel 1.5: <b>@deprecated</b> will be removed in Camel 2.0. This option is only for backwards comparability.
expression	null	Camel 1.5: Use expression to dynamically set the filename. This allows you to very easily set dynamic pattern style filenames. If an expression is set it take precedes over the <code>org.apache.camel.file.name</code> header. (Note: The header can itself also be an expression). The expression options supports both String and Expression types. If the expression is a String type then its <b>always</b> evaluated using the File Language. If the expression is an Expression type then this type is of course used as it - this allows for instance to use OGNL as expression too.
passiveMode	false	Camel 1.5.1/2.0: Set whether to use passive mode connections. Default is active. This feature is only for regular FTP, not SFTP.



## Camel 2.x

See FTP2 as the File component in Camel 2.x has been greatly enhanced, and has a lot of changes and new features.



## Timestamp

In Camel 1.4 or older the FTP consumer uses an internal timestamp for last polling. This timestamp is used to match for new remote files: if remote file modified timestamp > last poll timestamp => file can be consumed.

In Camel 1.5 this algorithm has been disabled by default as its not reliable over the FTP protocol. FTP Servers only return file modified timestamps using HH:mm (not seconds). And of course the clocks between the client and server can also be out of sync. Bottom line is that timestamp check for FTP protocol should **not** be used. That is why this feature is marked as **@deprecated** and will be removed in Camel 2.0.

We encourage you to use a different strategy for matching new remote files: such as deleting or moving the file after download.



## More examples

This component is an extension of the File component. So there could be more samples and details on the File component page as well.

knownHosts	null	Camel 1.5.1/2.0: Sets the known_hosts file so that the SFTP endpoint can do host key verification.
privateKeyFile	null	Camel 1.5.1/2.0: Set the private key file to that the SFTP endpoint can do private key verification.
privateKeyFilePassphrase	null	Camel 1.5.1/2.0: Set the private key file passphrase to that the SFTP endpoint can do private key verification.

## New default behavior for FTP/SFTP-Consumers in Camel 1.5

The consumer will always skip any file which name starts with a dot, such as ". ", ".camel", ".m2" or ".groovy". Only files (not directories) is matched for valid filename if options such as: `consumer.regexPattern`, `consumer.excludeNamePrefix`, `consumer.excludeNamePostfix` is used.

The consumer recursive option will be changed from **true** to **false** as the default value. We don't feel that Camel out-of-the-box should recursive poll.

The consumer will **not** use timestamp algorithm for determine if a remote file is a new file - see warning section above. To use the old behavior of Camel 1.4 or older you can use the option `consumer.timestamp=true`.

### Exclusive Read Lock

The option **readLock** can be used to force Camel **not** to consume files that is currently in the progress of being written. However this option is default turned off, as it requires that the user has write access. There are other solutions to avoid consuming files that are currently being written over FTP, for instance you can write the a temporary destination and move the file after it has been written.

### Message Headers

The following message headers can be used to affect the behavior of the component

Header	Description
<code>org.apache.camel.file.name</code>	Specifies the output file name (relative to the endpoint directory) to be used for the output message when sending to the endpoint. If this is not present and no expression either then a generated message Id is used as filename instead.
<code>org.apache.camel.file.name.produced</code>	New in Camel 1.5: The actual absolute filepath (path + name) for the output file that was written. This header is set by Camel and its purpose is providing end-users the name of the file that was written.
<code>org.apache.camel.file.total</code>	Camel 2.0: Current index out of total number of files being consumed in this batch.
<code>org.apache.camel.file.index</code>	Camel 2.0: Total number of files being consumed in this batch.
<code>file.remote.host</code>	The hostname of the remote server
<code>file.remote.name</code>	The name of the file consumed from the remote server
<code>file.remote.fullName</code>	The fullname of the file consumed from the remote server

### Consumer properties

When using FTPConsumer (downloading files from a FTP Server) the consumer specific properties from the File component should be prefixed with "consumer.". For example the



delay option from File Component should be specified as "consumer.delay=30000" in the URI. See the samples or some of the unit tests of this component.

## Filename Expression

In Camel 1.5 we have support for setting the filename using an expression. This can be set either using the **expression** option or as a string based File Language expression in the `org.apache.camel.file.name` header. See the File Language for some samples.

## Camel 1.x Known issues

See the timestamp warning.

When consuming files (downloading) you must use type conversation to either String or to InputStream for ASCII and BINARY file types.

In Camel 1.4 this is fixed, as there are build in type converters for the ASCII and BINARY file types, meaning that you do not need the `convertBodyTo` expression.

In Camel 1.4 or below Camel FTPConsumer will poll files regardless if the file is currently being written. See the **consumer.exclusiveReadLock** option.

Also in Camel 1.3 since `setName` is default **false** then you must explicitly set the filename using the `setHeader` expression when consuming from FTP directly to File.

The code below illustrates this:

```
private String ftpUrl =
"ftp://camelrider@localhost:21/public/downloads?password=admin&binary=false";
private String fileUrl = "file:myfolder/?append=false&noop=true";

return new RouteBuilder() {
    public void configure() throws Exception {
        from(ftpUrl).setHeader(FileComponent.HEADER_FILE_NAME,
constant("downloaded.txt")).convertBodyTo(String.class).to(fileUrl);
    }
};
```

Or you can set the option to **true** as illustrated below:

```
private String ftpUrl =
"ftp://camelrider@localhost:21/public/downloads?password=admin&binary=false&consumer.setName=true";
private String fileUrl = "file:myfolder/?append=false&noop=true";

return new RouteBuilder() {
    public void configure() throws Exception {
        from(ftpUrl).convertBodyTo(String.class).to(fileUrl);
    }
};
```

## Sample

In the sample below we setup Camel to download all the reports from the FTP server once every hour (60 min) as BINARY content and store it as files on the local file system.

```
protected RouteBuilder createRouteBuilder() throws Exception {
    return new RouteBuilder() {
        public void configure() throws Exception {
            // we use a delay of 60 minutes (eg. once pr. hour we poll the FTP server
            long delay = 60 * 60 * 1000L;

            // from the given FTP server we poll (= download) all the files
            // from the public/reports folder as BINARY types and store this as files
            // in a local directory. Camel will use the filenames from the FTPServer

            // notice that the FTPConsumer properties must be prefixed with
            "consumer." in the URL
            // the delay parameter is from the FileConsumer component so we should use
            consumer.delay as
            // the URI parameter name. The FTP Component is an extension of the File
            Component.

            from("ftp://scott@localhost/public/reports?password=tiger&binary=true&consumer.delay="
            + delay).
                to("file://target/test-reports");
        }
    };
}
```

And the route using Spring DSL:

```
<route>
  <from uri="ftp://scott@localhost/public/
reports?password=tiger&binary=true&consumer.delay=60000"/>
  <to uri="file://target/test-reports"/>
</route>
```

## Using expression for filenames

In this sample we want to move consumed files to a backup folder using today's date as a sub foldername. Notice that the move happens on the remote FTP server. If you want to store the downloaded file on your local disk then route it to the File component as the sample above illustrates.

```
from(ftpUrl + "&expression=backup/${date:now:yyyyMMdd}/${file:name}") .to("...");
```

See File Language for more samples.

## Consuming a remote FTP server triggered by a route

The FTP consumer is build as a scheduled consumer to be used in the **from** route. However if you want to start consuming from a FTP server triggered within a route it's a bit cumbersome to do this in Camel 1.x (we plan to improve this in Camel 2.x). However it's possible as this code below demonstrates.

In the sample we have a Seda queue where a message arrives that holds a message containing a filename to poll from a remote FTP server. So we setup a basic FTP url as:

```
// we use directory=false to indicate we only want to consume a single file
// we use delay=5000 to use 5 sec delay between pools to avoid polling a second time
before we stop the consumer
// this is because we only want to run a single poll and get the file
// file=getme/ is the path to the folder where the file is
private String getFtpUrl() {
    return "ftp://admin@localhost:" + getPort() +
    "?password=admin&binary=false&directory=false&consumer.delay=5000&file=getme/";
}
```

And then we have the route where we use Processor within the route so we can use Java code. In this Java code we create the ftp consumer that downloads the file we want. And after the download we can get the content of the file and put it in the original exchange that continues being routed. As this is based on an unit test it routes to a Mock endpoint.

```
from("seda:start").process(new Processor() {
    public void process(final Exchange exchange) throws Exception {
        // get the filename from our custome header we want to get from a remote server
        String filename = exchange.getIn().getHeader("myfile", String.class);

        // construct the total url for the ftp consumer
        String url = getFtpUrl() + filename;

        // create a ftp endpoint
        Endpoint ftp = context.getEndpoint(url);

        // create a polling consumer where we can poll the myfile from the ftp server
        PollingConsumer consumer = ftp.createPollingConsumer();

        // must start the consumer before we can receive
        consumer.start();

        // poll the file from the ftp server
        Exchange result = consumer.receive();

        // the result is the response from the FTP consumer (the downloaded file)
        // replace the outhter exchange with the content from the downloaded file
        exchange.getIn().setBody(result.getIn().getBody());

        // stop the consumer
        consumer.stop();
    }
}).to("mock:result");
```

## Debug logging

This component has log level **TRACE** that can be helpful if you have problems.

## See Also

- [Configuring Camel](#)
- [Component](#)
- [Endpoint](#)
- [Getting Started](#)

## HIBERNATE COMPONENT

The **hibernate** component allows you to work with databases using Hibernate as the object relational mapping technology to map POJOs to database tables. The **camel-hibernate** library is provided by the Camel Extra project which hosts all \*GPL related components for Camel.

### Sending to the endpoint

Sending POJOs to the hibernate endpoint inserts entities into the database. The body of the message is assumed to be an entity bean that you have mapped to a relational table using the hibernate .hbm.xml files.

If the body does not contain an entity bean then use a Message Translator in front of the endpoint to perform the necessary conversion first.

### Consuming from the endpoint

Consuming messages removes (or updates) entities in the database. This allows you to use a database table as a logical queue, consumers take messages from the queue and then delete/update them to logically remove them from the queue.

If you do not wish to delete the entity when it has been processed you can specify **consumeDelete=false** on the URI. This will result in the entity being processed each poll.

If you would rather perform some update on the entity to mark it as processed (such as to exclude it from a future query) then you can annotate a method with `@Consumed` which will be invoked on your entity bean when the entity bean is consumed.

### URI format

```
hibernate:[entityClassName]
```

For sending to the endpoint, the **entityClassName** is optional. If specified it is used to help use the [Type Conversion] to ensure the body is of the correct type.

For consuming the **entityClassName** is mandatory.

## Options

Name	Default Value	Description
entityType	entityClassName	Is the provided entityClassName from the URI
consumeDelete	true	Option for HibernateConsumer only. Enables / disables whether or not the entity is deleted after it is consumed.
consumeLockEntity	true	Option for HibernateConsumer only. Enables / disables whether or not to use exclusive locking of each entity while processing the results from the pooling.
flushOnSend	true	Option for HibernateProducer only. Flushes the EntityManager after the entity beans has been persisted.
maximumResults	-1	Option for HibernateConsumer only. Set the maximum number of results to retrieve on the Query.
consumer.delay	500	Option for HibernateConsumer only. Delay in millis between each poll.
consumer.initialDelay	1000	Option for HibernateConsumer only. Millis before polling starts.
consumer.userFixedDelay	false	Option for HibernateConsumer only. <b>true</b> to use fixed delay between pools, otherwise fixed rate is used. See ScheduledExecutorService in JDK for details.

## See Also

- Configuring Camel
- Component
- Endpoint
- Getting Started

## HL7 COMPONENT

The **hl7** component is used for working with the HL7 MLLP protocol and the HL7 model using the HAPI library.

This component supports the following:

- HL7 MLLP codec for Mina
- Agnostic data format using either plain String objects or HAPI HL7 model objects.
- Type Converter from/to HAPI and String
- HL7 DataFormat using HAPI library
- Even more easy-of-use as its integrated well with the camel-mina component.

### HL7 MLLP protocol

HL7 is often used with the HL7 MLLP protocol that is a text based TCP socket based protocol. This component ships with a Mina Codec that conforms to the MLLP protocol so you can easily expose a HL7 listener that accepts HL7 requests over the TCP transport.

To expose a HL7 listener service we reuse the existing camel-mina component where we just use the HL7MLLPCodec as codec.

The HL7 MLLP codec has the following options:

Name	Default Value	Description
startByte	0x0b	The start byte spanning the HL7 payload. Is the HL7 default value of 0x0b (11 decimal)
endByte1	0x1c	The first end byte spanning the HL7 payload. Is the HL7 default value of 0x1c (28 decimal)
endByte2	0x0d	The 2nd end byte spanning the HL7 payload. Is the HL7 default value of 0x0d (13 decimal)
charset	JVM Default	The encoding (is a charset name) to use for the codec. If not provided Camel will use the JVM default Charset.
convertLFtoCR	true	Will convert \n to \r (0x0d, 13 decimal) as HL7 usually uses \r as segment terminators. The HAPI library requires to use \r.

### Exposing a HL7 listener

In our spring xml file we configure an endpoint to listen for HL7 requests using TCP:

```
<endpoint id="hl7listener"
uri="mina:tcp://localhost:8888?sync=true&codec=hl7codec"/>
```

Notice we configure it to use camel-mina with TCP on the localhost on port 8888. We use the **sync=true** to indicate that this listener is synchronous and therefore will return a HL7

response to the caller. Then we setup mina to use our HL7 codec with **codec=hl7codec**. Notice that hl7codec is just a spring bean id, so we could have named it mygreatcodecforhl7 or whatever. The codec is also setup in the spring xml file:

```
<bean id="hl7codec" class="org.apache.camel.component.hl7.HL7MLLPCodec">
    <property name="charset" value="iso-8859-1"/>
</bean>
```

And here we configure the charset encoding to use, and iso-8859-1 is commonly used.

The endpoint **hl7listener** can then be used in a route as a consumer, as this java DSL example illustrates:

```
from("hl7socket").to("patientLookupService");
```

This is a very simple route that will listen for HL7 and route it to a service named **patientLookupService** that is also a spring bean id we have configured in the spring xml as:

```
<bean id="patientLookupService"
class="com.mycompany.healthcare.service.PatientLookupService"/>
```

And another powerful feature of Camel is that we can have our business logic in POJO classes that is not at all tied to Camel as shown here:

```
public class PatientLookupService {
    public Message lookupPatient(Message input) throws HL7Exception {
        QRD qrd = (QRD)input.get("QRD");
        String patientId = qrd.getWhoSubjectFilter(0).getIDNumber().getValue();

        // find patient data based on the patient id and create a HL7 model object
with the response
        Message response = ... create and set response data
        return response
    }
}
```

Notice that this class is just using imports from the HAPI library and **none** from Camel.

## HL7 Model using java.lang.String

The HL7MLLP codec uses plain String as data format. And Camel uses Type Converter to convert from/to Strings to the HAPI HL7 model objects. However you can use the plain String objects if you would like to, for instance if you need to parse the data yourself.

See samples for such an example.

## HL7 Model using HAPI

The HL7 model is Java objects from the HAPI library. Using this library we can encode and decode from the EDI format (ER7) that is mostly used with HL7.

With this model you can code with Java objects instead of the EDI based HL7 format that can be hard for humans to read and understand.

The ER7 sample below is a request to lookup a patient with the patient id 0101701234.

```
MSH|^~\&|MYSENDER|MYRECEIVER|MYAPPLICATION||200612211200||QRY^A19|1234|P|2.4
QRD|200612211200|R|I|GetPatient||1^RD|0101701234|DEM||
```

Using the HL7 model we can work with the data as a `ca.uhn.hl7v2.model.Message.Message` object.

To retrieve the patient id for the patient in the ER7 above you can do this in java code:

```
Message msg = exchange.getIn().getBody(Message.class);
QRD qrd = (QRD)msg.get("QRD");
String patientId = qrd.getWhoSubjectFilter(0).getIDNumber().getValue();
```

Camel has build in type converters so when this operation is invoked:

```
Message msg = exchange.getIn().getBody(Message.class);
```

Camel will converter the received HL7 data from String to the Message object. This is powerful when combined with the HL7 listener, then you as the end-user don't have to work with byte[], String or any other simple object formats. You can just use the HAPI HL7 model objects.

## HL7 DATAFORMAT

The HL7 component ships with a HL7 dataformat that can be used to format between String and HL7 model objects.

- `marshal` = from Message to byte stream (can be used when returning as response using the HL7 MLLP codec)
- `unmarshal` = from byte stream to Message (can be used when receiving streamed data from the HL7 MLLP)

To use the data format simply instantiate an instance and invoke the marshal or unmarshal operation in the route builder:

```
DataFormat hl7 = new HL7DataFormat();
...
from("direct:hl7in").marshal(hl7).to("jms:queue:hl7out");
```

In the sample above the HL7 is marshalled from a HAPI Message object to a byte stream and put on a JMS queue.

The next example is the opposite:

```
DataFormat hl7 = new HL7DataFormat();
...
from("jms:queue:hl7out").unmarshal(hl7).to("patientLookupService");
```

Here we unmarshal the byte stream into a HAPI Message object that is passed to our patient lookup service.

Notice there is a shorthand syntax in Camel for well known data formats that is commonly used.

Then you don't need to create an instance of the HL7DataFormat object:

```
from("direct:hl7in").marshal().hl7().to("jms:queue:hl7out");
from("jms:queue:hl7out").unmarshal().hl7().to("patientLookupService");
```



The **unmarshal** operation adds these MSH fields as headers on the Camel message:

Key	MSH field	Example
hl7.msh.sendingApplication	MSH-3	MYSERVER
hl7.msh.sendingFacility	MSH-4	MYSERVERAPP
hl7.msh.receivingApplication	MSH-5	MYCLIENT
hl7.msh.receivingFacility	MSH-6	MYCLIENTAPP
hl7.msh.timestamp	MSH-7	20071231235900
hl7.msh.security	MSH-8	null
hl7.msh.messageType	MSH-9-1	ADT
hl7.msh.triggerEvent	MSH-9-2	A01
hl7.msh.messageControl	MSH-10	1234
hl7.msh.processingId	MSH-11	P
hl7.msh.versionId	MSH-12	2.4

All headers are String types. If a header value is missing its value is `null`.

## Dependencies

To use HL7 in your camel routes you need to add the a dependency on **camel-hl7** which implements this data format.

If you use maven you could just add the following to your pom.xml, substituting the version number for the latest & greatest release (see the download page for the latest versions).

```
<dependency>
  <groupId>org.apache.camel</groupId>
  <artifactId>camel-hl7</artifactId>
  <version>1.5.0</version>
</dependency>
```

## SAMPLES

In the following example we send a HL7 request to a HL7 listener and retrieves a response. We use plain String types in this example:

```
String line1 =
"MSH|^~\&|MYSENDER|MYRECEIVER|MYAPPLICATION||200612211200||QRY^A19|1234|P|2.4";
String line2 = "QRD|200612211200|R|I|GetPatient|||I^RD|0101701234|DEM||";

StringBuffer in = new StringBuffer();
in.append(line1);
in.append("\n");
```

```

in.append(line2);

String out =
(String)template.requestBody("mina:tcp://localhost:8888?sync=true&codec=hl7codec",
in.toString());

```

In the next sample we want to route HL7 requests from our HL7 listener to our business logic. We have our business logic in a plain POJO that we have registered in the registry as `hl7service` = for instance using Spring and letting the bean id = `hl7service`.

Our business logic is a plain POJO only using the HAPI library so we have these operations defined:

```

public class MyHL7BusinessLogic {

    // This is a plain POJO that has NO imports whatsoever on Apache Camel.
    // its a plain POJO only importing the HAPI library so we can much easier work
    with the HL7 format.

    public Message handleA19(Message msg) throws Exception {
        // here you can have your business logic for A19 messages
        assertTrue(msg instanceof QRY_A19);
        // just return the same dummy response
        return createADR19Message();
    }

    public Message handleA01(Message msg) throws Exception {
        // here you can have your business logic for A01 messages
        assertTrue(msg instanceof ADT_A01);
        // just return the same dummy response
        return createADT01Message();
    }
}

```

Then we setup the Camel routes using the RouteBuilder as:

```

DataFormat hl7 = new HL7DataFormat();
// we setup or HL7 listener on port 8888 (using the hl7codec) and in sync mode so we
can return a response
from("mina:tcp://localhost:8888?sync=true&codec=hl7codec")
    // we use the HL7 data format to unmarshal from HL7 stream to the HAPI Message
    model
    // this ensures that the camel message has been enriched with hl7 specific headers
    to
    // make the routing much easier (see below)
    .unmarshal(hl7)
    // using choice as the content base router
    .choice()
    // where we choose that A19 queries invoke the handleA19 method on our
    hl7service bean
    .when(header("hl7.msh.triggerEvent").isEqualTo("A19"))
        .beanRef("hl7service", "handleA19")
        .to("mock:a19")
    // and A01 should invoke the handleA01 method on our hl7service bean
    .when(header("hl7.msh.triggerEvent").isEqualTo("A01")).to("mock:a01")
        .beanRef("hl7service", "handleA01")

```

```

        .to("mock:a19")
        // other types should go to mock:unknown
        .otherwise()
            .to("mock:unknown")
        // end choice block
    .end()
    // marshal response back
    .marshal(hl7);

```

Notice that we use the HL7 DataFormat to enrich our Camel Message with the MSH fields preconfigured on the Camel Message. This let us much more easily define our routes using the fluent builders.

If we do not use the HL7 DataFormat then we do not gains these headers and we must resort to a different technique for computing the MSH trigger event (= what kind of HL7 message it is). This is a big advantage of the HL7 DataFormat over the plain HL7 type converters.

### Sample using plain String objects

In this sample we use plain String objects as the data format, that we send, process and receive. As the sample is part of an unit test there is some code for assertions, but you should be able to understand what happens. First we send the plain String Hello World to the HL7MLLPCodec and receives the response that is also just plain string as we receive Bye World.

```

MockEndpoint mock = getMockEndpoint("mock:result");
mock.expectedBodiesReceived("Bye World");

// send plain hello world as String
Object out =
template.requestBody("mina:tcp://localhost:8888?sync=true&codec=hl7codec", "Hello
World");

assertMockEndpointsSatisfied();

// and the response is also just plain String
assertEquals("Bye World", out);

```

Here we process the incoming data as plain String and send the response also as plain String:

```

from("mina:tcp://localhost:8888?sync=true&codec=hl7codec")
    .process(new Processor() {
        public void process(Exchange exchange) throws Exception {
            // use plain String as message format
            String body = exchange.getIn().getBody(String.class);
            assertEquals("Hello World", body);

            // return the response as plain string
            exchange.getOut().setBody("Bye World");
        }
    })
    .to("mock:result");

```

## See Also

- [Configuring Camel](#)
- [Component](#)
- [Endpoint](#)
- [Getting Started](#)

## HTTP COMPONENT

The **http:** component provides HTTP based endpoints for consuming external HTTP resources (as a client to call external servers using HTTP).

### URI format

```
http:hostname[:port][/resourceUri][?options]
```

Will default use port 80 for http and 443 for https.

### Options

Name	Default Value	Description
httpClient.XXX	null	Setting options on the HttpClientParams. For instance httpClient.setTimeout(5000) will set the SO_TIMEOUT to 5 seconds.

### Message Headers

Name	Type	Description
HttpProducer.QUERY	String	URI parameters. Will override existing URI parameters set directly on the endpoint. Is set on the IN message.
HttpProducer.HTTP_URI	String	<b>Camel 1.5.1:</b> URI to call. Will override existing URI set directly on the endpoint. Is set on the IN message.
HttpProducer.HTTP_RESPONSE_CODE	int	The http response code from the external server. Is 200 for OK. Is set on the OUT message.



## camel-http vs camel-jetty

You can only produce to endpoints generated by the HTTP component. Therefore it should never be used as input into your camel Routes. To bind/expose an HTTP endpoint via a http server as input to a camel route, you can use the Jetty Component

### Message Body

Camel will store the http response from the external server on the OUT body. All headers from the IN message will be copied to the OUT message so headers is preserved during routing.

Additionally Camel will add the http response headers as well to the OUT message.

### Response code

Camel will handle according to the http response code:

- response code is between 100..299 then Camel regard it as a success response
- response code is between 300..399 then Camel regard it as a redirection was returned and will throw a `HttpOperationFailedException` with the information
- response code is 400+ then Camel regard it as a external server failure and will throw a `HttpOperationFailedException` with the information

### HttpOperationFailedException

This exception contains the following information

- the http status code
- the http status line (text of the status code)
- redirect location if server returned a redirect
- responseBody as a `java.io.InputStream` if server provided a body as response

### Calling using GET or POST

In **Camel 1.5** the following algorithm is used to determine if either GET or POST http method should be used:

1. Use method provided in header
2. GET is query string is provided in header
3. GET if endpoint is configured with a query string
4. POST if there is data to send (body is not null)
5. GET otherwise

## Configuring URI to call

You can set the http producer's URI directly form the endpoint URI. In the route below Camel will call our to the external server oldhost using HTTP.

```
from("direct:start")
    .to("http://oldhost");
```

And the equivalent spring sample:

```
<camelContext xmlns="http://activemq.apache.org/camel/schema/spring">
  <route>
    <from uri="direct:start"/>
    <to uri="http://oldhost"/>
  </route>
</camelContext>
```

In **Camel 1.5.1** you can override the http endpoint URI by adding a header with the key `HttpProducer.HTTP_URI` on the message.

```
from("direct:start")
    .setHeader(org.apache.camel.component.http.HttpProducer.HTTP_URI,
constant("http://newhost"))
    .to("http://oldhost");
```

In the sample above Camel will call the `http://newhost` despite the endpoint is configured with `http://oldhost`.

## Configuring URI Parameters

The **http** producer supports URI parameters to be sent to the HTTP server. The URI parameters can either be set directly on the endpoint URI or as a header with the key `HttpProducer.QUERY` on the message.

```
from("direct:start")
    .to("http://oldhost?order=123&detail=short");
```

Or options provided in a header:

```
from("direct:start")
    .setHeader(org.apache.camel.component.http.HttpProducer.HTTP_QUERY,
constant("order=123&detail=short"))
    .to("http://oldhost");
```

## How to set the http method (GET/POST/PUT/DELETE/HEAD/OPTIONS/TRACE) to the HTTP producer

The HTTP component provides a way to set the HTTP request method by setting the message header. Here is an example;

```
from("direct:start")
    .setHeader(org.apache.camel.component.http.HttpMethods.HTTP_METHOD,
constant(org.apache.camel.component.http.HttpMethods.POST))
```

```
.to("http://www.google.com")
.to("mock:results");
```

The method can be written a bit shorter using the string constant:

```
.setHeader(org.apache.camel.component.http.HttpMethods.HTTP_METHOD, constant("POST"))
```

And the equivalent spring sample:

```
<camelContext xmlns="http://activemq.apache.org/camel/schema/spring">
  <route>
    <from uri="direct:start"/>
    <setHeader headerName="http.requestMethod">
      <constant>POST</constant>
    </setHeader>
    <to uri="http://www.google.com"/>
    <to uri="mock:results"/>
  </route>
</camelContext>
```

## Configuring charset

If you are using POST to send data you can configure the charset using the Exchange property:

```
exchange.setProperty(Exchange.CHARSET_NAME, "iso-8859-1");
```

Or the HttpClient options: `httpClient.contentCharset=iso-8859-1`

## Sample with scheduled poll

The sample polls the Google homepage every 10 seconds and write the page to the file `message.html`

```
from("timer://foo?fixedRate=true&delay=0&period=10000")
  .to("http://www.google.com")
  .setHeader(FileComponent.HEADER_FILE_NAME, "message.html").to("file:target/google");
```

## URI Parameters from the endpoint URI

In this sample we have the complete URI endpoint that is just what you would have typed in a web browser. Multiple URI parameters can of course be set using the `&` as separator, just as you would in the web browser. Camel does no tricks here.

```
// we query for Camel at the Google page
template.sendBody("http://www.google.com/search?q=Camel", null);
```

## URI Parameters from the Message

```
Map headers = new HashMap();
headers.put(HttpProducer.QUERY, "q=Camel&lr=lang_en");
// we query for Camel and English language at Google
template.sendBody("http://www.google.com/search", null, headers);
```

In the header value above notice that it should **not** be prefixed with ? and you can separate parameters as usual with the & char.

## Getting the Response Code

You can get the http response code from the http component by getting the value from out message header with `HttpProducer.HTTP_RESPONSE_CODE`.

```
Exchange exchange = template.send("http://www.google.com/search", new Processor() {
    public void process(Exchange exchange) throws Exception {
        exchange.getIn().setHeader(HttpProducer.QUERY,
            constant("hl=en&q=activemq"));
    }
});
Message out = exchange.getOut();
int responseCode = out.getHeader(HttpProducer.HTTP_RESPONSE_CODE, Integer.class);
```

## Advanced Usage

If you need more control over the http producer you should use the `HttpComponent` where you can set various classes to give you custom behavior.

## Setting MaxConnectionsPerHost

The `HttpComponent` have a `org.apache.commons.httpclient.HttpConnectionManager` where you can configure various global configuration for the given component.

By global, we mean, that any endpoint the component creates has the same shared `HttpConnectionManager`. So if we want to set a different value for the max connection per host, we need to define on the http component and **not** on the endpoint URI that we usually uses. So here comes:

First we define the http component in spring XML. Yes we can use the same scheme name **http** that Camel otherwise will auto discover and create the component with default settings. What we need is to overrule this so we can set our options. In the sample below we set the max connection to 5 instead of the default of 2.

```
<bean id="http" class="org.apache.camel.component.http.HttpComponent">
  <property name="camelContext" ref="camel"/>
  <property name="httpConnectionManager" ref="myHttpConnectionManager"/>
</bean>
```



```

<bean id="myHttpConnectionManager"
class="org.apache.commons.httpclient.MultiThreadedHttpConnectionManager">
  <property name="params" ref="myHttpConnectionManagerParams"/>
</bean>

<bean id="myHttpConnectionManagerParams"
class="org.apache.commons.httpclient.params.HttpConnectionManagerParams">
  <property name="defaultMaxConnectionsPerHost" value="5"/>
</bean>

```

And then we can just use it as we normally do in our routes:

```

<camelContext id="camel" xmlns="http://camel.apache.org/schema/spring" trace="true">
  <route>
    <from uri="direct:start"/>
    <to uri="http://www.google.com"/>
    <to uri="mock:result"/>
  </route>
</camelContext>

```

## See Also

- [Configuring Camel](#)
- [Component](#)
- [Endpoint](#)
- [Getting Started](#)
- [Jetty](#)

## IBATIS

The **ibatis:** component allows you to query, poll, insert, update and delete data in a relational database using Apache iBATIS.

### URI format

```
ibatis:operationName
```

Where **operationName** is the name in the iBATIS XML configuration file which maps to the query, insert, update or delete operation you wish to evaluate.

### Options

None

## Message Headers

Camel will populate the result message, either IN or OUT with a header with the operationName used:

Header	Type	Description
org.apache.camel.ibatis.queryName	String	The <b>operationName</b> used (for example: insertAccount)

## Samples

For example if you wish to consume beans from a JMS queue and insert them into a database you could do.

```
from("activemq:queue:newAccount").  
to("ibatis:insertAccount");
```

Where **insertAccount** is the iBatis id in the SQL map file:

```
<!-- Insert example, using the Account parameter class -->  
<insert id="insertAccount" parameterClass="Account">  
insert into ACCOUNT (  
ACC_ID,  
ACC_FIRST_NAME,  
ACC_LAST_NAME,  
ACC_EMAIL  
)  
values (  
#id#, #firstName#, #lastName#, #emailAddress#  
)  
</insert>
```

## Scheduled polling example

Since this component does not support scheduled polling you need to use another mechanism for triggering the scheduled pools such as the Timer or Quartz components.

In the sample below we poll the database, every 30th second using the Timer component and sends the data to the JMS queue:

```
from("timer://pollTheDatabase?delay=30000").to("ibatis:selectAllAccounts").to("activemq:queue:allAccou
```

And the iBatis SQL map file used:

```
<!-- Select with no parameters using the result map for Account class. -->  
<select id="selectAllAccounts" resultMap="AccountResult">  
select * from ACCOUNT  
</select>
```

## See Also

- [Configuring Camel](#)
- [Component](#)
- [Endpoint](#)
- [Getting Started](#)

## IRC COMPONENT

The **irc:** component implements an IRC (Internet Relay Chat) transport.

### URI format

```
irc:host[:port]/#room
```

## See Also

- [Configuring Camel](#)
- [Component](#)
- [Endpoint](#)
- [Getting Started](#)

## JAVASPACE COMPONENT

The **javaspace:** component is a transport for working with any JavaSpace compliant implementation, this component has been tested with both the Blitz implementation and the GigaSpace implementation .

This component can be used for sending and receiving any object inheriting from the Jini Entry class, it's also possible to pass an id (Spring Bean) of a template that can be used for reading/taking the entries from the space.

This component can be also used for sending/receiving any serializable object acting as a sort of generic transport. The JavaSpace component contains a special optimization for dealing with the BeanExchange. It can be used, then, for invoking remotely a POJO using as a transport a JavaSpace.

This latter feature can be used for an easy implementation of the master/worker pattern where a POJO provides the business logic for the worker.

Look at the test cases for seeing the various usage option for this component.

### URI format

```
javaspace:jini://host?options
```

## Examples

### Sending and Receiving Entries

```
//Sending route  
from("direct:input").to("javaspace:jini://localhost?spaceName=mySpace");
```

```
//Receiving Route
```

```
from("javaspace:jini://localhost?spaceName=mySpace&templateId=template&verb=take");
```

In this case the payload can be any object inheriting from the Jini Entry.

### Sending and receiving serializable objects

Using the routes as above it's also possible to send and receive any serializable object. The camel component detects that the payload is not a Jini Entry and then it automatically wraps the payload into a Camel Jini Entry. In this way a JavaSpace can be used as a generic transport.

### Using JavaSpace as a remote invocation transport

The camel-javaspace component has been tailored to work in combination with the camel-bean component. It's possible, then, to call a remote POJO using JavaSpace as a transport:

```
from("direct:input").to("javaspace:jini://localhost?spaceName=mySpace");  
//Client side
```

```
from("javaspace:jini://localhost?concurrentConsumers=10&spaceName=mySpace")  
//Server side
```

In the code there are two test cases showing how to use the a POJO for realizing the master/worker pattern. The idea is to use the POJO for providing the business logic and relying on camel for sending/receiving requests/replies with the proper correlation.

### Options

Name	Default Value	Description
spaceName	null	This is the JavaSpace name
verb	take	This is the verb for getting JavaSpace entries, it can be: take or read
transactional	false	if true, sending and receiving of entries is performed under a transaction
transactionalTimeout	Long.MAX_VALUE	the transaction timeout

concurrentConsumers	1	the number of concurrent consumer getting entries from the JavaSpace
templateId	null	if present, this option it's a Spring Bean id to be used as a template for reading/taking entries

## Using camel-javaspac

To use this module you need to use the FUSE Mediation Router distribution. Or you could just add the following to your pom.xml, substituting the version number for the latest & greatest release.

```
<dependency>
  <groupId>org.apache.camel</groupId>
  <artifactId>camel-parent</artifactId>
  <version>1.4.0.0-fuse</version>
</dependency>
```

And ensure you are pointing at the maven repo

```
<repository>
  <id>open.ionam2</id>
  <name>IONA Open Source Community Release Repository</name>
  <url>http://repo.open.ionam.com/maven2</url>
  <snapshots>
    <enabled>false</enabled>
  </snapshots>
  <releases>
    <enabled>>true</enabled>
  </releases>
</repository>
```

## Building From Source

The source for camel-javaspac is available here: <https://projects.open.ionam.com/projects/svn/ionam/camel/trunk/components/camel-javaspac/>

You'll need to register with <http://open.ionam.com> to be able to access subversion.

The full FUSE distro is here: <https://projects.open.ionam.com/projects/svn/ionam/camel/trunk/>

## See Also

- Configuring Camel
- Component
- Endpoint
- Getting Started

## JBI COMPONENT

The **jbi:** component is provided by the ServiceMix Camel module and provides integration with a JBI Normalized Message Router such as provided by Apache ServiceMix

Following code

```
from("jbi:endpoint:http://foo.bar.org/MyService/MyEndpoint")
```

automatically exposes new endpoint to the bus where service QName is {http://foo.bar.org}MyService and endpoint name is MyEndpoint (refer to URI format later).

All that has to be done to use this endpoint is to send messages from some endpoint already declared (for example with `jms:endpoint`) to this JBI camel endpoint (the same way as messages are sent to EIP endpoints or any other endpoint) and camel will pick it up the same way as it picks any other messages.

Sending works in the same way:

```
to("jbi:endpoint:http://foo.bar.org/MyService/MyEndpoint")
```

Is used to send messages to JBI endpoint already deployed to the bus. It could be an endpoint exposed by `jms:endpoint`, `http:provider` or anything else.

### URI format

```
jbi:service:serviceNamespace[sep]serviceName  
jbi:endpoint:serviceNamespace[sep]serviceName[sep]endpointName  
jbi:name:endpointName
```

The separator used will be:

- '/' if the namespace looks like 'http://'
- ':' if the namespace looks like 'urn:foo:bar'

For more details of valid JBI URIs see the ServiceMix URI Guide.

Using the **jbi:service:** or **jbi:endpoint:** URI forms will set the service QName on the JBI endpoint to the exact one you give. Otherwise the default Camel JBI Service QName will be used which is

```
{http://activemq.apache.org/camel/schema/jbi}endpoint
```

### Examples

```
jbi:service:http://foo.bar.org/MyService  
jbi:endpoint:urn:foo:bar:MyService:MyEndpoint  
jbi:endpoint:http://foo.bar.org/MyService/MyEndpoint  
jbi:name:cheese
```



See below for information regarding using StreamSource types from ServiceMix in Camel.

## URI options

Name	Default value	Description
mep	<MEP of Camel Exchange>	Allows users to override the MEP being used for interacting with JBI (values are in-only, in-out, robust-in-out and in-optional-out)
operation	<value of the jbi.operation header property>	Specify the JBI operation to be used for the MessageExchange. If no value is supplied, the JBI binding will use the value of the jbi.operation header property

## Examples

```
jbi:service:http://foo.bar.org/MyService?mep=in-out      (override the MEP, use InOut
JBI MessageExchanges)
jbi:endpoint:urn:foo:bar:MyService:MyEndpoint?mep=in    (override the MEP, use
InOnly JBI MessageExchanges)
jbi:endpoint:urn:foo:bar:MyService:MyEndpoint?operation={http://www.mycompany.org}AddNumbers
(override the operation for the JBI Exchange to {http://www.mycompany.org}AddNumbers)
```

## Using Stream bodies

If you are using any stream types as bodies then you should be aware that a stream is only capable of being read once. So if you are enabling DEBUG logging then the body is usually debug logged and thus read. To cater for this Camel has `streamCaching` that caches the stream so it can be read multiple times.

```
from("jbi:endpoint:http://foo.bar.org/MyService/
MyEndpoint").streamCaching().to("xslt:transform.xsl", "bean:doSomething");
```

In **Camel 1.5** onwards the stream caching is default enabled, so adding `streamCaching()` is not needed.

## Creating a JBI Service Unit

If you have some Camel routes you want to deploy inside JBI as a Service Unit you can use the JBI Service Unit Archetype to create a new project.

If you have an existing maven project which you need to convert into a JBI Service Unit you may want to refer to the ServiceMix Maven JBI Plugins for further help. Basically you just need to make sure

- you have a spring XML file at **src/main/resources/camel-context.xml** which is used to boot up your routes inside the JBI Service Unit
- you change the pom's packaging to **jbi-service-unit**

Your pom.xml should look something like this to enable the jbi-service-unit packaging.

```
<project xmlns="http://maven.apache.org/POM/4.0.0" xmlns:xsi="http://www.w3.org/2001/
XMLSchema-instance"
  xsi:schemaLocation="http://maven.apache.org/POM/4.0.0 http://maven.apache.org/
maven-v4_0_0.xsd">

  <modelVersion>4.0.0</modelVersion>

  <groupId>myGroupId</groupId>
  <artifactId>myArtifactId</artifactId>
  <packaging>jbi-service-unit</packaging>
  <version>1.0-SNAPSHOT</version>

  <name>A Camel based JBI Service Unit</name>

  <url>http://www.myorganization.org</url>

  <properties>
    <camel-version>1.0.0</camel-version>
    <servicemix-version>3.3</servicemix-version>
  </properties>

  <dependencies>
    <dependency>
      <groupId>org.apache.camel</groupId>
      <artifactId>camel-jbi</artifactId>
      <version>${camel-version}</version>
    </dependency>

    <dependency>
      <groupId>org.apache.servicemix</groupId>
      <artifactId>servicemix-core</artifactId>
      <version>${servicemix-version}</version>
      <scope>provided</scope>
    </dependency>
  </dependencies>

  <build>
    <defaultGoal>install</defaultGoal>

    <plugins>
      <plugin>
        <groupId>org.apache.maven.plugins</groupId>
        <artifactId>maven-compiler-plugin</artifactId>
        <configuration>
          <source>1.5</source>
          <target>1.5</target>
```



```

    </configuration>
  </plugin>

  <!-- creates the JBI deployment unit -->
  <plugin>
    <groupId>org.apache.servicemix.tooling</groupId>
    <artifactId>jbi-maven-plugin</artifactId>
    <version>${servicemix-version}</version>
    <extensions>true</extensions>
  </plugin>
</plugins>
</build>
</project>

```

## See Also

- [Configuring Camel](#)
- [Component](#)
- [Endpoint](#)
- [Getting Started](#)
- [ServiceMix Camel module](#)
- [Using Camel with ServiceMix](#)
- [Cookbook on using Camel with ServiceMix](#)

## JCR COMPONENT

The `jcr:` component allows you to add nodes to a JCR (JSR-170) compliant content repository (e.g. Apache Jackrabbit).

### URI format

```
jcr://user:password@repository/path/to/node
```

### Usage

The `repository` element of the URI is used to look up the JCR Repository object in the Camel context registry.

If a message is sent to a producer endpoint created by this component:

- a new node is created in the content repository
- all the message properties of the `in` message will be transformed to JCR Value instances and added to the new node
- the node's UUID is returned in the `out` message

## Message properties

All message properties are converted to node properties, except for the `org.apache.camel.component.jcr.node_name` (you can refer to `JcrComponent.NODE_NAME` in your code), which is used to determine the node name.

## Example

The snippet below will create a node named `node` under the `/home/test` node in the content repository. One additional attribute will be added to the node as well: `my.contents.property` will contain the body of the message being sent.

```
from("direct:a").setProperty(JcrComponent.NODE_NAME, constant("node"))
    .setProperty("my.contents.property", body()).to("jcr://user:pass@repository/home/test");
```

## See Also

- [Configuring Camel](#)
- [Component](#)
- [Endpoint](#)
- [Getting Started](#)

## JDBC COMPONENT

The **jdbc:** component allows you to work with databases using JDBC queries and operations via SQL text as the message payload.

This component uses standard Java JDBC to work with the database, unlike the SQL Component component that uses `spring-jdbc`.

## URI format

```
jdbc:dataSourceName?options
```

This component only supports producer, meaning that you can not use routes with this component in the `from` type.

## Options

Name	Default Value	Description
------	---------------	-------------



So far endpoints from this component could be used only as producers. It means that you cannot use them in `from()` statement.

`readSize 0 / 2000`

The default maximum number of rows that can be read by a polling query. The default value is 2000 for Camel 1.5.0 or older. In newer releases the default value is 0.

## Result

The result is returned in the OUT body as a `ArrayList<HashMap<String, Object>>` list object with the result. The List contains the list of rows and the Map contains each row with the string key as the column name.

**Note:** This component fetches `ResultSetMetaData` to be able to return the column name as the key in the Map.

If the query is an update query the update count is returned in the OUT header `jdbc.updateCount`

## Samples

In the sample below we fetch the rows from the customer table.

First we register our datasource in the Camel registry as `testdb`:

```
JndiRegistry reg = super.createRegistry();
reg.bind("testdb", ds);
return reg;
```

Then we configure a route that routes to the JDBC component so the SQL will be executed, notice that we refer to the `testdb` datasource that was bound in the previous step:

```
// lets add simple route
public void configure() throws Exception {
    from("direct:hello").to("jdbc:testdb?readSize=100");
}
```

Or you can create a datasource in Spring like this:

```
<camelContext id="camel" xmlns="http://camel.apache.org/schema/spring">
  <route>
    <from uri="timer://kickoff?period=10000"/>
    <setBody>
      <constant>select * from customer</constant>
    </setBody>
    <to uri="jdbc:testdb"/>
    <to uri="mock:result"/>
  </route>
</camelContext>
```

```

</camelContext>
<!-- Just add a demo to show how to bind a date source for camel in Spring-->
<bean id="testdb" class="org.springframework.jdbc.datasource.DriverManagerDataSource">
  <property name="driverClassName" value="org.hsqldb.jdbcDriver"/>
  <property name="url" value="jdbc:hsqldb:mem:camel_jdbc" />
  <property name="username" value="sa" />
  <property name="password" value="" />
</bean>

```

And then we create the endpoint and sends the exchange containing the SQL query to execute in the in body. The result is returned in the out body.

```

// first we create our exchange using the endpoint
Endpoint endpoint = context.getEndpoint("direct:hello");
Exchange exchange = endpoint.createExchange();
// then we set the SQL on the in body
exchange.getIn().setBody("select * from customer order by ID");

// now we send the exchange to the endpoint, and receives the response from Camel
Exchange out = template.send(endpoint, exchange);

// assertions of the response
assertNotNull(out);
assertNotNull(out.getOut());
ArrayList<HashMap<String, Object>> data = out.getOut().getBody(ArrayList.class);
assertNotNull("out body could not be converted to an ArrayList - was: "
  + out.getOut().getBody(), data);
assertEquals(2, data.size());
HashMap<String, Object> row = data.get(0);
assertEquals("cust1", row.get("ID"));
assertEquals("jstrachan", row.get("NAME"));
row = data.get(1);
assertEquals("cust2", row.get("ID"));
assertEquals("nsandhu", row.get("NAME"));

```

### Sample - Polling the database every minute

If we want to poll a database using this component we need to combine this with a polling scheduler such as the Timer or Quartz etc.

In this sample we retrieve data from the database every 60th seconds.

```

from("timer://foo?period=60000").setBody(constant("select * from
customer")).to("jdbc:testdb").to("activemq:queue:customers");

```

### See Also

- [Configuring Camel](#)
- [Component](#)
- [Endpoint](#)
- [Getting Started](#)
- [SQL](#)

## JETTY COMPONENT

The **jetty:** component provides HTTP based endpoints for consuming HTTP requests that arrive at a http endpoint.

### URI format

```
jetty:http://hostname[:port][/resourceUri][?options]
```

### Options

Name	Default Value	Description
sessionSupport	false	The option to enable the session manager in the server side of Jetty.
httpClient.XXX	null	<b>Camel 1.5.1/2.0:</b> Configuration of the HttpClient Jetty uses. So setting <code>httpClient.idleTimeout=30000</code> will set the idle timeout to 30 seconds.
httpBindingRef	null	<b>Camel 1.5.1/2.0:</b> Reference to a <code>org.apache.camel.component.http.HttpBinding</code> in the Registry. <code>HttpBinding</code> can be used to customize how response should be written.

### Message Headers

Camel will add the following headers to the input message on the exchange

header	description
<code>http.requestMethod</code>	The request method: POST, GET, PUT, etc.
<code>org.apache.camel.component.http.query</code>	The HTTP query string ( <code>request.getQueryString</code> )

Camel will also populate **all** `request.parameter` and `request.headers`. For instance of a client request with `http://myserver/myserver?orderId=123` then the exchange will contain a header named `orderId` with the value `123`. This feature is introduced in Camel 1.5.

### Usage

You can only consume from endpoints generated by the Jetty component. Therefore it should only be used as input into your camel Routes. To issue HTTP requests against other HTTP endpoints you can use the HTTP Component

## Sample

In this sample we define a route where we expose a http service at `http://localhost:8080/myapp/myservice`:

```
from("jetty:http://localhost:9080/myapp/myservice").process(new MyBookService());
```

Our business logic is implemented in our `MyBookService` class where we can access the http request stuff and return a response.

**Note:** The assert is because the code is part of an unit test.

```
public class MyBookService implements Processor {
    public void process(Exchange exchange) throws Exception {
        // just get the body as a string
        String body = exchange.getIn().getBody(String.class);

        // we have access to the HttpServletRequest here and we can grab it if we need
        it
        HttpServletRequest req = exchange.getIn().getBody(HttpServletRequest.class);
        assertNotNull(req);

        // for unit testing
        assertEquals("bookid=123", body);

        // send a html response
        exchange.getOut(true).setBody("<html><body>Book 123 is Camel in
Action</body></html>");
    }
}
```

In the sample below we have a content based route that routes all requests that contain the URI parameter one to `mock:one` and all others to `mock:other`.

```
from("jetty:" + serverUri)
    .choice()
    .when().simple("in.header.one").to("mock:one")
    .otherwise()
    .to("mock:other");
```

So if a client sends the http request: `http://serverUri?one=hello` then camel-jetty will copy the http request parameter one to the `exchange.in.header`. Then we can use the simple language to route exchanges that contain this header to a specific endpoint and all others to another. If we used a more powerful language than Simple such as EI or OGNL would could also test for the parameter value and do routing based on the header value as well.

## Session Support

Session support can be used to enable `HttpSession` and being able to get this while processing the exchange.

```
<route>
  <from uri="jetty:http://0.0.0.0/myapp/myservice/?sessionSupport=true"/>
```



## Usage of localhost

When specifying `localhost` in URL Camel will expose the endpoint only on local interface, so it cannot be accessed from outside the machine it operates on.

If an endpoint should be exposed on specific network interface, specific IP address of this interface should be used. If an endpoint should be exposed on all interfaces `0.0.0.0` address should be used.

```
<processRef ref="myCode" />
<route>
```

And then we have a Processor that we configure as:

```
<bean id="myCode" class="com.mycompany.MyCodeProcessor" />
```

And in this processor we can get the `HttpSession`:

```
public void process(Exchange exchange) throws Exception {
    HttpSession session = ((HttpExchange)exchange).getRequest().getSession();
    ...
}
```

## SSL https Support

Jetty Provides SSL support out of the box. To configure Jetty to run in SSL mode, you simply set the uri to have `https://` as the parameter.

```
<from uri="jetty:https://0.0.0.0/myapp/myservice/" />
```

Jetty will need to know where to load your keystore from and what passwords to use in order to load the correct SSL certificate. The relevant System Properties set will point jetty in the right direction.

For the keystore path, use `jetty.ssl.keystore`

For the passwords, use `jetty.ssl.keypassword` and `jetty.ssl.password`

To create a certificate, and for Password issues, read the following documentation at the Jetty Site. <http://docs.codehaus.org/display/JETTY/How+to+configure+SSL>

## Default behavior for returning HTTP status codes

Camel will default use

`org.apache.camel.component.http.DefaultHttpBinding` that handles how response is written, and also setting the http status code.

If the exchange could be processed with success http status code 200 is returned. However if the OUT message contains a header `HttpProducer.HTTP_RESPONSE_CODE` then this code is used instead. To allow end users to set a specific status code.

If the exchange failed with an exception http status code 500 is returned, and the stacktrace is returned in the body.

## Customizing HttpBinding

### Available as of Camel 1.5.1/2.0

Camel will default use `org.apache.camel.component.http.DefaultHttpBinding` that handles how response is written.

This behavior can be customized by implementing your own `HttpBinding` class or extending `DefaultHttpBinding` and override appropriate methods.

In the sample below we use our own binding to change how exceptions should be returned:

```
public class MyHttpBinding extends DefaultHttpBinding {

    @Override
    public void doWriteExceptionResponse(Throwable exception, HttpServletResponse
response) throws IOException {
        // we override the doWriteExceptionResponse as we only want to alter the
binding how exceptions is
        // written back to the client.

        // we just return HTTP 200 so the client thinks its okay
response.setStatus(200);
        // and we return this fixed text
response.getWriter().write("Something went wrong but we dont care");
    }
}
```

Then we can have our binding registered in the registry as:

```
<bean id="mybinding" class="com.mycompany.MyHttpBinding"/>
```

And then we can refer to this binding when we configure the route:

```
<route>
  <from uri="jetty:http://0.0.0.0:8080/myapp/myservice?httpBindingRef=mybinding"/>
  <to uri="bean:doSomething"/>
</route>
```

## See Also

- [Configuring Camel](#)
- [Component](#)
- [Endpoint](#)
- [Getting Started](#)
- [Http](#)



## JING COMPONENT

The Jing component uses the Jing Library to perform XML validation of the message body using either

- RelaxNG XML Syntax
- RelaxNG Compact Syntax

Note that the MSV component can also support RelaxNG XML syntax.

### URI format

```
rng:someLocalOrRemoteResource  
rnc:someLocalOrRemoteResource
```

Where **rng** means use the RelaxNG XML Syntax whereas **rnc** means use RelaxNG Compact Syntax. The following examples show possible URI values

Example	Description
rng:foo/bar.rng	Will take the XML file <b>foo/bar.rng</b> on the classpath
rnc:http://foo.com/ bar.rnc	Will use the RelaxNG Compact Syntax file from the URL http://foo.com/bar.rnc

### Example

The following example shows how to configure a route from endpoint **direct:start** which then goes to one of two endpoints, either **mock:valid** or **mock:invalid** based on whether or not the XML matches the given RelaxNG Compact Syntax schema (which is supplied on the classpath).

```
<camelContext xmlns="http://camel.apache.org/schema/spring">  
  <route>  
    <from uri="direct:start"/>  
    <try>  
      <to uri="rnc:org/apache/camel/component/validator/jing/schema.rnc"/>  
      <to uri="mock:valid"/>  
  
      <catch>  
        <exception>org.apache.camel.ValidationException</exception>  
        <to uri="mock:invalid"/>  
      </catch>  
    </try>  
  </route>  
</camelContext>
```

### See Also

- Configuring Camel
- Component

- Endpoint
- Getting Started

## JMS COMPONENT

The JMS component allows messages to be sent to a JMS Queue or Topic; or messages to be consumed from a JMS Queue or Topic. The implementation of the JMS Component uses Spring's JMS support for declarative transactions, using Spring's `JmsTemplate` for sending and a `MessageListenerContainer` for consuming.

### URI format

```
jms:[topic:]destinationName?properties
```

So for example to send to queue FOO.BAR you would use

```
jms:FOO.BAR
```

You can be completely specific if you wish via

```
jms:queue:FOO.BAR
```

If you want to send to a topic called Stocks.Prices then you would use

```
jms:topic:Stocks.Prices
```

## Using Temporary Destinations

As of 1.4.0 of Camel you can use temporary queues using the following URL format

```
jms:temp:queue:foo
```

or temporary topics as

```
jms:temp:topic:bar
```

Where **foo** and **bar**, the text after the String **jms:temp:queue:** or **jms:temp:topic:**, are the names of the destinations. This enables multiple routes or processors or beans to refer to the same temporary destination. e.g. you can create 3 temporary destinations and use them in routes as inputs or outputs by referring to them by name.

### Notes

If you wish to use durable topic subscriptions, you need to specify both **clientId** and **durableSubscriberName**. Note that the value of the `clientId` must be unique and can only be used by a single JMS connection instance in your entire network. You may prefer to use Virtual Topics instead to avoid this limitation. More background on durable messaging [here](#).



## If you are using ActiveMQ

Note that the JMS component reuses Spring 2's JmsTemplate for sending messages. This is not ideal for use in a non-J2EE container and typically requires some caching JMS provider to avoid performance being lousy.

So if you intent to use Apache ActiveMQ as your Message Broker - which is a good choice as ActiveMQ rocks 😊, then we recommend that you either

- use the ActiveMQ component which is already configured to use ActiveMQ efficiently
- use the PoolingConnectionFactory in ActiveMQ

When using message headers; the JMS specification states that header names must be valid Java identifiers. So by default camel will ignore any headers which do not match this rule. So try name your headers as if they are valid Java identifiers. One added bonus of this is that you can then use your headers inside a JMS Selector - which uses SQL92 syntax which mandates Java identifier syntax for headers.

From Camel 1.4 a simple strategy for mapping headers names is used by default. The strategy is to replace any dots in the headername with underscore, and vice-versa when the header name is restored from the JMS message that was sent over the wire. What does this means? No more loosing method names to invoke on a bean component, no more loosing the filename header for the File Component etc.

Current header name strategy used for accepting header names in Camel:

- replace all dots with underscores (e.g. `org.apache.camel.MethodName => org_apache_camel_MethodName`)
- test if the name is a valid java identifier using the JDK core classes
- if test success then the header is added and sent over the wire, if not its dropped (logged at DEBUG level)

## Properties

You can configure lots of different properties on the JMS endpoint which map to properties on the JMSConfiguration POJO. **Notice:** Many of these properties maps to properties on Spring JMS that Camel uses for sending and receiving messages. So you can get more information about these properties by consulting the Spring documentation.

Property	Default Value	Description
<code>acceptMessagesWhileStopping</code>	<code>false</code>	Should the consumer accept messages while it is stopping
<code>acknowledgementModeName</code>	<code>"AUTO_ACKNOWLEDGE"</code>	The JMS acknowledgement name which is one of: TRANSACTED, CLIENT_ACKNOWLEDGE, AUTO_ACKNOWLEDGE, DUPS_OK_ACKNOWLEDGE
<code>acknowledgementMode</code>	<code>-1</code>	The JMS acknowledgement mode defined as an Integer. Allows to set vendor-specific extensions to the acknowledgement mode. For the regular modes prefer to use the <code>acknowledgementModeName</code> instead.



## For Consuming Messages cacheLevelName settings are vital!

If you are using Spring before 2.5.1 and Camel before 1.3.0 then you might want to set the **cacheLevelName** to be **CACHE\_CONSUMER** for maximum performance.

Due to a bug in earlier Spring versions causing a lack of transactional integrity, previous versions of Camel and Camel versions from 1.3.0 onwards when used with earlier Spring versions than 2.5.1 will default to use **CACHE\_CONNECTION**. See the JIRAs **CAMEL-163** and **CAMEL-294**.

Also if you are using **XA** or running in a **J2EE** container then you may want to set the **cacheLevelName** to be **CACHE\_NONE** as we have seen using **JBoss** with **TibCo EMS** and **JTA/XA** you must disable caching.

alwaysCopyMessage	false	If true then Camel will always make a JMS message copy of the message when it's passed to the producer for sending. Copying the message is needed in some situations such as when a replyToDestinationSelectorName is set (Camel will by the way set the alwaysCopyMessage to true if a replyToDestinationSelectorName is set)
autoStartup	true	Should the consumer container auto-startup
cacheLevelName	"CACHE_CONSUMER"	Sets the cache level by name for the underlying JMS resources. Possible values are: <b>CACHE_AUTO</b> , <b>CACHE_CONNECTION</b> , <b>CACHE_CONSUMER</b> , <b>CACHE_NONE</b> and <b>CACHE_SESSION</b> . See the Spring documentation.
cacheLevel	-1	Sets the cache level by id for the underlying JMS resources
clientId	null	Sets the JMS client ID to use. Note that this value if specified must be unique and can only be used by a single JMS connection instance. Its typically only required for durable topic subscriptions. You may prefer to use Virtual Topics instead
consumerType	Default	The consumer type to use, either: <b>Simple</b> , <b>Default</b> or <b>ServerSessionPool</b> . The consumer type determines which Spring JMS listener should be used. Default will use <code>org.springframework.jms.listener.DefaultMessageListenerContainer</code> . <b>Simple</b> will use <code>org.springframework.jms.listener.SimpleMessageListenerContainer</code> and <b>ServerSessionPool</b> will use <code>org.springframework.jms.listener.server.session.ServerSessionMessageListenerContainer</code> . If option <code>useVersion102=true</code> then Camel will of course use the JMS 1.0.2 Spring classes instead. <b>ServerSessionPool</b> is <b>@deprecated</b> and will be removed in Camel 2.0.
concurrentConsumers	1	Specifies the default number of concurrent consumers
connectionFactory	null	The default JMS connection factory to use for the <code>listenerConnectionFactory</code> and <code>templateConnectionFactory</code> if neither are specified
deliveryPersistent	true	Is persistent delivery used by default?
destination	null	(2.0 onwards) specifies the JMS Destination object to use on this endpoint
destinationName	null	(2.0 onwards) specifies the JMS destination name to use on this endpoint
disableReplyTo	false	Do you want to ignore the <code>JMSReplyTo</code> header and so treat messages as <code>InOnly</code> by default and not send a reply back?
durableSubscriptionName	null	The durable subscriber name for specifying durable topic subscriptions
eagerLoadingOfProperties	false	Enables eager loading of JMS properties as soon as a message is received which generally is inefficient as the JMS properties may not be required but sometimes can catch early any issues with the underlying JMS provider and the use of JMS properties. Can be used for testing purpose to ensure JMS properties can be understood and handled correctly.
exceptionListener	null	The JMS Exception Listener used to be notified of any underlying JMS exceptions
explicitQosEnabled	false	Set if the <code>deliveryMode</code> , <code>priority</code> or <code>timeToLive</code> should be used when sending messages
exposeListenerSession	true	Set if the listener session should be exposed when consuming messages
idleTaskExecutionLimit	1	Specify the limit for idle executions of a receive task, not having received any message within its execution. If this limit is reached, the task will shut down and leave receiving to other executing tasks (in case of dynamic scheduling; see the "maxConcurrentConsumers" setting).
jmsOperations	null	Allow to use your own implementation of the <code>org.springframework.jms.core.JmsOperations</code> interface. Camel uses <code>JmsTemplate</code> as default. Can be used for testing purpose, but not used much as stated in the spring API docs.
lazyCreateTransactionManager	true	(new added in Camel 2.0) If it is true, Camel will create a <code>JmsTransactionManager</code> if there is no <code>transactionManager</code> injected when the transacted is true
listenerConnectionFactory	null	The JMS connection factory used for consuming messages
maxConcurrentConsumers	1	Specifies the maximum number of concurrent consumers

maxMessagesPerTask	1	The number of messages per task
messageConverter	null	The Spring Message Converter
messageIdEnabled	true	When sending, should message IDs be added
messageTimestampEnabled	true	Should timestamps be enabled by default on sending messages
password	null	The password which is set for the connector factory
priority	-1	Values of > 1 specify the message priority when sending, if the explicitQoSEnabled property is specified (with 0 as the lowest priority and 9 as the highest)
preserveMessageQoS	false	Set to true if you want to send message using the QoS settings specified on the message, instead of the QoS settings on the JMS endpoint
pubSubNoLocal	false	Set whether to inhibit the delivery of messages published by its own connection
selector	null	Sets the JMS Selector which is an SQL 92 predicate used to apply to messages to filter them at the message broker. You may have to encode special characters such as = as %3D
receiveTimeout	none	The timeout when receiving messages
recoveryInterval	none	The recovery interval
replyToTempDestinationAffinity	endpoint	defines the component created temporary replyTo destination sharing strategy. Possible values are: component, endpoint or producer. <b>component</b> = a single temp queue is shared among all producers for a given component instance. <b>endpoint</b> = a single temp queue is shared among all producers for a given endpoint instance. <b>producer</b> = a single temp queue is created per producer.
replyToDestination	null	Provides an explicit reply to destination which overrides any incoming value of Message.getJMSReplyTo()
replyToDestinationSelectorName	null	Sets the JMS Selector using the fixed name to be used so you can filter out your own replies from the others, when using a shared queue (i.e. if you are not using a temporary reply queue).
replyToDeliveryPersistent	true	Is persistent delivery used by default for reply?
requestTimeout	20000	The timeout when sending messages
serverSessionFactory	null	<b>@deprecated</b> - will be removed in Camel 2.0. The JMS ServerSessionFactory if you wish to use ServerSessionFactory for consumption
subscriptionDurable	false	Enabled by default if you specify a durableSubscriberName and a clientId
taskExecutor	null	Allows you to specify a custom task executor for consuming messages
templateConnectionFactory	null	The JMS connection factory used for sending messages
timeToLive	null	Is a time to live specified when sending messages
transacted	false	If transacted mode will be used for sending/receiving messages using the InOnly Exchange Pattern. See section Enabling Transacted Consumption for more details.
transactedInOut	false	If transacted mode will be used when sending/receiving messages using the InOut Exchange Pattern. See section Enabling Transacted Consumption for more details.
transactionManager	null	The Spring transaction manager to use
transactionName	null	The name of the transaction to use
transactionTimeout	null	The timeout value of the transaction if using transacted mode
username	null	The username which is set for the connector factory
useMessageIDAsCorrelationID	false	Should JMSMessageID be used as JMSCorrelationID for InOut messages. Camel will by default use a GUID
useVersion102	false	Should the old JMS API be used

## Message Mapping between JMS and Camel

Camel will automatically map messages between `javax.jms.Message` and `org.apache.camel.Message`.

When sending a JMS message Camel will convert the body to the following JMS message:

Body Type	JMS Message	Comment
String	<code>javax.jms.TextMessage</code>	
<code>org.w3c.dom.Node</code>	<code>javax.jms.TextMessage</code>	The DOM will be converted to String
Map	<code>javax.jms.MapMessage</code>	

java.io.Serializable	javax.jms.ObjectMessage
byte[]	javax.jms.BytesMessage
java.io.File	javax.jms.BytesMessage
java.io.Reader	javax.jms.BytesMessage
java.io.InputStream	javax.jms.BytesMessage
java.nio.ByteBuffer	javax.jms.BytesMessage

When receiving a JMS message Camel will convert the JMS message to the following body type:

JMS Message	Body Type	Comment
javax.jms.TextMessage	String	
javax.jms.BytesMessage	byte[]	
javax.jms.MapMessage	Map<String, Object>	
javax.jms.ObjectMessage	Object	

### Message format when sending

The exchange that is sent over the JMS wire must conform to the JMS Message spec.

For the exchange.in.header the following rules apply for the **keys**:

- Keys stating with JMS or JMSX is reserved. All user keys will be dropped.
- exchange.in.headers keys must be literals and all be valid Java identifiers. (do not use dots in the key name)
- In Camel 1.4 onwards Camel will automatically replace all dots with underscore for key names. And vice-versa when Camel consumes JMS messages.

For the exchange.in.header the following rules apply for the **values**:

- The values must be primitives or their counter objects (such as Integer, Long, Character). String, CharSequence, Date, BigDecimal or BigInteger is all converted to their toString() representation. All other types is dropped.

Camel will log with category org.apache.camel.component.jms.JmsBinding at **DEBUG** level if it drops a given header value. Example:

```
2008-07-09 06:43:04,046 [main ] DEBUG JmsBinding
- Ignoring non primitive header: order of class:
org.apache.camel.component.jms.issues.DummyOrder with value: DummyOrder{orderId=333,
itemId=4444, quantity=2}
```

### Message format when receiving

Camel will add the following properties to the Exchange when it receives a message:

Property	Type	Description
<code>org.apache.camel.jms.replyDestination</code>	<code>javax.jms.Destination</code>	The reply destination

Camel will add the following JMS properties to the **IN** Message headers when it receives a JMS message:

Header	Type	Description
JMSCorrelationID	String	The JMS correlation id
JMSDeliveryMode	int	The JMS delivery mode
JMSDestination	<code>javax.jms.Destination</code>	The JMS destination
JMSExpiration	long	The JMS expiration
JMSMessageID	String	The JMS unique message id
JMSPriority	int	The JMS priority (with 0 as the lowest priority and 9 as the highest)
JMSRedelivered	boolean	Is the JMS message redelivered
JMSReplyTo	<code>javax.jms.Destination</code>	The JMS reply to destination
JMSTimestamp	long	The JMS timestamp
JMSType	String	The JMS type
JMSXGroupID	String	The JMS group id

As all the above information is standard JMS you can check the JMS documentation for further details.

## Configuring different JMS providers

You can configure your JMS provider inside the Spring XML as follows...

```
<camelContext id="camel" xmlns="http://camel.apache.org/schema/spring">
</camelContext>

<bean id="activemq" class="org.apache.camel.component.jms.JmsComponent">
  <property name="connectionFactory">
    <bean class="org.apache.activemq.ActiveMQConnectionFactory">
      <property name="brokerURL" value="vm://localhost?broker.persistent=false"/>
    </bean>
  </property>
</bean>
```

Basically you can configure as many JMS component instances as you wish and give them a **unique name via the id attribute**. The above example configures an 'activemq' component. You could do the same to configure MQSeries, TibCo, BEA, Sonic etc.

Once you have a named JMS component you can then refer to endpoints within that component using URIs. For example for the component name 'activemq' you can then refer to destinations as **activemq:[queue:]topic:]destinationName**. So you could use the same approach for working with all other JMS providers.

This works by the SpringCamelContext lazily fetching components from the spring context for the scheme name you use for Endpoint URIs and having the Component resolve the endpoint URIs.

## Using JNDI to find the ConnectionFactory

If you are using a J2EE container you might want to lookup in JNDI to find your ConnectionFactory rather than use the usual <bean> mechanism in spring. You can do this using Spring's factory bean or the new Spring XML namespace. e.g.

```
<bean id="weblogic" class="org.apache.camel.component.jms.JmsComponent">
  <property name="connectionFactory" ref="myConnectionFactory"/>
</bean>

<jee:jndi-lookup id="myConnectionFactory" jndi-name="jms/connectionFactory"/>
```

## Concurrent Consuming

A common requirement with JMS is to consume messages concurrently in many threads to achieve high throughput. As shown above you use the **concurrentConsumers** property above.

```
from("jms:SomeQueue?concurrentConsumers=20").
  bean(MyClass.class);
```

You can configure the properties on the JmsComponent if you wish or on specific endpoints via the URI or by configuring the JmsEndpoint directly.

## Enabling Transacted Consumption

A common requirement is to consume from a queue in a transaction then process the message using the Camel route. To do this just ensure you set the following properties on the component/endpoint

- transacted = true
- transactionManager = a Transaction Manager - typically the JmsTransactionManager

See also the Transactional Client EIP pattern for further details.





## Transaction and Request Reply over JMS

Note that when using Request Reply over JMS you cannot use a single transaction; as JMS will not send any messages until a commit is performed so the server side won't receive anything at all until the transaction commits. So with request/response you must commit a transaction after sending the first request and then use a separate transaction for receiving the response.

Its for this reason that the **transacted** property only applies to InOnly message Exchange Pattern. If you still want to use transacted for InOut then you must use **transactedInOut=true**.

To recap: if you have `transacted=true`, `transactedInOut=false` and are sending an InOut then the Exchange will **not** use transaction.

## Using request timeout

In the sample below we send a Request Reply style message [Exchange] (we use the `requestBody` method = InOut) to the slow queue for further processing in Camel and we wait for a return reply.

```
// send a in-out with a timeout for 5 sec
Object out = template.requestBody("activemq:queue:slow?requestTimeout=5000", "Hello
World");
```

## Samples

JMS is used in many examples for other components as well. But we provide a few samples below to get started.

## Receiving from JMS

In this sample we configure a route that receives JMS messages and routes the message to a POJO

```
from("jms:queue:foo").
    to("bean:myBusinessLogic");
```

You can of course use any of the EIP pattern so the route can be context based, such as filtering an order topic for the big spenders:

```
from("jms:topic:OrdersTopic").
    filter().method("myBean", "isGoldCustomer").
    to("jms:queue:BigSpendersQueue");
```

## Sending to a JMS

In the sample below we poll a file folder and send the file content to a JMS topic. As we want the content of the file as a `TextMessage` instead of a `BytesMessage` we need to convert the body to a `String`.

```
from("file://orders").
  convertBodyTo(String.class).
  to("jms:topic:OrdersTopic");
```

## Using Annotations

Camel also has annotations so you can use POJO Consuming and POJO Producing.

## Spring DSL sample

The sample above are using the Java DSL. Camel also supports using Spring XML DSL. Here is the big spender sample using Spring DSL:

```
<route>
  <from uri="jms:topic:OrdersTopic" />
  <filter>
    <method bean="myBean" method="isGoldCustomer" />
    <to uri="jms:queue:BigSpendersQueue" />
  </filter>
</route>
```

## Other samples

JMS is used a lot in other samples for other components and EIP patterns as well in this Camel documentation. So feel free to browse the documentation. If you have good time then check out the this tutorial that uses JMS but focuses on how well Spring Remoting and Camel works together [Tutorial-JmsRemoting](#).

### See Also

- [Configuring Camel](#)
- [Component](#)
- [Endpoint](#)
- [Getting Started](#)
- [Transactional Client](#)
- [Bean Integration](#)
- [Tutorial-JmsRemoting](#)

## JPA COMPONENT

The **jpa:** component allows you to work with databases using JPA (EJB 3 Persistence) such as for working with OpenJPA, Hibernate, TopLink to work with relational databases.

### Sending to the endpoint

Sending POJOs to the JPA endpoint inserts entities into the database. The body of the message is assumed to be an entity bean (i.e. a POJO with an `@Entity` annotation on it).

If the body does not contain an entity bean then use a Message Translator in front of the endpoint to perform the necessary conversion first.

### Consuming from the endpoint

Consuming messages removes (or updates) entities in the database. This allows you to use a database table as a logical queue, consumers take messages from the queue and then delete/update them to logically remove them from the queue.

If you do not wish to delete the entity when it has been processed you can specify **consumeDelete=false** on the URI. This will result in the entity being processed each poll.

If you would rather perform some update on the entity to mark it as processed (such as to exclude it from a future query) then you can annotate a method with `@Consumed` which will be invoked on your entity bean when the entity bean is consumed.

### URI format

```
jpa:[entityClassName]
```

For sending to the endpoint, the **entityClassName** is optional. If specified it is used to help use the Type Converter to ensure the body is of the correct type.

For consuming the **entityClassName** is mandatory.

### Options

Name	Default Value	Description
entityType	entityClassName	Is the provided entityClassName from the URI
persistenceUnit	camel	the JPA persistence unit used by default
consumeDelete	true	Option for JpaConsumer only. Enables / disables whether or not the entity is deleted after it is consumed.

consumeLockEntity	true	Option for JpaConsumer only. Enables / disables whether or not to use exclusive locking of each entity while processing the results from the pooling.
flushOnSend	true	Option for JpaProducer only. Flushes the EntityManager after the entity beans has been persisted.
maximumResults	-1	Option for JpaConsumer only. Set the maximum number of results to retrieve on the Query.
consumer.delay	500	Option for JpaConsumer only. Delay in millis between each poll.
consumer.initialDelay	1000	Option for JpaConsumer only. Millis before polling starts.
consumer.userFixedDelay	false	Option for JpaConsumer only. <b>true</b> to use fixed delay between pools, otherwise fixed rate is used. See ScheduledExecutorService in JDK for details.

### Example

See Tracer Example for an example using JPA to store traced messages into a database.

### See Also

- [Configuring Camel](#)
- [Component](#)
- [Endpoint](#)
- [Getting Started](#)
- [Tracer Example](#)

## JT/400 COMPONENT

The `jt400` component allows you to exchanges messages with an AS/400 system using data queues. This components is only available in Camel 1.5 and above.

### URI format

```
jt400://user:password@system/QSYS.LIB/LIBRARY.LIB/QUEUE.DTAQ
```

## URI options

Name	Default value	Description
ccsid	default system CCSID	specifies the CCSID to use for the connection with the AS/400 system
format	text	specifies the data format for sending messages valid options are: text (represented by String) and binary (represented by byte[ ])
consumer.delay	500	Delay in millis between each poll
consumer.initialDelay	1000	Millis before polling starts
consumer.userFixedDelay	false	<b>true</b> to use fixed delay between pools, otherwise fixed rate is used. See ScheduledExecutorService in JDK for details.

## Usage

When configured as a consumer endpoint, the endpoint will poll a data queue on a remote system. For every entry on the data queue, a new Exchange is sent with the entry's data in the 'in' message's body, formatted as either a String or a byte[ ], depending on the format. For a provider endpoint, the 'in' message body contents will be put on the data queue as either raw bytes or text.

## Example

In the snippet below, the data for an exchange sent to the `direct:george` will be put in the data queue `PENNYLANE` in library `BEATLES` on a system named `LIVERPOOL`. Another user connects to the same data queue to receive the information from the data queue and forward it to the `mock:ringo` endpoint.

```
public class Jt400RouteBuilder extends RouteBuilder {  
  
    @Override  
    public void configure() throws Exception {  
        from("direct:george").to("jt400://GEORGE:EGROEG@LIVERPOOL/QSYS.LIB/BEATLES.LIB/  
PENNYLANE.DTAQ");  
        from("jt400://RINGO:OGNIR@LIVERPOOL/QSYS.LIB/BEATLES.LIB/  
PENNYLANE.DTAQ").to("mock:ringo");  
    }  
}
```

```
}  
}
```

## See Also

- [Configuring Camel](#)
- [Component](#)
- [Endpoint](#)
- [Getting Started](#)

## LDAP COMPONENT

The **ldap:** component allows you to perform searches in LDAP servers using filters as the message payload.

This component uses standard JNDI (`javax.naming`) to access the server.

### URI format

```
ldap:ldapServerUrl?options
```

This component only supports producer, meaning that you can not use routes with this component in the `from` type.

### Options

Name	Default Value	Description
base	ou=system	The base DN for searches
scope	subtree	Search the whole subtree. Value must be one of: "object", "onelevel" or "subtree"

### Result

The result is returned in the out body as a

`ArrayList<javax.naming.directory.SearchResult>` list object with the result.

### Samples

In the sample below we fetch the rows from the customer table.

First we register our datasource in the Camel registry as `testdb`:

```
JndiRegistry reg = super.createRegistry();
reg.bind("localhost:" + port, getWiredContext());
return reg;
```

Then we configure a route that routes to the LDAP component so the search will be executed, notice that we refer to the LdapContext that was bound in the previous step:

```
public void configure() throws Exception {
    from("direct:start").to("ldap:localhost:" + port + "?base=ou=system");
}
```

And then we create the endpoint and sends the exchange containing the LDAP filter to execute in the in body. The result is returned in the out body.

```
Endpoint endpoint = context.getEndpoint("direct:start");
Exchange exchange = endpoint.createExchange();
// then we set the LDAP filter on the in body
exchange.getIn().setBody("!(ou=test1)");

// now we send the exchange to the endpoint, and receives the response from
Camel
Exchange out = template.send(endpoint, exchange);

// assertions of the response
assertNotNull(out);
assertNotNull(out.getOut());
Collection<SearchResult> data = out.getOut().getBody(Collection.class);
assertNotNull("out body could not be converted to a Collection - was: " +
out.getOut().getBody(), data);

assertFalse(contains("uid=test1,ou=test,ou=system", data));
assertTrue(contains("uid=test2,ou=test,ou=system", data));
assertTrue(contains("uid=testNoOU,ou=test,ou=system", data));
assertTrue(contains("uid=tcruiase,ou=actors,ou=system", data));
}

@Override
protected JndiRegistry createRegistry() throws Exception {
    JndiRegistry reg = super.createRegistry();
    reg.bind("localhost:" + port, getWiredContext());
    return reg;
}

@Override
protected RouteBuilder createRouteBuilder() throws Exception {
    return new RouteBuilder() {
        public void configure() throws Exception {
            from("direct:start").to("ldap:localhost:" + port + "?base=ou=system");
        }
    };
}
}
```

## Sample - Polling the server every minute

If we want to poll an LDAP server using this component we need to combine this with a polling scheduler such as the Timer or Quartz etc.

In this sample we retrieve data every 60th seconds.

```
from("timer://foo?period=60000").setBody(constant("o=apache")).  
to("ldap:localhost:1024").to("activemq:queue:committers");
```

## See Also

- [Configuring Camel](#)
- [Component](#)
- [Endpoint](#)
- [Getting Started](#)

## LIST COMPONENT

**deprecated:** is renamed to the Browse component in Camel 2.0

The List component provides a simple `BrowsableEndpoint` which can be useful for testing, visualisation tools or debugging. The exchanges sent to the endpoint are all available to be browsed.

## URI format

```
list:someName
```

Where **someName** can be any string to uniquely identify the endpoint.

## Sample

In the route below we have the list component to be able to browse the Exchanges that is passed through:

```
from("activemq:order.in").to("list:orderReceived").to("bean:processOrder");
```

Then we will be able to inspect the received exchanges from java code:

```
private CamelContext context;  
  
public void inspectRecievedOrders() {  
    BrowsableEndpoint browse = context.getEndpoint("list:orderReceived",  
    BrowsableEndpoint.class);  
    List<Exchange> exchanges = browse.getExchanges();  
    ...  
    // then we can inspect the list of received exchanges from Java  
    for (Exchange exchange : exchanges) {  
        String payload = exchange.getIn().getBody();  
    }  
}
```



```
    ...  
  }  
}
```

### See Also

- [Configuring Camel](#)
- [Component](#)
- [Endpoint](#)
- [Getting Started](#)
- [Browse](#)

## LOG COMPONENT

The **log:** component logs message exchanges to the underlying logging mechanism. Camel uses commons-logging which allows you to configure logging via

- [Log4j](#)
- [JDK 1.4 logging](#)
- [Avalon](#)
- [SimpleLog](#) - a simple provider in commons-logging

Refer to the commons-logging user guide for a more complete overview of how to use and configure commons-logging.

### URI format

```
log:loggingCategory[?level=loggingLevel][options]
```

Where **loggingCategory** is the name of the logging category to use and **loggingLevel** is the logging level such as DEBUG, INFO, WARN, ERROR - the default is INFO

By default Camel uses a regular logging that logs every exchange. However Camel also ships with a Throughput logger that is used if the `groupSize` option is specified.

### Options

Option	Default	Type	Description
level	INFO	String	Logging level to use. Possible values: FATAL, ERROR, WARN, INFO, DEBUG, TRACE, OFF
groupSize	null	Integer	An integer that specifies a group size for throughput logging. By default regular logging is used.

## Formatting

The log formats the execution of exchanges to log lines.

The log uses by default `LogFormatter` to format the log output.

`LogFormatter` has the following options:

Option	Default	Description
<code>showExchangeId</code>	false	To output the unique exchange id.
<code>showProperties</code>	false	Output the exchange properties
<code>showHeaders</code>	false	Output the in message headers
<code>showBodyType</code>	true	Output the in body Java type
<code>showBody</code>	true	Output the in body
<code>showOut</code>	false	If the exchange has an out message then its also shown
<code>showAll</code>	false	quick option for turning all options on
<code>multiline</code>	false	if <b>enabled</b> then each information is logged on a new line

## Regular logger sample

In the route below we logs the incoming orders at `DEBUG` level before the order is processed.

```
from("activemq:orders").to("log:com.mycompany.order?level=DEBUG").to("bean:processOrder");
```

And using Spring DSL as the route:

```
<route>
  <from uri="activemq:orders"/>
  <to uri="log:com.mycompany.order?level=DEBUG"/>
  <to uri="bean:processOrder"/>
</route>
```

## Regular logger with formatter sample

In the route below we logs the incoming orders at `INFO` level before the order is processed.

```
from("activemq:orders").
  to("log:com.mycompany.order?showAll=true&multiline=true").to("bean:processOrder");
```

## Throughput logger sample

In the route below we log the throughput of the incoming orders at `DEBUG` level grouped by 10 messages.

```
from("activemq:orders").
  to("log:com.mycompany.order?level=DEBUG?groupSize=10").to("bean:processOrder");
```

## See Also

- [Configuring Camel](#)
- [Component](#)
- [Endpoint](#)
- [Getting Started](#)
- [Tracer](#)
- [How do I use log4j](#)
- [How do I use Java 1.4 logging](#)

## MAIL COMPONENT

The mail component provides access to Email via Spring's Mail support and the underlying JavaMail system.

### URI format

```
smtp://[user-info@]host:port[?password=somepwd]
pop3://[user-info@]host:port[?password=somepwd]
imap://[user-info@]host:port[?password=somepwd]
```

which supports either POP, IMAP or SMTP underlying protocols.

It is possible to omit the user-info and specify the username as a URI parameter instead

```
smtp://host:port?password=somepwd&username=someuser
```

Such as:

```
smtp://mycompany.mailserver:30?password=tiger&username=scott
```

### SSL support

Camel have support for secure mail protocols. Just add a s to the scheme such as:

```
smtps://[user-info@]host:port[?password=somepwd]
pop3s://[user-info@]host:port[?password=somepwd]
imaps://[user-info@]host:port[?password=somepwd]
```

### Default Ports

As of Camel 1.4 support for default port number has been added. If the port number is omitted Camel will determine based on the protocol the port number to use.

<b>Protocol</b>	<b>Default Port Number</b>
SMTP	25
SMTPS	465



### Classpath issue

If you have trouble with sending mails that for instance doesn't contain any subject, has wrong recipients or other unforeseen errors then it could be because of having `geronimo-javamail_1.4_spec-1.3.jar` in the classpath. This was the culprit in a long bug hunt reported in CAMEL-869.



### POP3 or IMAP

POP3 has some limitations and end users is encouraged to use IMAP if possible.



### SSL Information

Its the underlying mail framework that is handling the SSL support. Camel uses SUN JavaMail. However SUN JavaMail only trusts certificates issued by well known Certificate Authorities. So if you have issued your own certificate you have to import it into the local Java keystore file (see SSLNOTES.txt in JavaMail for details).

If you are using your own signed certificates sometimes it can be cumbersome to install your certificate in the local keystore. Camel provides a test option

**dummyTrustManager** that when enabled will accept any given certificate.

**Notice:** this is strongly discouraged not using in production environments.

POP3	110
POP3S	995
IMAP	143
IMAPS	993

### Options

Property	Default	Description
host		The host name or IP address to connect to
port	See Default Ports	The TCP port number to connect on
user-info		The user name on the email server

username		The user name on the email server configured as a URI pa
password	null	The users password to use, can be omitted if the mail ser
ignoreUriScheme	false	If disabled Camel will use the scheme to determine the tra (imap, smtp etc.)
defaultEncoding	null	The default encoding to use for MimeMessages
contentType	text/plain	New option in Camel 1.5. The mail message content type mails.
folderName	INBOX	The folder to poll
destination	user-info@host	<b>@deprecated</b> use To option. The TO recipients (the r
to	user-info@host	The TO recipients (the receivers of the mail). This option
CC	null	The CC recipients (the receivers of the mail). This option
BCC	null	The BCC recipients (the receivers of the mail). This optio
from	camel@localhost	The FROM email address
deleteProcessedMessages	true/false	Deletes the messages after they have been processed. Thi DELETED flag on the mail message. If <b>false</b> then the flag 1.5 the default setting is now <b>false</b> .
processOnlyUnseenMessages	false/true	As of Camel 1.4 its possible to configure MailConsumer to (eg new messages) or all. Note Camel will always skip del option to <b>true</b> will filter to only unseen messages. As of now <b>true</b> . POP3 does not support the SEEN flag so this POP3, instead use IMAP.
fetchSize	-1	As of Camel 1.4 a maximum number of messages to consu This can be used to not exhaust a mail server if a mailbox messages. Default value of -1 means no fetch size and all n Setting the value to 0 is a special corner case where Came at all.
debugMode	false	As of Camel 1.4 its possible to enable the debug mode on SUN Mail framework will default output to System.out.
connectionTimeout	30000	As of Camel 1.4 the connection timeout can be configure
dummyTrustManager	false	As of Camel 1.4 testing SSL connections can be easier if e that trust any given certificate. Notice this is only to be us provide any security at all.
consumer.initialDelay	1000	Millis before the polling starts

consumer.delay	60000	As of Camel 1.4 the default consumer delay is now 60 seconds. Camel will therefore only poll the mailbox once a minute to not exhaust the mail server. The default value in Camel 1.3 is 500 millis.
consumer.useFixedDelay	false	<b>true</b> to use fixed delay between pools, otherwise fixed rate. See ScheduledExecutorService in JDK for details.
mail.XXX	null	As of <b>Camel 2.0</b> you can set any additional java mail properties. To set a special property when using POP3 you can now poll a mail URI such as: <code>mail.pop3.forgettopheaders=true</code> . Other options, such as: <code>mail.pop3.forgettopheaders=true&amp;mail.mime.charset=UTF-8</code> .

### Defaults changed in Camel 1.4

As of Camel 1.4 the default consumer delay is now 60 seconds. Camel will therefore only poll the mailbox once a minute to not exhaust the mail server. The default value in Camel 1.3 is 500 millis.

### Defaults changed in Camel 1.5

In Camel 1.5 the following default options has changed:

- `deleteProcessedMessages` is now **false** as we felt Camel should not delete mails on the mail server by default.
- `processOnlyUnseenMessages` is now **true** as we felt Camel should only poll new mails by default.

### Mail Message Content

Camel will use the Exchange Message IN body as the MimeMessage text content. The body is converted to String.class.

Camel copies all the Exchange Message IN headers to the MimeMessage headers.

The subject of the MimeMessage can be configured using a header property on the in message. The code below demonstrates this:

```
from("direct:a").setHeader("subject", constant(subject)).to("smtp://james2@localhost");
```

The same applies for other MimeMessage headers such as recipients, so you can use a header property as the TO:

```
Map map = new HashMap();
map.put("To", "davsclaus@apache.org");
map.put("From", "jstrachan@apache.org");
map.put("Subject", "Camel rocks");
```

```
String body = "Hello Claus.\nYes it does.\n\nRegards James.";
template.sendBodyAndHeaders("smtp://davsclaus@apache.org", body, map);
```

## Headers take precedence over pre configured recipients

From Camel 1.5 onwards the recipients from the message headers will always take precedence over any pre configured. The idea is that if you provide any recipients in the message headers then its what you get (WYSIWYG). The pre configuration is just there for fallback or if you use fixed recipients.

In the sample code below the mail is sent to `davsclaus@apache.org` since it will take precedence over the pre configured. Even if we have CC pre configured they will not receive the mail. The headers is all or nothing, it will not mix and match between headers and pre configured. You either get one or the other.

```
Map<String, Object> headers = new HashMap<String, Object>();
headers.put("to", "davsclaus@apache.org");

template.sendBodyAndHeaders("smtp://admin@localhost?to=info@mycompany.com",
"Hello World", headers);
```

## Multiple recipients easier configuration

Also new in Camel 1.5 is the possibility to set multiple recipients in a single String parameter. This applied to both the headers and pre configuration.

```
Map<String, Object> headers = new HashMap<String, Object>();
headers.put("to", "davsclaus@apache.org ; jstrachan@apache.org ;
ningjiang@apache.org");
```

In the sample above we use semi colon as separators. Camel support both semicolon = ; and comma = , as separator char.

## SUN JavaMail

SUN JavaMail is used under the covers for consuming and producing mails.

We encourage end-users to consult these links when using either POP3 or IMAP protocol.

Notice that especially POP3 have limited features compared to IMAP.

- SUN POP3 API
- SUN IMAP API
- And generally about the MAIL Flags

## Samples

We start with a simple route that sends the messages received from a JMS queue as emails. The email account will be the admin account on `mymailserver.com`.

```
from("jms://queue:subscription").to("smtp://admin@mymailserver.com?password=secret");
```

In the next sample we will poll a mailbox for new emails once every minute. Notice that we use the special consumer parameter for setting the poll interval **consumer.delay** as 60000 millis = 60 seconds.

```
from("imap://admin@mymailserver.com?password=secret&processOnlyUnseenMessages=true&consumer.delay=60000");
```

In this sample we want to send a mail to multiple recipients. This feature was introduced in camel 1.4.

```
// all the recipients of this mail are:
// To: camel@riders.org , easy@riders.org
// CC: me@you.org
// BCC: someone@somewhere.org
String recipients =
"&To=camel@riders.org,easy@riders.org&CC=me@you.org&BCC=someone@somewhere.org";

from("direct:a").to("smtp://you@mymailserver.com?password=secret&From=you@apache.org"
+ recipients);
```

## Sending mail with attachment sample

Attachments is a new feature in Camel 1.4 that of course is also supported by the mail component. In the sample below we send a mail message containing a plain text message with a logo file attachment.

```
// create an exchange with a normal body and attachment to be produced as email
Endpoint endpoint =
context.getEndpoint("smtp://james@mymailserver.com?password=secret");

// create the exchange with the mail message that is multipart with a file and a Hello
World text/plain message.
Exchange exchange = endpoint.createExchange();
Message in = exchange.getIn();
in.setBody("Hello World");
in.addAttachment("logo.jpeg", new DataHandler(new FileDataSource("src/test/data/
logo.jpeg")));

// create a producer that can produce the exchange (= send the mail)
Producer producer = endpoint.createProducer();
// start the producer
producer.start();
// and let it go (processes the exchange by sending the email)
producer.process(exchange);
```

## SSL sample

In this sample we want to poll our Google mail inbox for mails. Google mail requires to use SSL and have it configured for other clients to access your mailbox. This is done by logging into your google mail and change your settings to allow IMAP access. Google have extensive documentation how to do this.



```
from("imaps://imap.gmail.com?username=YOUR_USERNAME@gmail.com&password=YOUR_PASSWORD"
+
"&deleteProcessedMessages=false&processOnlyUnseenMessages=true&consumer.delay=60000").to("log:newmail")
```

The route above will poll the google mail inbox for new mails once every minute and log it to the newmail logger category.

Running the sample with DEBUG logging enabled we can monitor the progress in the logs:

```
2008-05-08 06:32:09,640 DEBUG MailConsumer - Connecting to MailStore
imaps://imap.gmail.com:993 (SSL enabled), folder=INBOX
2008-05-08 06:32:11,203 DEBUG MailConsumer - Polling mailfolder:
imaps://imap.gmail.com:993 (SSL enabled), folder=INBOX
2008-05-08 06:32:11,640 DEBUG MailConsumer - Fetching 1 messages. Total 1 messages.
2008-05-08 06:32:12,171 DEBUG MailConsumer - Processing message: messageNumber=[332],
from=[James Bond <007@mi5.co.uk>], to=YOUR_USERNAME@gmail.com], subject=[...
2008-05-08 06:32:12,187 INFO newmail - Exchange[MailMessage: messageNumber=[332],
from=[James Bond <007@mi5.co.uk>], to=YOUR_USERNAME@gmail.com], subject=[...
```

## SSL sample with dummyTrustManager

In the next sample we want to sent mails from Camel using our own mail server using secure connections. As our own mail server is using our own signed certificate we need either to

1. install our certificate in the local keystore Camel uses
2. use the dummyTrustManager option for testing purpose to see if the secure communication works

In the sample we use the dummyTrustManager option:

```
from("seda:mailsToSend").to("imaps://ourmailserver.com?username=camelmail&password=secret&dummyTrustManager")
```

## Consuming mails with attachment sample

In this sample we poll a mailbox and want to store all attachments from the mails as files. First we define our route to poll the mailbox. As this sample is based on google mail, it uses the same route as shown in the SSL sample:

```
from("imaps://imap.gmail.com?username=YOUR_USERNAME@gmail.com&password=YOUR_PASSWORD"
+
"&deleteProcessedMessages=false&processOnlyUnseenMessages=true&consumer.delay=60000").process(new
MyMailProcessor());
```

Instead of logging the mail we use a processor where we can process the mail from java code:

```
public void process(Exchange exchange) throws Exception {
    // the API is a bit clunky so we need to loop
    Map<String, DataHandler> attachments = exchange.getIn().getAttachments();
    if (attachments.size() > 0) {
        for (String name : attachments.keySet()) {
            DataHandler dh = attachments.get(name);
            // get the file name
            String filename = dh.getName();
        }
    }
}
```

```

        // get the content and convert it to byte[]
        byte[] data =
exchange.getContext().getTypeConverter().convertTo(byte[].class, dh.getInputStream());

        // write the data to a file
        FileOutputStream out = new FileOutputStream(filename);
        out.write(data);
        out.flush();
        out.close();
    }
}
}

```

As you can see the API to handle attachments is a bit clunky but it's there so you can get the `javax.activation.DataHandler` so you can handle the attachments using standard API.

### See Also

- [Configuring Camel](#)
- [Component](#)
- [Endpoint](#)
- [Getting Started](#)

## MINA COMPONENT

The **mina:** component is a transport for working with Apache MINA

### URI format

```

mina:tcp://hostname[:port]
mina:udp://hostname[:port]
mina:multicast://hostname[:port]
mina:vm://hostname[:port]

```

From Camel 1.3 onwards you can specify a codec in the Registry using the **codec** option. If you are using TCP and no codec is specified then the `textline` flag is used to determine if text line based codec or object serialization should be used instead. By default the object serialization is used.

For UDP/Multicast if no codec is specified the default uses a basic `ByteBuffer` based codec.

Multicast also has a shorthand notation **mcast**.

The VM protocol is used as a direct forwarding mechanism in the same JVM. See the MINA VM-Pipe API documentation for details.

A `MinaProducer` has a default timeout value of 30 seconds, while it waits for a response from the remote server.

In normal usage camel-mina only supports marshalling the body content - message headers and exchange properties will not be sent. However the option **transferExchange** does allow to transfer the exchange itself over the wire. See options below.

## Options

Option	Default Value	Description
codec	null	As of 1.3 or later you can refer to a named ProtocolCodecFactory instance in your Registry such as your Spring ApplicationContext which is then used for the marshalling
textline	false	Only used for TCP. If no codec is specified then you can use this flag in 1.3 or later to indicate a text line based codec; if not specified or the value is false then Object Serialization is assumed over TCP.
textlineDelimiter	DEFAULT	<b>Camel 1.5.1/2.0</b> Only used for TCP and if <b>textline=true</b> . Sets the text line delimiter to use. Possible values are: DEFAULT, AUTO, WINDOWS, UNIX or MAC. If none provided Camel will default use DEFAULT. This delimiter is used to mark the end of text.
sync	false/true	As of 1.3 or later you can configure the exchange pattern to be either InOnly (default) or InOut. Setting sync=true means a synchronous exchange (InOut), where the client can read the response from MINA (The exchange out message). The default value has changed in Camel 1.5 to true. In older releases the default value is false.
lazySessionCreation	false	As of 1.3 or later session can be lazy created to avoid exceptions if the remote server is not up and running when the Camel producer is started.
timeout	30000	As of 1.3 or later you can configure the timeout while waiting for a response from a remote server. The timeout unit is in millis, so 60000 is 60 seconds. The timeout is only used for MinaProducer.

encoding	JVM Default	As of 1.3 or later you can configure the encoding (is a charset name) to use for the TCP textline codec and the UDP protocol. If not provided Camel will use the JVM default Charset.
transferExchange	false	Only used for TCP. As of 1.3 or later you can transfer the exchange over the wire instead of just the body. The following fields is transferred: in body, out body, fault body, in headers, out headers, fault headers, exchange properties, exchange exception. This requires that the objects are Serializable. Camel will exclude any non serializable objects and log it at WARN level.
minaLogger	false	As of 1.3 or later you can enable Apache MINA logging filter. Apache MINA uses slf4j logging at INFO level to log all input and output.

### Default behavior changed

In Camel 1.5 the sync option has changed its default value from false to true, as we felt it was confusing for end-users when they used Mina to call remote servers and Camel wouldn't wait for the response.

In Camel 1.4 or later `codec=textline` is no longer supported. Use the `textline=true` option instead.

### Using custom codec

See the Mina documentation how to write your own codec. To use your custom codec with camel-mina you should register your codec in the Registry such as the Spring XML file. Then use the **codec** option to set your codec with its bean id. See HL7 that has a custom codec.

### Sample with sync=false

In this sample we let Camel expose a service that listen for TCP connections on port 6200. We use the **textline** codec. In our route we create the mina in the from to create the consumer that listen on port 6200:

```
from("mina:tcp://localhost:6200?textline=true&sync=false").to("mock:result");
```

As the sample is part of an unit test we test it by sending some data on port 6200 to it.

```
MockEndpoint mock = getMockEndpoint("mock:result");
mock.expectedBodiesReceived("Hello World");

template.sendBody("mina:tcp://localhost:6200?textline=true&sync=false", "Hello World");
```

```
assertMockEndpointsSatisfied();
```

## Sample with sync=true

In the next sample we have a more common use-case where we expose a TCP service on port 6201 also using the textline codec. However this time we want to return a response and indicate that we support this so we set the sync option to true on the consumer.

```
from("mina:tcp://localhost:6201?textline=true&sync=true").process(new Processor() {  
    public void process(Exchange exchange) throws Exception {  
        String body = exchange.getIn().getBody(String.class);  
        exchange.getOut().setBody("Bye " + body);  
    }  
});
```

Then we test it by sending some data and retrieving the response using the `template.requestBody()` method. As we know the response is a `String` we cast it to `String` and can assert that the response is in fact something we have dynamically set in our processor code logic.

```
String response =  
(String) template.requestBody("mina:tcp://localhost:6201?textline=true&sync=true",  
    "World");  
assertEquals("Bye World", response);
```

## Sample with Spring DSL

Spring DSL can of course also be used for Mina. In the simple sample below we expose a TCP server on port 5555:

```
<route>  
    <from uri="mina:tcp://localhost:5555?textline=true"/>  
    <to uri="bean:myTCPOrderHandler"/>  
</route>
```

In the route above we expose a TCP server on port 5555 using the textline codec and we let a spring bean with the id `myTCPOrderHandler` handle the request and return a reply. For instance this can be done as:

```
public String handleOrder(String payload) {  
    ...  
    return "Order: OK"  
}
```

## Configuring Mina endpoints using Spring bean style

### Available as of Camel 2.0

Configuration of Mina endpoints is now possible using regular Spring bean style configuration in the Spring DSL.

However configuring Apache Mina itself is quite complex to setup the acceptor, connector as you can **not** use simple setters. To resolve this we will leverage the `MinaComponent` as a Spring factory bean to configure this for us. If you really need to configure this yourself there are setters on the `MinaEndpoint` to set these when needed.

The sample below shows the factory approach:

```
<!-- Creating mina endpoints is a bit complex so we reuse MinaComponnet
as a factory bean to create our endpoint, this is the easiest to do -->
<bean id="myMinaFactory" class="org.apache.camel.component.mina.MinaComponent"/>

<!-- This is our mina endpoint configured with spring, we will use the factory above
to create it for us. The goal is to invoke the createEndpoint method with the
mina configuration parameter we defined using the constructor-arg option -->
<bean id="myMinaEndpoint"
    factory-bean="myMinaFactory"
    factory-method="createEndpoint">
    <constructor-arg index="0" ref="myMinaConfig"/>
</bean>

<!-- this is our mina configuration with plain properties -->
<bean id="myMinaConfig" class="org.apache.camel.component.mina.MinaConfiguration">
    <property name="protocol" value="tcp"/>
    <property name="host" value="localhost"/>
    <property name="port" value="1234"/>
    <property name="sync" value="false"/>
</bean>
```

And then we can refer to our endpoint directly in the route such as:

```
<route>
    <!-- here we route from or mina endpoint we have defined above -->
    <from ref="myMinaEndpoint"/>
    <to uri="mock:result"/>
</route>
```

## See Also

- [Configuring Camel](#)
- [Component](#)
- [Endpoint](#)
- [Getting Started](#)

## MOCK COMPONENT

Testing of distributed and asynchronous processing is notoriously difficult. The Mock, Test and DataSet endpoints work great with the Camel Testing Framework to simplify your unit and integration testing using Enterprise Integration Patterns and Camel's large range of Components together with the powerful Bean Integration.

The Mock component provides a powerful declarative testing mechanism which is similar to jMock in that it allows declarative expectations to be created on any Mock endpoint before a test begins. Then the test is ran which typically fires messages to one or more endpoints and finally the expectations can be asserted in a test case to ensure the system worked as expected.

This allows you to test various things like:

- the correct number of messages are received on each endpoint
- that the correct payloads are received, in the right order
- that messages arrive on an endpoint in order, using some Expression to create an order testing function
- that messages arrive match some kind of Predicate such as that specific headers have certain values, or that parts of the messages match some predicate such as by evaluating an XPath or XQuery Expression

**Note** that there is also the Test endpoint which is-a Mock endpoint but which also uses a second endpoint to provide the list of expected message bodies and automatically sets up the Mock endpoint assertions. i.e. its a Mock endpoint which automatically sets up its assertions from some sample messages in a File or database for example.

## URI format

```
mock:someName?options
```

Where **someName** can be any string to uniquely identify the endpoint

## Options

Option	Default	Description
reportGroup	null	A size to use a throughput logger for reporting

## Simple Example

Here's a simple example of MockEndpoint in use. First the endpoint is resolved on the context. Then we set an expectation, then after the test has run we assert our expectations are met.

```
MockEndpoint resultEndpoint = context.resolveEndpoint("mock:foo", MockEndpoint.class);
resultEndpoint.expectedMessageCount(2);

// send some messages
...

// now lets assert that the mock:foo endpoint received 2 messages
resultEndpoint.assertIsSatisfied();
```

You typically always call the `assertIsSatisfied()` method to test that the expectations were met after running a test.

Camel will by default wait 20 seconds when the `assertIsSatisfied()` is invoked. This can be configured by setting the `setResultWaitTime(millis)` method.

## Setting expectations

You can see from the javadoc of `MockEndpoint` the various helper methods you can use to set expectations. The main methods available are as follows:

Method	Description
<code>expectedMessageCount(int)</code>	to define the expected message count on the endpoint
<code>expectedMinimumMessageCount(int)</code>	to define the minimum number of expected messages on the endpoint
<code>expectedBodiesReceived(...)</code>	to define the expected bodies that should be received (in order)
<code>expectedHeaderReceived(...)</code>	to define the expected header that should be received
<code>expectsAscending(Expression)</code>	to add an expectation that messages are received in order using the given Expression to compare messages
<code>expectsDescending(Expression)</code>	to add an expectation that messages are received in order using the given Expression to compare messages
<code>expectsNoDuplicates(Expression)</code>	to add an expectation that no duplicate messages are received; using an Expression to calculate a unique identifier for each message. This could be something like the <code>JMSMessageID</code> if using JMS, or some unique reference number within the message.

Here's another example:

```
resultEndpoint.expectedBodiesReceived("firstMessageBody", "secondMessageBody",  
"thirdMessageBody");
```

## Adding expectations to specific messages

In addition you can use the `message(int messageIndex)` method to add assertions about a specific message that is received.

For example to add expectations of the headers or body of the first message (using zero based indexing like `java.util.List`), you can use this code

```
resultEndpoint.message(0).header("foo").isEqualTo("bar");
```



There are some examples of the Mock endpoint in use in the camel-core processor tests.

## A Spring Example

First here's the spring.xml file

```
<camelContext xmlns="http://camel.apache.org/schema/spring">
  <route>
    <from uri="file:src/test/data?noop=true" />
    <filter>
      <xpath>/person/city = 'London'</xpath>
      <to uri="mock:matched" />
    </filter>
  </route>
</camelContext>

<bean id="myBean" class="org.apache.camel.spring.mock.MyAssertions" scope="singleton" />
```

As you can see it defines a simple routing rule which consumes messages from the local `src/test/data` directory. The **noop** flag just means not to delete or move the file after its been processed.

Also note we instantiate a bean called **myBean**, here is the source of the `MyAssertions` bean.

```
public class MyAssertions implements InitializingBean {
    @EndpointInject(uri = "mock:matched")
    private MockEndpoint matched;

    @EndpointInject(uri = "mock:notMatched")
    private MockEndpoint notMatched;

    public void afterPropertiesSet() throws Exception {
        // lets add some expectations
        matched.expectedMessageCount(1);
        notMatched.expectedMessageCount(0);
    }

    public void assertEndpointsValid() throws Exception {
        // now lets perform some assertions that the test worked as we expect
        Assert.assertNotNull("Should have a matched endpoint", matched);
        Assert.assertNotNull("Should have a notMatched endpoint", notMatched);
        MockEndpoint.assertIsSatisfied(matched, notMatched);
    }
}
```

The bean is injected with a bunch of Mock endpoints using the `@EndpointInject` annotation, it then sets a bunch of expectations on startup (using Spring's `InitializingBean` interface and `afterPropertiesSet()` method) before the `CamelContext` starts up.

Then in our test case (which could be `JUnit` or `TesNG`) we lookup **myBean** in Spring (or have it injected into our test) and then invoke the **assertEndpointsValid()** method on it to verify that the mock endpoints have their assertions met. You could then inspect the message

exchanges that were delivered to any of the endpoints using the `getReceivedExchanges()` method on the Mock endpoint and perform further assertions or debug logging.

Here is the actual JUnit test case we use.

## See Also

- [Configuring Camel](#)
- [Component](#)
- [Endpoint](#)
- [Getting Started](#)
- [Spring Testing](#)

## MSMQ COMPONENT

The **msmq** component is a transport for working with Microsoft Message Queuing. This component natively sends and receives direct allocated `ByteBuffer` instances. This allows to access the JNI layer without expensive memory copying.

In fact using `ByteBuffer` created with the method `allocateDirect` can be passed to the JNI layer and the native code is able to directly access the memory.

It's up to the developer to marshal/unmarshal any other kind of payloads to/from direct allocated `ByteBuffer` instances.

Look at the tests to see some usage examples.

## URI format

```
msmq:msmqQueueName
```

## Examples

```
msmq:DIRECT=OS:localhost\\private$\\test?concurrentConsumers=1
```

```
msmq:DIRECT=OS:localhost\\private$\\test?deliveryPersistent=true&priority=5
```

## Options

Name	Default Value	Description
<code>deliveryPersistent</code>	false	if true the message is put persistently on the queue
<code>priority</code>	5	the message priority, it's a value in the range 1-7
<code>timeToLive</code>	INFINITE	the time in seconds before a message is discarded if it doesn't reach the destination

concurrentConsumers	1	the numbers of consumers that get messages from the queue at the same time
initialBufferSize	128	the initial buffer size
incrementBufferSize	128	if the initial buffer size is not enough big for containing the received message it's incremented by incrementBufferSize

## Using camel-msmq

To use this module you need to use the FUSE Mediation Router distribution. Or you could just add the following to your pom.xml, substituting the version number for the latest & greatest release.

```
<dependency>
  <groupId>org.apache.camel</groupId>
  <artifactId>camel-parent</artifactId>
  <version>1.3.4.0-fuse</version>
</dependency>
```

And ensure you are pointing at the maven repo

```
<repository>
  <id>open.ionam2</id>
  <name>IONA Open Source Community Release Repository</name>
  <url>http://repo.open.ionam.com/maven2</url>
  <snapshots>
    <enabled>false</enabled>
  </snapshots>
  <releases>
    <enabled>true</enabled>
  </releases>
</repository>
```

## Building From Source

The source for camel-msmq is available here: <https://projects.open.ionam.com/projects/svn/ionam/camel/trunk/components/camel-msmq/>

You'll need to register with <http://open.ionam.com> to be able to access subversion.

The full FUSE distro is here: <https://projects.open.ionam.com/projects/svn/ionam/camel/trunk/>

## See Also

- [Configuring Camel](#)
- [Component](#)
- [Endpoint](#)
- [Getting Started](#)

## MSV COMPONENT

The MSV component performs XML validation of the message body using the MSV Library using any of the XML schema languages supported such as XML Schema or RelaxNG XML Syntax.

Note that the JIng component also supports RelaxNG Compact Syntax

### URI format

```
msv:someLocalOrRemoteResource
```

Where **someLocalOrRemoteResource** is some URL to a local resource on the classpath or a full URL to a remote resource or resource on the file system. For example

- `msv:org/foo/bar.rng`
- `msv:file:../foo/bar.rng`
- `msv:http://acme.com/cheese.rng`

### Example

The following example shows how to configure a route from endpoint **direct:start** which then goes to one of two endpoints, either **mock:valid** or **mock:invalid** based on whether or not the XML matches the given RelaxNG XML Schema (which is supplied on the classpath).

```
<camelContext xmlns="http://camel.apache.org/schema/spring">
  <route>
    <from uri="direct:start" />
    <try>
      <to uri="msv:org/apache/camel/component/validator/msv/schema.rng" />
      <to uri="mock:valid" />

      <catch>
        <exception>org.apache.camel.ValidationException</exception>
        <to uri="mock:invalid" />
      </catch>
    </try>
  </route>
</camelContext>
```

### See Also

- [Configuring Camel](#)
- [Component](#)
- [Endpoint](#)
- [Getting Started](#)

## POJO COMPONENT

The **pojo:** component is now just an alias for the Bean component.

**Has been removed in Camel 2.0.**

### See Also

- [Configuring Camel](#)
- [Component](#)
- [Endpoint](#)
- [Getting Started](#)

## QUARTZ COMPONENT

The **quartz:** component provides a scheduled delivery of messages using the Quartz scheduler.

Each endpoint represents a different timer (in Quartz terms, a Trigger and JobDetail).

### URI format

```
quartz://timerName?parameters
quartz://groupName/timerName?parameters
quartz://groupName/timerName/cronExpression
```

You can configure the Trigger and JobDetail using the parameters (if not using cron expression)

Parameter	Description
trigger.repeatCount	How many times should the timer repeat for?
trigger.repeatInterval	The amount of time in milliseconds between repeated triggers
job.name	Sets the name of the job
stateful	Uses a Quartz StatefulJob instead of the default Job

For example the following routing rule will fire 2 timer events to the endpoint **mock:results**

```
from("quartz://myGroup/
myTimerName?trigger.repeatInterval=2&trigger.repeatCount=1").to("mock:result");
```

When using a StatefulJob the JobDataMap is re-persisted after every execution of the job, thus preserving state for the next execution.

### Message Headers

Camel adds the getters from Quartz Execution Context as header values. These headers is added:

calendar, fireTime, jobDetail, jobInstance, jobRunTime, mergedJobDataMap, nextFireTime, previousFireTime, refireCount,

result, scheduledFireTime, scheduler, trigger, triggerName, triggerGroup.

The fireTime header contains the java.util.Date for when the exchange was fired.

## Using Cron Triggers

Quartz supports Cron-like expressions for specifying timers in a handy format. You can use these expressions in the URI; though to preserve valid URI encoding we allow / to be used instead of spaces and \$ to be used instead of ?.

For example the following will fire a message at 12pm (noon) every day

```
from("quartz://myGroup/myTimerName/0/0/12/*/*/$").to("activemq:Totally.Rocks");
```

which is equivalent to using the cron expression

```
0 0 12 * * ?
```

The following table shows the URI character encodings we use to preserve valid URI syntax

URI Character	Cron character
'/'	' '
'\$'	'?'

## See Also

- [Configuring Camel](#)
- [Component](#)
- [Endpoint](#)
- [Getting Started](#)
- [Timer](#)

## QUEUE COMPONENT

The **queue:** component provides asynchronous SEDA behaviour so that messages are exchanged on a BlockingQueue and consumers are invoked in a separate thread pool to the producer.

Note that queues are only visible within a single CamelContext. If you want to communicate across CamelContext instances such as to communicate across web applications, see the VM component.

Note also that this component has nothing to do with JMS, if you want a distributed SEA then try using either JMS or ActiveMQ or even MINA



## Deprecated

To avoid confusion with JMS queues, this component is now deprecated in 1.1 onwards. Please use the SEDA component instead

### URI format

```
queue:someName
```

Where **someName** can be any string to uniquely identify the endpoint within the current CamelContext

### See Also

- [Configuring Camel](#)
- [Component](#)
- [Endpoint](#)
- [Getting Started](#)

## REF COMPONENT

The **ref:** component is used for lookup of existing endpoints bound in the Registry.

### URI format

```
ref:someName
```

Where **someName** can be any string which is used to lookup the endpoint in the Registry.

### Runtime lookup

This component can be used when you need dynamic discovery of endpoints in the Registry where you can compute the URI at runtime. Then you can lookup the endpoint using:

```
// lookup the endpoint
String myEndpointRef = "bigspenderOrder";
Endpoint endpoint = context.getEndpoint("ref:" + myEndpointRef);

Producer producer = endpoint.createProducer();
Exchange exchange = producer.createExchange();
exchange.getIn().setBody(payloadToSend);
// send the exchange
producer.process(exchange);
...
```

And you could have a list of endpoints defined in the Registry such as:

```
<camelContext id="camel" xmlns="http://activemq.apache.org/camel/schema/spring">
  <endpoint id="normalOrder" uri="activemq:order.slow" />
  <endpoint id="bigspenderOrder" uri="activemq:order.high" />
</camelContext>
```

## Sample

In the sample below we use the `ref` in the URI to reference the endpoint with the spring id `endpoint2`:

```
<bean id="mybean" class="org.apache.camel.spring.example.DummyBean">
  <property name="endpoint" ref="endpoint1" />
</bean>

<camelContext id="camel" xmlns="http://camel.apache.org/schema/spring">
  <endpoint id="endpoint1" uri="direct:start" />
  <endpoint id="endpoint2" uri="mock:end" />

  <route>
    <from ref="endpoint1" />
    <to uri="ref:endpoint2" />
  </route>
</camelContext>
```

You could of course have used the `ref` attribute instead:

```
<to ref="endpoint2" />
```

That is more commonly used.

## See Also

- [Configuring Camel](#)
- [Component](#)
- [Endpoint](#)
- [Getting Started](#)

## RMI COMPONENT

The **rmi**: component bind the PojoExchanges to the RMI protocol (JRMP).

Since this binding is just using RMI, normal RMI rules still apply in regards to what the methods can be used over it. This component only supports PojoExchanges that carry a method invocation that is part of an interface that extends the Remote interface. All parameters in the method should be either Serializable or Remote objects too.

## URI format

```
rmi://rmi-regisitry-host:rmi-registry-port/registry-path
```



For example:

```
rmi://localhost:1099/path/to/service
```

## Using

To call out to an existing RMI service registered in an RMI registry, create a Route similar to:

```
from("pojo:foo").to("rmi://localhost:1099/foo");
```

To bind an existing camel processor or service in an RMI registry, create a Route like:

```
RmiEndpoint endpoint= (RmiEndpoint) endpoint("rmi://localhost:1099/bar");  
endpoint.setRemoteInterfaces(ISay.class);  
from(endpoint).to("pojo:bar");
```

Notice that when binding an inbound RMI endpoint, the Remote interfaces exposed must be specified.

## Options

Name	Default Value	Description
method	null	As of 1.3 or later you can set the name of the method to invoke

## See Also

- [Configuring Camel](#)
- [Component](#)
- [Endpoint](#)
- [Getting Started](#)

## RSS COMPONENT

The **rss** component is used for polling RSS feeds. Camel will default poll the feed every 60th seconds.

**Note:** The component currently only supports polling (consuming) feeds.

**New in Camel 2.0**

### URI format

```
rss:rssUri
```

Where **rssUri** is the URI to the RSS feed to poll.

## Options

Property	Default	Description
splitEntries	true	If <b>true</b> Camel will poll the feed and for the subsequent polls return each entry poll by poll. If the feed contains 7 entries then Camel will return the first entry on the first poll, the 2nd entry on the next poll, until no more entries where as Camel will do a new update on the feed. If <b>false</b> then Camel will poll a fresh feed on every invocation.
filter	true	Is only used by the split entries to filter the entries to return. Camel will default use the UpdateDateFilter that only return new entries from the feed. So the client consuming from the feed never receives the same entry more than once. The filter will return the entries ordered by the newest last.
lastUpdate	null	Is only used by the filter, as the starting timestamp for selection never entries (uses the entry.updated timestamp). Syntax format is: yyyy-MM-ddTHH:MM:ss. Example: 2007-12-24T17:45:59.
feedHeader	true	Sets whether to add the ROME SyndFeed object as a header.
sortEntries	false	If splitEntries is true, this sets whether to sort those entries by updated date.
consumer.delay	60000	Delay in millis between each poll
consumer.initialDelay	1000	Millis before polling starts
consumer.userFixedDelay	false	<b>true</b> to use fixed delay between pools, otherwise fixed rate is used. See ScheduledExecutorService in JDK for details.

## Exchange data types

Camel will set the in body on the returned Exchange with a ROME SyndFeed. Depending on the splitEntries flag Camel will either return a SyndFeed with one SyndEntry or a List of SyndEntrys.

Option	Value	Behavior
--------	-------	----------

splitEntries	true	Only a single entry from the currently being processed feed is set in the new exchange feed.
splitEntries	false	The entire list of entries from the feed is set in the new exchange feed.

Camel can also set the entire SyndFeed object on the in header (see feedHeader option above to disable):

```
exchange.in.header("org.apache.camel.component.rss.feed", feed)
```

## RSS Dataformat

The RSS component ships with an RSS dataformat that can be used to convert between String (as XML) and ROME RSS model objects.

- marshal = from ROME SyndFeed to XML String
- unmarshal = from XML String to ROME SyndFeed

A route using this would look something like this:

```
from("rss:file:src/test/data/rss20.xml?splitEntries=false&consumer.delay=1000").marshal().rss().to("mock:marshal");
```

The idea is to be able to use Camel's lovely built in expressions for manipulating RSS messages. As shown below, an XPath expression can be used to filter the RSS message:

```
// only entries with Camel in the title will get through the filter
from("rss:file:src/test/data/rss20.xml?splitEntries=true&consumer.delay=100")
    .marshal().rss().filter().xpath("//item/
title[contains(., 'Camel')]").to("mock:result");
```

## Merging multiple incoming feeds

To merge multiple incoming feeds into a single feed, you can utilize a custom AggregationCollection provided with camel-rss. An example usage would look something like this:

```
from("rss:file:src/test/data/rss20.xml?sortEntries=true&consumer.delay=50").to("seda:temp");
from("rss:file:target/rss20.xml?sortEntries=true&consumer.delay=50").to("seda:temp");

from("seda:temp").aggregate(new
AggregateRssFeedCollection()).batchTimeout(5000L).to("mock:result");
```

Here we use a Seda queue to gather up entries from two RSS feeds. The entries are then fed into a custom aggregator which combines these entries into a single ROME SyndFeed object.

## Filtering entries

You can filter out entries quite easily by using XPath as shown in the data format section above. You can also utilize Camel's Bean Integration to implement your own conditions. For instance, a filter equivalent to the XPath example above would be:

```
// only entries with Camel in the title will get through the filter
from("rss:file:src/test/data/rss20.xml?splitEntries=true&consumer.delay=100").
    filter().method("myFilterBean", "titleContainsCamel").to("mock:result");
```

The custom bean for this would be

```
public static class FilterBean {
    public boolean titleContainsCamel(@Body SyndFeed feed) {
        SyndEntry firstEntry = (SyndEntry) feed.getEntries().get(0);
        return firstEntry.getTitle().contains("Camel");
    }
}
```

## See Also

- [Configuring Camel](#)
- [Component](#)
- [Endpoint](#)
- [Getting Started](#)

## SEDA COMPONENT

The **seda:** component provides asynchronous SEDA behavior so that messages are exchanged on a `BlockingQueue` and consumers are invoked in a separate thread to the producer.

Note that queues are only visible within a single `CamelContext`. If you want to communicate across `CamelContext` instances such as to communicate across web applications, see the `VM` component.

This component does not implement any kind of persistence or recovery if the `VM` terminates while messages are yet to be processed. If you need persistence, reliability or distributed SEDA then try using either `JMS` or `ActiveMQ`.

## URI format

```
seda:someName
```

Where **someName** can be any string to uniquely identify the endpoint within the current `CamelContext`



## Synchronous

The Direct component provides synchronous invocation of any consumers when a producer sends a message exchange.

### Options

Name	Default	Description
size	1000	The maximum size of the SEDA queue
concurrentConsumers	1	Number of threads that process exchanges

### Thread pools

Be aware that adding a thread pool to a seda endpoint by doing something like:

```
from("seda:stageName").thread(5).process(...)
```

can wind up with two BlockQueues. One from seda endpoint and one from the workqueue of the thread pool which may not be what you want. Instead, you might want to consider configuring a Direct endpoint with a thread pool which can process messages both synchronously and asynchronously. For example:

```
from("direct:stageName").thread(5).process(...)
```

You can also directly configure number of threads that process messages on seda endpoint using `concurrentConsumers` parameter.

### Sample

In the route below we use the SEDA queue to send the request to this async queue to be able to send a fire-and-forget message for further processing in another thread, and return a constant reply in this thread to the original caller.

```
public void configure() throws Exception {
    from("direct:start")
        // send it to the seda queue that is async
        .to("seda:next")
        // return a constant response
        .transform(constant("OK"));

    from("seda:next").to("mock:result");
}
```

Here we send a Hello World message and expects the reply to be OK.

```
Object out = template.requestBody("direct:start", "Hello World");
assertEquals("OK", out);
```

The "Hello World" message will be consumed from the SEDA queue from another thread for further processing, since this is from an unit test it will be sent to a mock endpoint where we can do assertions in the unit test.

### See Also

- [Configuring Camel](#)
- [Component](#)
- [Endpoint](#)
- [Getting Started](#)
- [Direct](#)

## SMOOKS

The Smooks component supports the Smooks Library for EDI parsing. The **camel-smooks** library is provided by the Camel Extra project which hosts all \*GPL related components for Camel.

It is **only** the EDI parsing feature that is implemented in this component. The other features from Smooks is covered in existing camel components.

Parsing from a any given data source to EDI is implemented using Camel Data Format.

## EDI DATAFORMAT

This component ships with a EDI dataformat that can be used to format from a `java.io.InputStream` to XML as a `org.w3c.Document` Object.

- `marshal` = currently not supported by Smooks
- `unmarshal` = from stream to XML (can be used when reading EDI files)

The `EDIDataFormat` must be configured with either a:

- `setSmooksConfig(configfile)` = a fully Smooks configuration file
- `setMappingModel(modelfile)` = just the mapping model xml file and Camel will use a default Smooks configuration

To use the data format simply instantiate an instance, set the configuration (above) and invoke the `unmarshal` operation in the route builder:

```
DataFormat edi = new EDIDataFormat();
edi.setMappingModel("my-order-mapping.xml");
...
from("file://edi/in").
    unmarshal(edi).
    to("jms:queue:edi");
```

And you can also provide the full Smooks configuration file where you can configure Smooks as you want, in case the default configuration isn't useful:

```

DataFormat edi = new EDIDataFormat();
edi.setSmooksConfig("my-smooks-config.xml");
...
from("file://edi/in").
    unmarshal(edi).
    to("jms:queue:edi");

```

## Dependencies

To use EDI in your camel routes you need to add the a dependency on **camel-smooks** which implements this data format.

This component is hosted at the Camel Extra project since the Smooks library uses a licenses which cant be included directly in an Apache project.

## SPRING INTEGRATION COMPONENT

The **spring-integration:** component provides a bridge for Camel components to talk to spring integration endpoints.

### URI format

```
spring-integration:defaultChannelName[?options]
```

Where **defaultChannelName** represents the default channel name which is used by the Spring Integration Spring context. It will equal to the inputChannel name for the Spring Integration consumer and the outputChannel name for the Spring Integration provider.

### Options

Name	Description	Example	Required	de val
inputChannel	The spring integration input channel name this endpoint wants to consume from that is defined in the spring context	inputChannel=requestChannel	No	
outputChannel	The spring integration output channel name to send message to the spring integration context	outputChannel=replyChannel	No	

inOut	The exchange pattern that spring integration endpoint should use	inOut=true	No	
consumer.delay	Delay in millis between each poll	consumer.delay=60000	No	500
consumer.initialDelay	Millis before polling starts	consumer.initialDelay=10000	No	100
consumer.userFixedDelay	true to use fixed delay between pools, otherwise fixed rate is used. See ScheduledExecutorService in JDK for details.	consumer.userFixedDelay=false	No	false

## Usage

Spring Integration component is a bridge which connects Spring Integration endpoints through the Spring integration's input and output channels with the Camel endpoints. In this way, we can send out the Camel message to Spring Integration endpoints or receive the message from Spring Integration endpoint in Camel routing context.

## Examples

### Using the Spring Integration Endpoint

You could setup the Spring Integration Endpoint by using the URI

```
<beans:beans xmlns="http://www.springframework.org/schema/integration"
  xmlns:xsi="http://www.w3.org/2001/XMLSchema-instance"
  xmlns:beans="http://www.springframework.org/schema/beans"
  xsi:schemaLocation="http://www.springframework.org/schema/beans
    http://www.springframework.org/schema/beans/
spring-beans-2.5.xsd
    http://www.springframework.org/schema/integration
    http://www.springframework.org/schema/integration/
spring-integration-1.0.xsd
    http://camel.apache.org/schema/spring
    http://camel.apache.org/schema/spring/camel-spring.xsd">
```



```

<channel id="inputChannel"/>
<channel id="outputChannel"/>
<channel id="onewayChannel"/>

<service-activator input-channel="inputChannel"
    ref="helloService"
    method="sayHello"/>

<service-activator input-channel="onewayChannel"
    ref="helloService"
    method="greet"/>

<beans:bean id="helloService"
class="org.apache.camel.component.spring.integration.HelloWorldService"/>

<camelContext id="camel" xmlns="http://camel.apache.org/schema/spring">
<route>
<from uri="direct:twowayMessage"/>
<!-- Using the & as the separator of & -->
<to
uri="spring-integration:inputChannel?inOut=true&inputChannel=outputChannel"/>
</route>
<route>
<from uri="direct:onewayMessage"/>
<to uri="spring-integration:onewayChannel?inOut=false"/>
</route>
</camelContext>

```

```

<channel id="requestChannel"/>
<channel id="responseChannel"/>

<beans:bean id="myProcessor"
class="org.apache.camel.component.spring.integration.MyProcessor"/>

<camelContext id="camel" xmlns="http://camel.apache.org/schema/spring">
<route>
<!-- Using the & as the separator of & -->
<from
uri="spring-integration://requestChannel?outputChannel=responseChannel&inOut=true"/>
<process ref="myProcessor"/>
</route>
</camelContext>

```

or by the Spring Integration Channel name

```

<beans:beans xmlns="http://www.springframework.org/schema/integration"
    xmlns:xsi="http://www.w3.org/2001/XMLSchema-instance"
    xmlns:beans="http://www.springframework.org/schema/beans"
    xsi:schemaLocation="http://www.springframework.org/schema/beans
        http://www.springframework.org/schema/beans/
spring-beans-2.5.xsd
        http://www.springframework.org/schema/integration
        http://www.springframework.org/schema/integration/
spring-integration-1.0.xsd
        http://camel.apache.org/schema/spring

```

```

        http://camel.apache.org/schema/spring/camel-spring.xsd">
    <channel id="outputChannel" />

    <camelContext id="camel" xmlns="http://camel.apache.org/schema/spring">
        <route>
            <!-- camel will create a spring integration endpoint automatically -->
            <from uri="outputChannel" />
            <to uri="mock:result" />
        </route>
    </camelContext>

```

## The Source and Target adapter

Spring Integration also provides the Spring Integration's Source and Target adapters which could route the message from the Spring Integration channel to a camel context endpoint or from a camel context endpoint to a Spring Integration Channel.

Here is the name spaces header

```

<beans:beans xmlns="http://www.springframework.org/schema/integration"
    xmlns:beans="http://www.springframework.org/schema/beans"
    xmlns:xsi="http://www.w3.org/2001/XMLSchema-instance"
    xmlns:camel-si="http://camel.apache.org/schema/spring/integration"
    xsi:schemaLocation="
        http://www.springframework.org/schema/beans
        http://www.springframework.org/schema/beans/spring-beans-2.5.xsd
        http://www.springframework.org/schema/integration
        http://www.springframework.org/schema/integration/spring-integration-1.0.xsd
        http://camel.apache.org/schema/spring/integration
        http://camel.apache.org/schema/spring/integration/camel-spring-integration.xsd
        http://camel.apache.org/schema/spring
        http://camel.apache.org/schema/spring/camel-spring.xsd
">

```

Now you could bind your source or target to camel context endpoint

```

<!-- Create the camel context here -->
<camelContext id="camelTargetContext" xmlns="http://camel.apache.org/schema/spring">
    <route>
        <from uri="direct:EndpointA" />
        <to uri="mock:result" />
    </route>
    <route>
        <from uri="direct:EndpointC" />
        <process ref="myProcessor" />
    </route>
</camelContext>

<!-- We can bind the camelTarget to the camel context's endpoint by specifying the
camelEndpointUri attribute -->
<camel-si:camelTarget id="camelTargetA" camelEndpointUri="direct:EndpointA"
expectReply="false">
    <camel-si:camelContextRef>camelTargetContext</camel-si:camelContextRef>
</camel-si:camelTarget>

```

```

<camel-si:camelTarget id="camelTargetB" camelEndpointUri="direct:EndpointC"
replyChannel="channelC" expectReply="true">
  <camel-si:camelContextRef>camelTargetContext</camel-si:camelContextRef>
</camel-si:camelTarget>

<camel-si:camelTarget id="camelTargetD" camelEndpointUri="direct:EndpointC"
expectReply="true">
  <camel-si:camelContextRef>camelTargetContext</camel-si:camelContextRef>
</camel-si:camelTarget>

<beans:bean id="myProcessor"
class="org.apache.camel.component.spring.integration.MyProcessor" />

```

---

```

<camelContext id="camelSourceContext" xmlns="http://camel.apache.org/schema/spring">
  <route>
    <from uri="direct:OneWay" />
    <to uri="direct:EndpointB" />
  </route>
  <route>
    <from uri="direct:TwoWay" />
    <to uri="direct:EndpointC" />
  </route>
</camelContext>

<!-- camelSource will redirect the message coming for direct:EndpointB to the spring
requestChannel channelA -->

<camel-si:camelSource id="camelSourceA" camelEndpointUri="direct:EndpointB"
requestChannel="channelA" expectReply="false">
  <camel-si:camelContextRef>camelSourceContext</camel-si:camelContextRef>
</camel-si:camelSource>

<!-- camelSource will redirect the message coming for direct:EndpointC to the spring
requestChannel channelB
then it will pull the response from channelC and put the response message back to
direct:EndpointC -->

<camel-si:camelSource id="camelSourceB" camelEndpointUri="direct:EndpointC"
requestChannel="channelB" replyChannel="channelC" expectReply="true">
  <camel-si:camelContextRef>camelSourceContext</camel-si:camelContextRef>
</camel-si:camelSource>

```

## See Also

- [Configuring Camel](#)
- [Component](#)
- [Endpoint](#)
- [Getting Started](#)

## STREAM COMPONENT

The **stream:** component provides access to the System.in, System.out and System.err streams together with allowing streaming of file and url.

### URI format

```
stream:in
stream:out
stream:err
stream:header
```

And the file and url is supported in **Camel 2.0:**

```
stream:file?fileName=/foo/bar.txt
stream:url
```

If the **stream:header** option is specified then the **stream** header is used to find the stream to write to. This option is only available for StreamProducer.

### Options

Name	Default Value	Description
delay	0	Initial delay in millis before consuming or producing the stream.
encoding	JVM Default	As of 1.4 or later you can configure the encoding (is a charset name) to use text based streams (eg. message body is a String object). If not provided Camel will use the JVM default Charset.
promptMessage	null	<b>Camel 2.0:</b> Leading prompt message that can be used when reading from stream:in to have a leading text such as <code>Enter a command:</code>
promptMessageDelay	0	<b>Camel 2.0:</b> Optional delay in millis before showing the prompt message. Can be used when system startup to avoid prompt message being written while other logging is done to the System out.
promptDelay	0	<b>Camel 2.0:</b> Optional delay in millis before showing the prompt message.

promptInitialDelay	2000	<b>Camel 2.0:</b> initial delay in millis before showing the prompt message. This delay only occurs once. Can be used when system startup to avoid prompt message being written while other logging is done to the System out.
fileName	null	<b>Camel 2.0:</b> When using the <b>stream:file</b> notation this specifies the file name to stream to/from.
scanStream	false	<b>Camel 2.0:</b> To be used for continuously reading a stream such as the unit tail command.
scanStreamDelay	0	<b>Camel 2.0:</b> Delay in millis between read attempts when using scanStream.

## Message content

The **stream:** component supports either String or byte[] for writing to streams. Just add to the message.in.body either a String or byte[] content.

The special **stream:header** URI is used for custom output streams. Just add a java.io.OutputStream to message.in.header in the key header.

See samples for an example.

## Samples

In this sample we output to System.out the content from the message when its put on the direct:in queue.

```
public void testStringContent() throws Exception {
    template.sendBody("direct:in", "Hello Text World\n");
}

public void testBinaryContent() {
    template.sendBody("direct:in", "Hello Bytes World\n".getBytes());
}

protected RouteBuilder createRouteBuilder() {
    return new RouteBuilder() {
        public void configure() {
            from("direct:in").to("stream:out");
        }
    };
}
```

This sample demonstrates how the header type can be used to determine which stream to use. In the sample we use our own output stream (MyOutputStream).

```
private OutputStream mystream = new MyOutputStream();
private StringBuffer sb = new StringBuffer();
```

```

public void testStringContent() {
    template.sendBody("direct:in", "Hello");
    // StreamProducer appends \n in text mode
    assertEquals("Hello\n", sb.toString());
}

public void testBinaryContent() {
    template.sendBody("direct:in", "Hello".getBytes());
    // StreamProducer is in binary mode so no \n is appended
    assertEquals("Hello", sb.toString());
}

protected RouteBuilder createRouteBuilder() {
    return new RouteBuilder() {
        public void configure() {
            from("direct:in").setHeader("stream", constant(mystream)).
                to("stream:header");
        }
    };
}

private class MyOutputStream extends OutputStream {

    public void write(int b) throws IOException {
        sb.append((char)b);
    }
}

```

This sample demonstrates how to continuously read a file stream such as the Unix tail command:

```

from("stream:file?fileName=/server/logs/
server.log?scanStream=true&scanStreamDelay=1000").to("bean:logService?method=parseLogLine");

```

## See Also

- [Configuring Camel](#)
- [Component](#)
- [Endpoint](#)
- [Getting Started](#)

## STRING TEMPLATE

The **string-template** component allows you to process a message using a String Template. This can be ideal when using Templating to generate responses for requests.

### URI format

```
string-template:templateName
```

Where **templateName** is the classpath-local URI of the template to invoke; or the complete URL of the remote template.

## Options

Option	Default	Description
contentCache	false	New option in Camel 1.4. Cache for the resource content when its loaded.

## Headers

Camel will store a reference to the resource in the message header in the key `org.apache.camel.stringtemplate.resource`. The Resource is an `org.springframework.core.io.Resource` object.

## Hot reloading

The stringtemplate resource is by default hot reloadable for both file and classpath resources (expanded jar). Setting the `contentCache=true` then Camel will only load the resource once, and thus hot reloading is not possible. This scenario can be used in production usage when the resource never changes.

## StringTemplate Attributes

Camel will provide exchange information as attributes (just a Map) to the string template. The Exchange is transferred as:

key	value
exchange	The Exchange itself
headers	The headers of the in message
camelContext	The Camel Context
request	The in message
in	The in message
body	The in message body
out	The out message (only for InOut message exchange pattern)
response	The out message (only for InOut message exchange pattern)

## Samples

For example you could use something like

```
from("activemq:My.Queue").
to("string-template:com/acme/MyResponse.tm");
```

To use a string template to formulate a response for a message

## The Email Sample

In this sample we want to use StringTemplate as templating for an order confirmation email. The email template is laid out in StringTemplate as:

```
Dear $headers.lastName$, $headers.firstName$

Thanks for the order of $headers.item$.

Regards Camel Riders Bookstore
$body$
```

And the java code:

```
private Exchange createLetter() {
    Exchange exchange = context.getEndpoint("direct:a").createExchange();
    Message msg = exchange.getIn();
    msg.setHeader("firstName", "Claus");
    msg.setHeader("lastName", "Ibsen");
    msg.setHeader("item", "Camel in Action");
    msg.setBody("PS: Next beer is on me, James");
    return exchange;
}

public void testVelocityLetter() throws Exception {
    MockEndpoint mock = getMockEndpoint("mock:result");
    mock.expectedMessageCount(1);
    mock.expectedBodiesReceived("Dear Ibsen, Claus\n\nThanks for the order of Camel in
Action.\n\nRegards Camel Riders Bookstore\nPS: Next beer is on me, James");

    template.send("direct:a", createLetter());

    mock.assertIsSatisfied();
}

protected RouteBuilder createRouteBuilder() throws Exception {
    return new RouteBuilder() {
        public void configure() throws Exception {
            from("direct:a").to("string-template:org/apache/camel/component/
stringtemplate/letter.tm").to("mock:result");
        }
    };
}
```



## See Also

- [Configuring Camel](#)
- [Component](#)
- [Endpoint](#)
- [Getting Started](#)

## TEST COMPONENT

Testing of distributed and asynchronous processing is notoriously difficult. The Mock, Test and DataSet endpoints work great with the Camel Testing Framework to simplify your unit and integration testing using Enterprise Integration Patterns and Camel's large range of Components together with the powerful Bean Integration.

The Test component extends the Mock component to support pulling messages from another endpoint on startup to set the expected message bodies on the underlying Mock endpoint.

i.e. you use the test endpoint in a route and messages arriving on it will be implicitly compared to some expected messages extracted from some other location.

So you can use for example an expected set of message bodies as files. This will then setup a properly configured Mock endpoint which is only valid if the received messages match the number of expected messages and their message payloads are equal.

### URI format

```
test:expectedMessagesEndpointUri
```

Where **expectedMessagesEndpointUri** refers to some other Component URI where the expected message bodies are pulled from before starting the test.

### Example

For example you could write a test case as follows

```
from("seda:someEndpoint").  
to("test:file://data/expectedOutput?noop=true");
```

If your test then invokes the `MockEndpoint.assertIsSatisfied(camelContext)` method then your test case will perform the necessary assertions.

Here is a real example test case using Mock and Spring along with its Spring XML.

To see how you can set other expectations on the test endpoint, see the Mock component.

## See Also

- [Configuring Camel](#)
- [Component](#)
- [Endpoint](#)

- Getting Started
- Spring Testing

## TIMER COMPONENT

The **timer:** component is used to generate message exchanges when a timer fires. You can only consume events from this endpoint.

### URI format

```
timer:name?options
```

Where name of the Timer object which is created and shared across endpoints. So if you use the same name for all your timer endpoints then only one Timer object & thread will be used.

**Notice:** The IN body of the generated exchange is null. So `exchange.getIn().getBody()` returns null.

### Options

Where **options** is a query string that can specify any of the following parameters:

Name	Default Value	Description
time	null	A <code>java.util.Date</code> the <b>first</b> event should be generated
period	1000	If greater than 0, then generate periodic events every period milliseconds
delay	0	The number of milliseconds to wait before the first event is generated. Should not be used in conjunction with the time parameter.
fixedRate	false	Events take place at approximately regular intervals, separated by the specified period
daemon	true	Should the thread associated with the timer endpoint be run as a daemon

### Exchange Properties

When the timer is fired it adds the following information as properties to the Exchange.

Name	Type	Description
<code>org.apache.camel.timer.name</code>	String	the name option



## Advanced Scheduler

See also the Quartz component that supports much more advanced scheduling.

org.apache.camel.timer.time	Date	the time option
org.apache.camel.timer.period	long	the period option
org.apache.camel.timer.firedTime	Date	<b>Camel 1.5:</b> the current time when the consumer fired

## Message Headers

When the timer is fired it adds the following information as headers to the IN message

Name	Type	Description
firedTime	Date	Camel 1.5: the current time when the consumer fired

## Sample

To setup a route that generates an event every 60 seconds:

```
from("timer://foo?fixedRate=true&period=60000").to("bean:myBean?method=someMethodName");
```

The above route will generate an event then invoke the someMethodName on the bean called myBean in the Registry such as JNDI or Spring.

And the route in Spring DSL:

```
<route>
  <from uri="timer://foo?fixedRate=true&period=60000"/>
  <to uri="bean:myBean?method=someMethodName"/>
</route>
```

## See Also

- [Configuring Camel](#)
- [Component](#)
- [Endpoint](#)
- [Getting Started](#)
- [Quartz](#)

## VALIDATION COMPONENT

The Validation component performs XML validation of the message body using the JAXP Validation API using any of the supported XML schema languages, which defaults to XML Schema

Note that the Jing component also supports the following schema languages which are useful

- RelaxNG Compact Syntax
- RelaxNG XML Syntax

The MSV component also supports RelaxNG XML Syntax.

### URI format

```
validator:someLocalOrRemoteResource
```

Where **someLocalOrRemoteResource** is some URL to a local resource on the classpath or a full URL to a remote resource or resource on the file system which contains the XSD to validate against. For example

- msv:org/foo/bar.xsd
- msv:file:../foo/bar.xsd
- msv:http://acme.com/cheese.xsd
- validator:com/mypackage/myschema.xsd

### Example

The following example shows how to configure a route from endpoint **direct:start** which then goes to one of two endpoints, either **mock:valid** or **mock:invalid** based on whether or not the XML matches the given schema (which is supplied on the classpath).

```
<camelContext xmlns="http://camel.apache.org/schema/spring">
  <route>
    <from uri="direct:start" />
    <try>
      <to uri="validator:org/apache/camel/component/validator/schema.xsd" />
      <to uri="mock:valid" />

      <catch>
        <exception>org.apache.camel.ValidationException</exception>
        <to uri="mock:invalid" />
      </catch>
    </try>
  </route>
</camelContext>
```

### See Also

- Configuring Camel
- Component

- Endpoint
- Getting Started

## VELOCITY

The **velocity** component allows you to process a message using an Apache Velocity template. This can be ideal when using Templating to generate responses for requests.

### URI format

```
velocity:templateName
```

Where **templateName** is the classpath-local URI of the template to invoke; or the complete URL of the remote template (eg: file://folder/myfile.vm).

### Options

Option	Default	Description
loaderCache	true	Velocity based file loader cache
contentCache		New option in Camel 1.4. Cache for the resource content when its loaded. Is default false in Camel 1.x. Is default true in Camel 2.x.
encoding	null	New option in Camel 1.6. Character encoding of the resource content.

### Headers

Camel will store a reference to the resource in the message header in the key `org.apache.camel.velocity.resource`. The Resource is an `org.springframework.core.io.Resource` object. And the key `org.apache.camel.velocity.resourceUri` holds the **templateName** as a String object.

In Camel 1.4 headers set during the velocity evaluation is returned to the message and added as headers. Then its kinda possible to return values from Velocity to the Message.

An example: Set the header value of fruit in the Velocity template .tm:

```
$in.setHeader('fruit', 'Apple')
```

The header 'fruit' is now accessible from the `message.out.headers`.

## Velocity Context

Camel will provide exchange information in the Velocity context (just a Map). The Exchange is transferred as:

key	value
exchange	The Exchange itself
headers	The headers of the in message
camelContext	The Camel Context
request	The in message
in	The in message
body	The in message body
out	The out message (only for InOut message exchange pattern)
response	The out message (only for InOut message exchange pattern)

## Hot reloading

The velocity template resource is by default hot reloadable for both file and classpath resources (expanded jar). Setting the `contentCache=true` then Camel will only load the resource once, and thus hot reloading is not possible. This scenario can be used in production usage when the resource never changes.

## Samples

For example you could use something like

```
from("activemq:My.Queue").
  to("velocity:com/acme/MyResponse.vm");
```

To use a velocity template to formulate a response for a message for InOut message exchanges (where there is a `JMSReplyTo` header).

If you want to use `InOnly` and consume the message and send it to another destination you could use

```
from("activemq:My.Queue").
  to("velocity:com/acme/MyResponse.vm").
  to("activemq:Another.Queue");
```

And to use content cache, eg. for production usage where the `.vm` template never changes:

```
from("activemq:My.Queue").
  to("velocity:com/acme/MyResponse.vm?contentCache=true").
  to("activemq:Another.Queue");
```

And a file based resource:

```
from("activemq:My.Queue").
  to("velocity:file://myfolder/MyResponse.vm?contentCache=true").
  to("activemq:Another.Queue");
```

## The Email Sample

In this sample we want to use Velocity as templating for an order confirmation email. The email template is laid out in Velocity as:

```
Dear ${headers.lastName}, ${headers.firstName}

Thanks for the order of ${headers.item}.

Regards Camel Riders Bookstore
${body}
```

And the java code:

```
private Exchange createLetter() {
    Exchange exchange = context.getEndpoint("direct:a").createExchange();
    Message msg = exchange.getIn();
    msg.setHeader("firstName", "Claus");
    msg.setHeader("lastName", "Ibsen");
    msg.setHeader("item", "Camel in Action");
    msg.setBody("PS: Next beer is on me, James");
    return exchange;
}

public void testVelocityLetter() throws Exception {
    MockEndpoint mock = getMockEndpoint("mock:result");
    mock.expectedMessageCount(1);
    mock.expectedBodiesReceived("Dear Ibsen, Claus\n\nThanks for the order of Camel in
Action.\n\nRegards Camel Riders Bookstore\nPS: Next beer is on me, James");

    template.send("direct:a", createLetter());

    mock.assertIsSatisfied();
}

protected RouteBuilder createRouteBuilder() throws Exception {
    return new RouteBuilder() {
        public void configure() throws Exception {
            from("direct:a").to("velocity:org/apache/camel/component/velocity/
letter.vm").to("mock:result");
        }
    };
}
```

## See Also

- [Configuring Camel](#)
- [Component](#)
- [Endpoint](#)

- Getting Started

## VM COMPONENT

The **vm:** component provides asynchronous SEDA behavior so that messages are exchanged on a `BlockingQueue` and consumers are invoked in a separate thread pool to the producer.

This component differs from the Seda component in that VM supports communication across `CamelContext` instances so you can use this mechanism to communicate across web applications, provided that the `camel-core.jar` is on the system/boot classpath.

This component is an extension to the Seda component.

### URI format

```
vm:someName
```

Where **someName** can be any string to uniquely identify the endpoint within the JVM (or at least within the classloader which loaded the `camel-core.jar`)

### Options

Name	Default	Description
size	1000	The maximum size of the SEDA queue

### Samples

In the route below we send the exchange to the VM queue that is working across `CamelContext` instances.

```
from("direct:in").bean(MyOrderBean.class).to("vm:order.email");
```

And then in another Camel context such as deployed as in another `.war` application:

```
from("vm:order.email").bean(MyOrderEmailSender.class);
```

### See Also

- Configuring Camel
- Component
- Endpoint
- Getting Started
- Seda



## XMPP COMPONENT

The **xmpp:** component implements an XMPP (jabber) transport.

### URI format

```
xmpp://[login@]hostname[:port]/[participant][?Options]
```

The component supports both room based and private person-person conversations. The component supports both producer and consumer (you can get messages from xmpp or send messages to xmpp). Consumer mode supports rooms starting from camel-1.5.0.

### Options

Name	Description
room	If room is specified then component will connect to MUC (Multi User Chat). Usually domain name for MUC is different from login domain. For example if you are superman@jabber.org and want to join "krypton" room then room url is krypton@conference.jabber.org. Note "conference" part. Starting from camel-1.5.0 it is not required to provide full room JID. If room parameter does not contain "@" symbol then domain part will be discovered and added by Camel
user	User name (without server name). If not specified then anonymous login attempt will be performed.
password	Password
resource	XMPP resource. The default is "Camel"
createAccount	If "true" then an attempt to create an account will be made. Default is <b>false</b>
participant	JID (jabber ID) of person to receive messages. "room" parameter has precedence over "participant".
nickname	Use nick when joining room. If room is specified and nickname is not then "user" will be used for nick
serviceName	<b>Camel 1.6/2.0</b> The name of the service you are connecting to. For Google Talk, this would be gmail.com

### Examples

User "superman" to join room krypton at jabber server with password "secret".

```
xmpp://superman@jabber.org/?room=krypton@conference.jabber.org&password=secret
```

User "superman" to send messages to joker

```
xmpp://superman@jabber.org/joker@jabber.org?password=secret
```

Routing example in Java

```
from("timer://kickoff?period=10000").  
setBody(constant("I will win!\n Your Superman.")).  
to("xmpp://superman@jabber.org/joker@jabber.org?password=secret");
```

Consumer configuration. Will write all messages from Joker into a queue "evil.talk".

```
from("xmpp://superman@jabber.org/joker@jabber.org?password=secret").  
to("activemq:evil.talk");
```

Consumer configuration listening to a room messages (supported from camel-1.5.0)

```
from("xmpp://superman@jabber.org/?password=secret&room=krypton@conference.jabber.org").  
to("activemq:krypton.talk");
```

Room in short notation (no domain part; for camel-1.5.0+)

```
from("xmpp://superman@jabber.org/?password=secret&room=krypton").  
to("activemq:krypton.talk");
```

When connecting to the Google Chat service, you'll need to specify the serviceName as well as your credentials (as of **Camel 1.6/2.0**)

```
// send a message from fromuser@gmail.com to touser@gmail.com  
from("direct:start").  
to("xmpp://talk.google.com:5222/  
touser@gmail.com?serviceName=gmail.com&user=fromuser&password=secret").  
to("mock:result");
```

## See Also

- Configuring Camel
- Component
- Endpoint
- Getting Started

## XQUERY

The **xquery** component allows you to process a message using an XQuery template. This can be ideal when using Templating to generate responses for requests.

### URI format

```
xquery:templateName
```

Where **templateName** is the classpath-local URI of the template to invoke; or the complete URL of the remote template.

For example you could use something like

```
from("activemq:My.Queue").
  to("xquery:com/acme/mytransform.xquery");
```

To use a xquery template to formulate a response for a message for InOut message exchanges (where there is a JMSReplyTo header).

If you want to use InOnly and consume the message and send it to another destination you could use

```
from("activemq:My.Queue").
  to("xquery:com/acme/mytransform.xquery").
  to("activemq:Another.Queue");
```

## Options

Name	Default Value	Description
------	---------------	-------------

## See Also

- [Configuring Camel](#)
- [Component](#)
- [Endpoint](#)
- [Getting Started](#)

## XSLT

The **xslt** component allows you to process a message using an XSLT template. This can be ideal when using Templating to generate responses for requests.

### URI format

```
xslt:templateName
```

Where **templateName** is the classpath-local URI of the template to invoke; or the complete URL of the remote template. Refer to the Spring Documentation for more detail of the URI syntax

Here are some example URIs

URI	Description
<pre>xslt:com/acme/mytransform.xml</pre>	refers to the file com/acme/mytransform.xml on the classpath
<pre>xslt:file:///foo/bar.xml</pre>	refers to the file /foo/bar.xml

```
xslt:http://acme.com/cheese/  
foo.xsl
```

refers to the remote http resource

## Using XSLT endpoints

For example you could use something like

```
from("activemq:My.Queue").  
to("xslt:com/acme/mytransform.xsl");
```

To use a xslt template to formulate a response for a message for InOut message exchanges (where there is a JMSReplyTo header).

If you want to use InOnly and consume the message and send it to another destination you could use

```
from("activemq:My.Queue").  
to("xslt:com/acme/mytransform.xsl").  
to("activemq:Another.Queue");
```

## Getting Parameters into the XSLT to work with

By default, all headers are added as parameters which are available in the XSLT.

To do this you will need to declare the parameter so it is then 'useable'.

```
<setHeader headerName="myParam"><constant>42</constant></setHeader>  
<to uri="xslt:MyTransform.xsl"/>
```

and the XSLT just needs to declare it at the top level for it to be available.

```
<xsl: ..... >  
  
  <xsl:param name="myParam"/>  
  
  <xsl:template ...>
```

## Spring XML versions

To use the above examples in Spring XML you would use something like

```
<camelContext xmlns="http://activemq.apache.org/camel/schema/spring">  
  <route>  
    <from uri="activemq:My.Queue"/>  
    <to uri="xslt:org/apache/camel/spring/processor/example.xsl"/>  
    <to uri="activemq:Another.Queue"/>  
  </route>  
</camelContext>
```

There is a test case along with its Spring XML if you want a concrete example.

## Options

Name	Default Value	Description
converter	null	Option to override default XmlConverter. Will lookup for the converter in the Registry. The provided converted must be of type <code>org.apache.camel.converter.jaxp.XmlConverter</code> .
transformerFactory	null	<b>New added in Camel 1.6</b> Option to override default TransformerFactory. Will lookup for the transformerFactory in the Registry. The provided transformer factory must be of type <code>javax.xml.transform.TransformerFactory</code> .
transformerFactoryClass	null	<b>New added in Camel 1.6</b> Option to override default TransformerFactory. Will create a <code>TransformerFactoryClass</code> instance and set it to the coverter.

## See Also

- [Configuring Camel](#)
- [Component](#)
- [Endpoint](#)
- [Getting Started](#)